

ENC

ISO Quality Management System Authentication

CE

Service Manual

EN500/600 series

Ver.2.0



SHENZHEN ENCOM ELECTRIC TECHNOLOGIES CO.,LTD.

Foreword

Thank you for purchasing EN500/EN600 series inverter developed and produced by Shenzhen Encom Electric Technologies CO., LTD.

EN500/EN600 series hi-performance flux vector inverter adopt advanced control mode to achieve high torque, high precision and wide-range speed regulation drive, and it also support speed sensorless torque control and PG control torque. It can meet customer all kinds of requirement to universal inverter. EN500/EN600 inverter is a organic combination for customer's universal and industrial control purpose and provide practical main-auxiliary frequency provision, run channel frequency binding, PID regulator, simple PLC, spinning traverse, programmable input&output terminal control, pulse frequency provision and inbuilt Modbus, Can bus, Profibus, 485 freedom protocol and other function and platform. It provide high integration solution for most manufacturing and automation customer and EN500/EN600 inbuilt input phase loss function, output phase loss function, short circuit to earth grounding function and many other protective function to improve effectively the system reliability and safety.

This brochure provide the installation and wiring, settings, fault check and methods, maintenance and other relative issues to customer. To make inverter assemble and operate rightly, and use its high performance to best, please read this brochure carefully before installation usage and keep them well to the final users of inverter.

Please contact our office or dealer anywhere at any moment when you have any doubts or special demands in using these inverters, and you can also contact our after service center in our Headquarters directly. We will serve you with all our heart.

We reserve our right to notice you if we change contents of this manual.

Content

1	Safety information and use notice points	1
1.1	Safety precautions	1
1.2	Application range	3
1.3	Use notice points	3
1.4	Scraping handling notice	4
2	Inverter type and specification	5
2.1	Incoming inverter inspect	5
2.2	Type explanation	5
2.3	Nameplate explanation	5
2.4	Inverter type explanation	6
2.5	Appearance and parts name explanation	7
2.6	Outer size	8
2.7	EN500 optional base	10
2.8	Outer size of keypad and its fixing box	12
2.9	Product technic index and spec	13
3	Installation and wiring	16
3.1	Installation ambient	16
3.1.1	The demands for installation ambient	16
3.1.2	Installation direction and space	16
3.2	Parts disassembly and installation	17
3.2.1	Keyboard disassembly and installation	17
3.2.2	Cover disassembly and installation	17
3.3	Wiring notice points	18
3.4	Main loop terminal wiring	19
3.4.1	Connection between inverter and fitting parts	21
3.4.2	Main loop terminal wiring	21
3.5	Basic running wiring diagram	25
3.6	Control loop collocation and wiring	25
3.6.1	Relative location and function for control board terminal and slide switch	25

3.6.2	Descriptions for control board terminal	27
3.6.3	Analog input&output terminal wiring.....	29
3.6.4	Digital input terminal wiring	30
3.6.5	Communication terminal wiring.....	32
4	EMC (Electromagnetic compatibility) explanation	34
4.1	Noise interference restraining.....	34
4.1.1	Interference noise type	34
4.1.2	Basic countermeasure for restrain interference	35
4.2	Field wiring and earth grounding	36
4.3	Leak current and countermeasure	36
4.4	Installation demand for electromagnetic on-off electronic device.....	37
4.5	Noise filter installation instructions	37
5	Run and operation explanation for inverter	38
5.1	Run of inverter	38
5.1.1	Running order channels	38
5.1.2	Frequency-provision channel	38
5.1.3	Work state	39
5.1.4	Run mode	40
5.2	Operation and use of key board	42
5.2.1	Keypad layout.....	42
5.2.2	Keypad function description	42
5.2.3	LED and indicator light	43
5.2.4	Key board display status	43
5.2.5	User Management Parameters.....	46
5.2.6	Method for operating keypad	46
5.3	Inverter electrification	49
5.3.1	Check before electrification	49
5.3.2	First electrification.....	49
6	Function parameter schedule graph	50
6.1	Symbol description.....	50
6.2	Function parameter schedule graph	50

7	Detailed function specification	90
	7.1 System Parameter Group: F00	90
	7.2 Basic Run Function Parameter Group:F01.....	99
	7.3 Start, stop, forward/reverse, brake function parameter group: F02.....	108
	7.4 V/F control parameter group: F03	114
	7.5 Auxiliary running parameter group: F04	117
	7.6 Communication control parameter group: F05	123
	7.7 Setting curve parameter group: F06	128
	7.8 Analog quantity, Pulse input function parameter group: F07.....	132
	7.9 On-off input function parameter group: F08	135
	7.10 Switch output function parameter group: F09	150
	7.11 Simple PLC/Multi-speed function parameters Group:F10	161
	7.12 Closed-Loop PID operation Parameters Group:F11.....	168
	7.13 Constant pressure water supply function parameters Group: F12.....	175
	7.14 Traverse, Fixed-length control Function Parameters Group: F13.....	178
	7.15 Vector Control parameters Group: F14	182
	7.16 Motor parameters Group: F15	187
	7.17 Closed-loop encoder parameters Group: F16	190
	7.18 Reserved parameters Group1:F17.....	191
	7.19 Enhanced Control Functions Parameters Group: F18	192
	7.20 Protective Relevant Function Parameters Group:F19	195
	7.21 Internal Virtual Input Output Node Parameter Group: F20	206
	7.22 Reserved parameter group 2:F21	209
	7.23 Reserved parameter group 3:F22	209
	7.24 Reserved parameter group 4:F23	209
	7.25 Reserved parameter group 5:F24	209
	7.26 User Definition Display Parameter Group: F25	210
	7.27 Fault Record Function Parameter Group: F26	212
	7.28 Password and Manufacturer Function Parameter Group: F27	214
8	Troubleshooting	215



8.1 Failure and countermeasure	215
8.2 Failure record lookup	220
8.3 Failure reset	220
8.4 Alarm reset	221
9 Maintenance	222
9.1 Routine maintenance	222
9.2 Inspection and replacement of damageable parts	222
9.3 Repair guarantee	223
9.4 Storage	224
Appendix A Modbus communication protocol	225
Appendix B Free-port communication protocol	239
Appendix C Keyboard	251
C.1 Keyboard selection	251
C.2 LED double display keyboard	251
C.3 LCD keyboard	252
C.4 LED single-display digital potentiometer keyboard	257
C.5 Communication Component	258
Appendix D Communication extension card	259
D.1 Communication card selection	259
D.2 PROFIBUS-DP communication card	259
D.3 CANopen communication card	262
D.4 CANlink communication card	264
Appendix E Universal encoder expansion card	266
Appendix F Braking unit and braking resistance	268

1 Safety information and use notice points

To make ensure personal & equipment safety, this chapter must be read carefully before the inverter come into use.

1.1 Safety precautions

There are three kinds of safety warnings in this manual as below:

Symbol	Symbol description
	It may cause human death, serious injury or heavy property loss with wrong operation.
	It may result body or device damage with wrong and timeless precautions under operation.
 Note	Should pay extra cautions when inverter in use under this symbol



Forbid to cut off the power source directly when inverter under running, acceleration or deceleration status. Power source could cut off when inverter completely in halt and standby status. Otherwise user should be responsible for inverter and device damage and human injury.



- (1) Forbid to connect AC power source to output terminal U,V,W, otherwise it could cause inverter completely damage.**
- (2) Not allow for short circuit between(-)and(+), otherwise it could cause inverter damage and power source short circuit.**
- (3) Forbid to install inverter on flammable objects, otherwise it may cause fire.**
- (4) Do not install inverter in a environment with explosive gas, it may cause explosion.**
- (5) Bare connection terminal should be insulation treatment after main loop connection, otherwise it may cause electric shock.**
- (6) Do not operate inverter with wet hands when inverter power on, otherwise it may cause electric shock.**
- (7) Inverter earth terminal should be well grounding connection.**
- (8) Do not open the front cover for wiring when inverter power on. Inverter wiring and check must handle after 10 minutes of inverter power off.**
- (9) Wiring connection should handle by qualified person and not allow to slip any conductive objects inside inverter, otherwise it may cause a electric shock or inverter damage.**
- (10) when inverter stocked for more than 6 months, using voltage regulator to boost voltage up and keep inverter in standby status for 1 hour, otherwise it may cause electric shock and explosion.**



- (1) Forbid to connect control terminals except TA, TB, TC to AC 220V/380V signal, otherwise it may cause inverter completely damage.**
- (2) Do not install and run inverter when inverter damage or spare part less, otherwise it may cause fire or human injury.**
- (3) inverter should install in a place where can accept itself weight, otherwise it may cause inverter drop down or belongings damage.**

1.2 Application range

- (1) This kind of inverter apply to 3 phase ac asynchronous motor only for general industry.
- (2) It should handle cautiously and consult with manufacturer when inverter apply to high reliability required equipment which relevant to life, properties and safety device.
- (3) This kind of inverter is the general motor control device in industry. When inverter apply to dangerous equipment, safeguard should be considerable in case of inverter failure.

1.3 Use notice points

- (1) EN500/EN600 series inverter belong to voltage type inverter, and it is normal with up temperature, noise and vibration of motor increasing over power frequency run slightly.
- (2) It is required to match inverter with variable frequency motor running at low speed with constant torque for long time. When match inverter with general asynchronous motor running at low speed, it should take measures to make motor heat dissipation or monitoring motor temperature in avoid of motor flash.
- (3) It is necessary to take measures in advance for the damage caused for the bad lubrication of the reduction box and wheel gear mechanical devices running at low speed for long time.
- (4) It is necessary to assure at first that the use speed range of motor bearings and mechanical devices, also the increasing of motor vibration and noise should be considered, when motor run over rated frequency.
- (5) It is necessary to select the suitable brake assembly for hoisting device and big inertia load to make sure the normal work when inverter stripping from power grid for the overcurrent or overvoltage failure.
- (6) Inverter start and stop control through terminal or other normal command channel, otherwise it may cause inverter damage via connecting inverter input terminal to big current switch just like contactor direct to start and stop inverter frequently.
- (7) It is necessary to make sure inverter cut off from operation without output, when inverter and motor connect through switch components just like contactor etc. Otherwise it will cause inverter damage.
- (8) When inverter output frequency within some range, it may meet mechanical resonance point of load device, through setting jump frequency to avoid it.
- (9) Checking power supply voltage within allowed working range before usage, otherwise, it need to change voltage or custom special voltage inverter.

(10)When inverter usage site altitude over1000 meters, inverter should derate current to use, output current decrease about 10% of rated current per 1000 meters increase.

(11)Motor should do insulation check before first usage or reuse after lay aside for long time. Checking method show as graph 1-1 below with 500V voltage type megohm meter , insulation resistance should not smaller than 5 MΩ, otherwise inverter maybe damaged.

(12)Forbid inverter output side to assemble capacitor to improve power factor or anti-thunder dependent resistor etc, otherwise it may cause inverter fault trip or component damage show as graph 1-2.

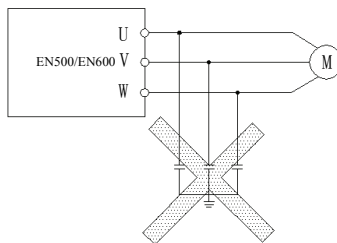
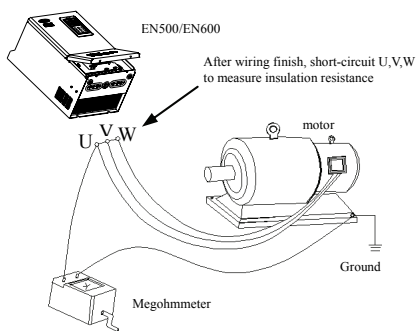

Fig.1-1 motor insulation check Fig.1-2 capacitor at output side forbidden

1.4 Scraping handling notice:

Notices when handling with scrapped inverter and components:

- (1) The unit: dispose the inverter as industrial waste.
- (2) Electrolytic capacitor: It may cause explosion when electrolytic capacitor under burning.
- (3)Plastic: it may result in harmful and poisonous gas when plastic and rubber of inverter burning, and safeguard preparations should be taken before burning.

2 Inverter type and specification

2.1 Incoming inverter inspect

- (1) Check if there is damage during transportation and inverter itself has damage or fall-off parts.
- (2) Check if parts presented in packing list are all ready.
- (3) Please confirm nameplate data of the inverter is in line with your order requirement.

Our product is guaranteed by strict quality system during manufacturing, packing, transportation etc., please contact our company or local agent rapidly if some careless omission or mistake arise, we'll deal with it as soon as possible.

2.2 Type explanation

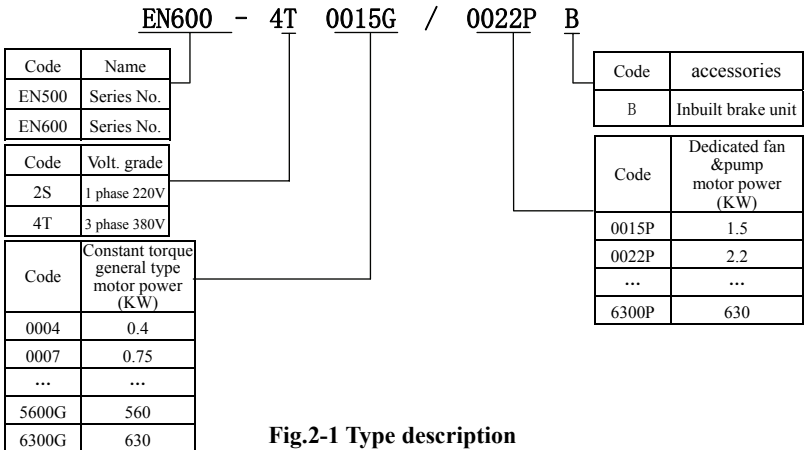

Fig.2-1 Type description

2.3 Nameplate explanation

Nameplate presented as figure 2-2 with type and rating data at the bottom of inverter right side.

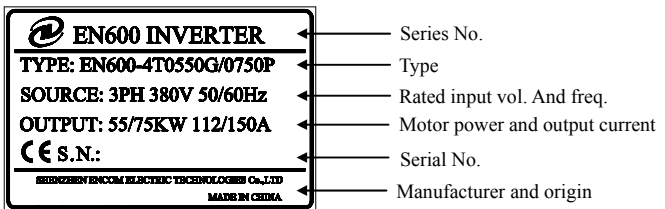

Fig.2-2 Nameplate

2.4 Inverter type explanation

Input Voltage	Inverter type	Rated output Current(A)	Adaptable motor (KW)
1 phase 220V	EN600-2S0004	2.5	0.4
	EN600-2S0007	4	0.75
	EN600-2S0015	7	1.5
	EN600-2S0022	10	2.2
	EN600-2S0037	15	3.7
3 phase 380V	EN600-4T0007G/0015P	2.3/3.7	0.75/1.5
	EN600-4T0015G/0022P	3.7/5	1.5/2.2
	EN600-4T0022G/0037P	5/8.5	2.2/3.7
	EN600-4T0037G	8.5	3.7
	EN600-4T0055P	13	5.5
	EN600-4T0055G/0075P	13/17	5.5/7.5
	EN600-4T0075G/0110P	17/25	7.5/11
	EN600-4T0110G/0150P	25/33	11/15
	EN600-4T0150G/0185P	33/39	15/18.5
	EN600-4T0185G/0220P	39/45	18.5/22
	EN600-4T0220G/0300P	45/60	22/30
	EN600-4T0300G/0370P	60/75	30/37
	EN600-4T0370G/0450P	75/91	37/45
	EN600-4T0450G/0550P	91/112	45/55
	EN600-4T0550G/0750P	112/150	55/75
	EN500-4T0750G/0900P	150/176	75/90
	EN500-4T0900G/1100P	176/210	90/110
	EN500-4T1100G/1320P	210/253	110/132
	EN500-4T1320G/1600P	253/304	132/160
	EN500-4T1600G/2000P	304/380	160/200
	EN500-4T2000G/2200P	380/426	200/220
	EN500-4T2200G/2500P	426/474	220/250
	EN500-4T2500G/2800P	474/520	250/280
	EN500-4T2800G/3150P	520/600	280/315
EN500-4T3150G/3550P	600/650	315/355	
EN500-4T3550G/3750P	650/680	355/375	
EN500-4T3750G/4000P	680/750	375/400	
EN500-4T4000G/4500P	750/800	400/450	

EN500-4T4500G/5000P	800/870	450/500
EN500-4T5000G/5600P	870/940	500/560
EN500-4T5600G/6300P	940/1100	560/630
EN500-4T6300G	1100	630

2.5 Appearance and parts name explanation

2.5.1 EN600 Appearance and parts name explanation

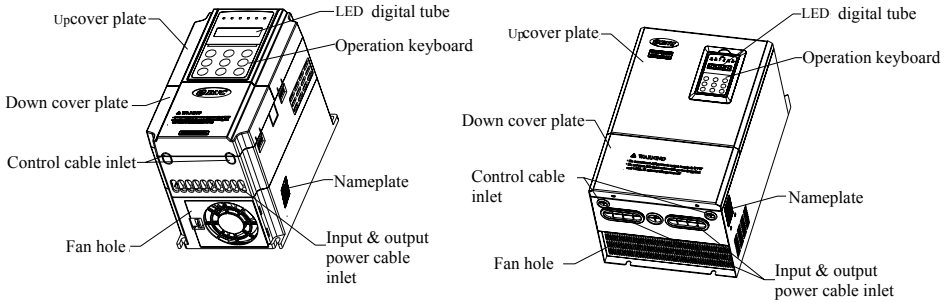

Fig.2-3 EN600 Parts name sketch

2.5.2 EN500 Appearance and parts name explanation

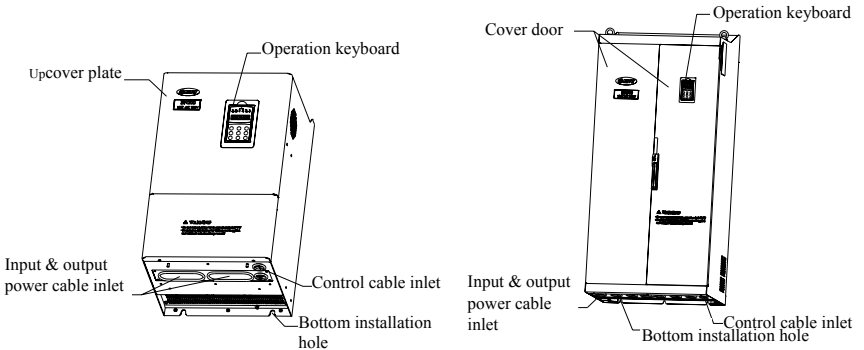

Fig.2-4 EN500 Parts name sketch

2.6 Outer size

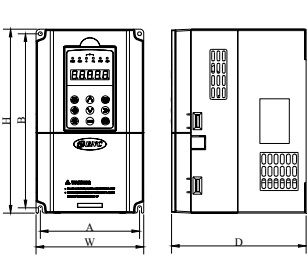

Fig.a

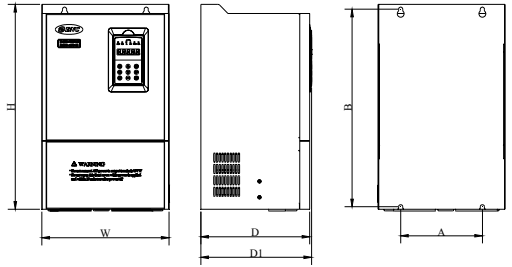

Fig.b

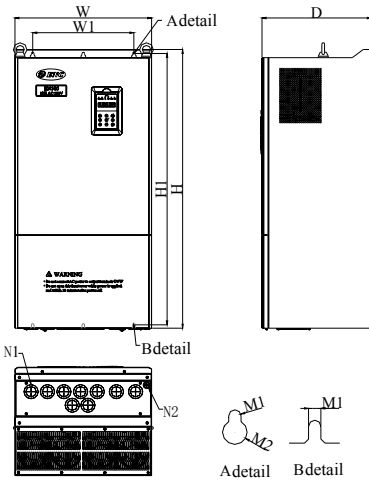

Fig.c

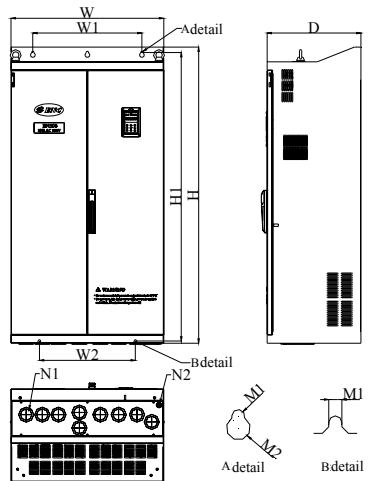

Fig.d

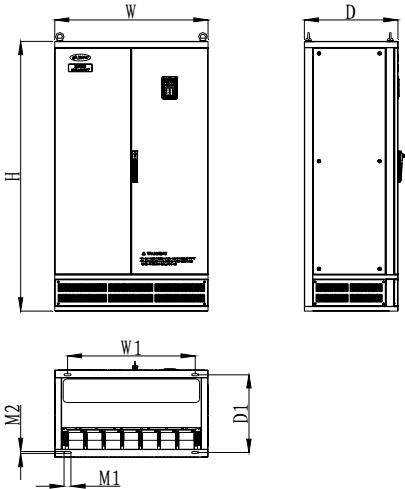

Fig.e

Fig.2-5 outer dimension

Table 2-1 EN600 mounting size

Inverter type	A (mm)	B (mm)	W (mm)	H (mm)	D (mm)	D1 (mm)	Fix Hole (mm)	Fig. No.
EN600-2S0004	104	186	115	200	151	-	5	Fig.a
EN600-2S0007								
EN600-2S0015								
EN600-2S0022								
EN600-2S0037	129	227	140	240	175	-	5	Fig.a
EN600-4T0007G/0015P	104	186	115	200	151	-	5	Fig.a
EN600-4T0015G/0022P								
EN600-4T0022G/0037P								
EN600-4T0037G								
EN600-4T0055P	129	227	140	240	175	-	5	Fig.a
EN600-4T0055G/0075P								
EN600-4T0075G/0110P								
EN600-4T0110G/0150P	165	281	180	304	189	-	6	Fig.a
EN600-4T0150G/0185P								
EN600-4T0185G/0220P	180	382	250	398	210	214	9	Fig.b
EN600-4T0220G/0300P								
EN600-4T0300G/0370P	180	434	280	450	240	244	9	Fig.b
EN600-4T0370G/0450P								

2 Inverter type and specification

EN600-4T0450G/0550P	190	504.5	290	530	250	254	9	Fig.b
EN600-4T0550G/0750P								

Table 2-2 EN500 mounting size

Inverter type	H (mm)	H1 (mm)	W (mm)	W1 (mm)	W2 (mm)	D (mm)	D1 (mm)	N1 (mm)	N2 (mm)	M1 (mm)	M2 (mm)	Fig. No.
EN500-4T0750G/0900P	570	546	340	237	-	320	-	-	-	Φ12	Φ18	Fig.c
EN500-4T0900G/1100P												
EN500-4T1100G/1320P	650	628	400	297	-	340	-	-	-	Φ12	Φ18	
EN500-4T1320G/1600P												
EN500-4T1600G/2000P	980	953	480	370	-	400	-	Φ38	Φ19	Φ9	Φ18	
EN500-4T2000G/2200P	1030	1003	500	370	-	400	-	Φ38	Φ19	Φ9	Φ18	
EN500-4T2200G/2500P												
EN500-4T2500G/2800P	1368	1322	700	500	440	430	-	Φ52	Φ19	Φ12	Φ22	Fig.d
EN500-4T2800G/3150P												
EN500-4T3150G/3550P												
EN500-4T3550G/3750P	1518	1483	700	500	500	430	-	OB 77*47	Φ19	Φ12	Φ22	
EN500-4T3750G/4000P												
EN500-4T4000G/4500P												
EN500-4T4500G/5000P												
EN500-4T5000G/5600P	1650	-	850	700	-	550	490	-	-	40	Φ13	Fig.e
EN500-4T5600G/6300P												
EN500-4T6300G	1700	-	900	750	-	550	490	-	-	40	Φ13	

2.7 EN500 optional base

2.7.1 EN500 inverter and base selection table

Type	Base model			
	Standard base	base with Input reactor	Base with output reactor	base with DC reactor
EN500-4T0750G/0900P	SP-BS-0900	SP-BS-0750-LI	SP-BS-0900-LO	SP-BS-0750-LD
EN500-4T0900G/1100P		SP-BS-0900-LI	SP-BS-0900-LO	-
EN500-4T1100G/1320P	SP-BS-1320	SP-BS-1100-LI	SP-BS-1100-LO	-
EN500-4T1320G/1600P		SP-BS-1320-LI	SP-BS-1320-LO	-
EN500-4T1600G/2000P	SP-BS-1600	SP-BS-1600-LI	SP-BS-1600-LO	-
EN500-4T2000G/2200P	SP-BS-2200	SP-BS-2000-LI	SP-BS-2000-LO	-
EN500-4T2200G/2500P		SP-BS-2200-LI	SP-BS-2200-LO	-
EN500-4T2500G/2800P	SP-BS-4000	SP-BS-2500-LI	SP-BS-2500-LO	-
EN500-4T2800G/3150P		SP-BS-2800-LI	SP-BS-2800-LO	-
EN500-4T3150G/3550P		SP-BS-3150-LI	SP-BS-3150-LO	-
EN500-4T3550G/3750P		SP-BS-4000-LI	SP-BS-4000-LO	-

EN500-4T3750G/4000P		SP-BS-4000-LI	SP-BS-4000-LO	-
EN500-4T4000G/4500P		SP-BS-4000-LI	SP-BS-4000-LO	-

2.7.2 Base outer dimension

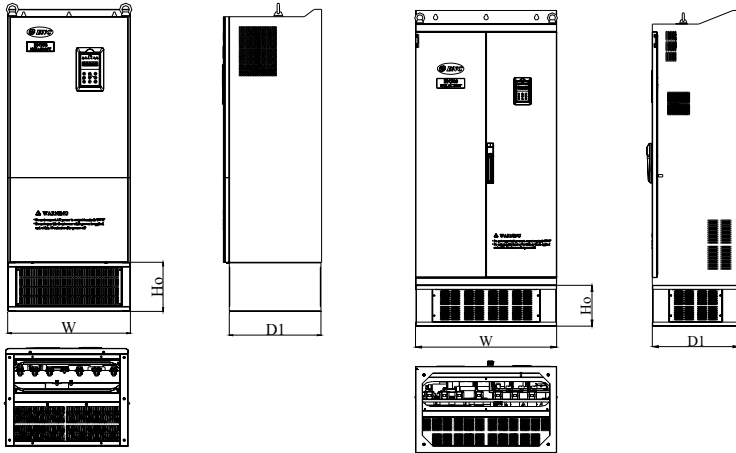

Fig.a

Fig.b

Fig.2-6 base dimension

Table 2-3 base size

Base model	W (mm)	D1 (mm)	Ho (mm)	Fig.
SP-BS-0900	340	300	180	Fig.a
SP-BS-0750-LI	340	300	350	
SP-BS-0750-LD				
SP-BS-0900-LI				
SP-BS-0900-LO				
SP-BS-1320	400	320	180	
SP-BS-1100-LI	400	320	380	
SP-BS-1100-LO				
SP-BS-1320-LI				
SP-BS-1320-LO				
SP-BS-1600	480	380	180	
SP-BS-1600-LI	480	380	400	

SP-BS-1600-LO				
SP-BS-2200	500	380	200	
SP-BS-2000-LI	500	380	400	
SP-BS-2000-LO				
SP-BS-2200-LI				
SP-BS-2200-LO	700	430	400	Fig.b
SP-BS-4000				
SP-BS-2500-LI				
SP-BS-2500-LO				
SP-BS-2800-LI				
SP-BS-2800-LO				
SP-BS-3150-LI	700	430	450	
SP-BS-3150-LO				
SP-BS-4000-LI				
SP-BS-4000-LO				

2.8 Outer size of keypad and its fixing box(unit:mm)

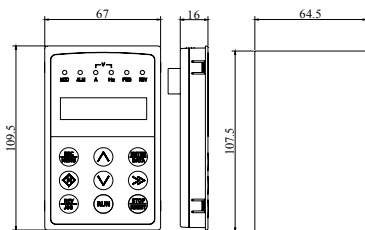

Fig.2-7 Mounting size of keypad

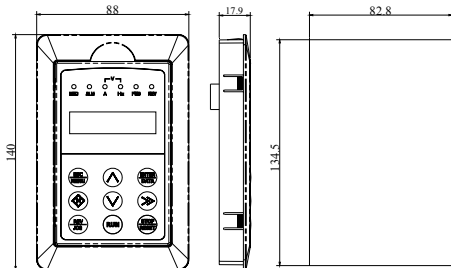

Fig.2-8 Hole size of keypad



Note

1. EN-LCD2 long-distance keypad outer lead, do not support keypad holder installed, only keypad installed support, mounting size refer to Fig.2-7.
2. Except EN-LCD2 long-distance keypad, when other keypad outer lead, user can adjust the hole size under actual situation on keypad or keypad holder; thickness of install board between 1.0~1.5mm is suggested.
3. When installed with keypad holder, it need to buy extra.

2.9 Product technic index and spec

Item		Item description	
Input	Rating volt., frequency	1 phase 220V Grade: 1 phase 220V, 50Hz/60Hz 3 phase 380V Grade: 3 phase 380V, 50Hz/60Hz	
	Allowed volt. range	1 phase 220V Grade: 200~260V 3 phase 380V Grade: 320~460V	
Output	Voltage	0~380V	
	Frequency	0~600Hz	
	Over loading capacity	G type: 150% of rated current for 1 minute; P type: 120% of rated current for 1 minute.	
Control Performance	Control mode	vector control, PG vector control, open-loop V/F control, torque control, PG torque control	
	Velocity control precision	±0.5% rated synchronous speed (vector control); ±0.1% rated synchronous speed (PG vector control); ±1% rated synchronous speed (V/F control);	
	Speed regulation range	1: 2000 (PG vector control) 1: 100 (vector control); 1: 50 (V/F control);	
	Start-up torque	1.0Hz: 150% rated torque (V/F control); 0.5Hz: 150% rated torque (vector control); 0Hz: 180% rated torque (PG vector control);	
	Speed fluctuation	±0.3% rated synchronous speed (vector control); ±0.1% rated synchronous speed (PG vector control);	
	Torque control precision	±10% rated torque (vector control, torque control); ±5% rated torque (PG vector control, PG torque control) .	
	Torque response	≤20ms (vector control); ≤10ms (PG vector control);	
	Frequency precision	Digital setting: max. frequency×±0.01%; Analog setting: max. frequency×±0.5%	
	Freq. resolution	Analog setting	0.1% of max. frequency
		Digital setting precision	0.01Hz
		Exterior impulse	0.1% of max. frequency
	Torque boost	Automatic torque boost; manual torque boost 0.1~12.0%	
	V/F curve(volt. Frequency characteristic)	Setting rated frequency at the range of 5~650Hz, by choosing constant torque, degressive torque 1, degressive torque 2, degressive torque 3, self-defined V/F total 5 kinds of curve.	
	Acceleration Deceleration curve	Two modes: straight line acceleration and deceleration; S curve acceleration and deceleration; 15 kinds of acceleration and deceleration time, time unit (0.01s, 0.1s, 1s) for option , max. time for 1000 minutes.	

2 Inverter type and specification

	brake	Power consumption brake	EN600 3 phase 15KW & under power range with inbuilt brake unit. only add brake resistor between (+) and PB. 18.5KW & up power range is possible to add brake unit between (+) and (-) outside; or extra connect brake unit with adding brake resistor between (+) and PB. EN500 series can connect brake unit between (+) and (-) outside.
		DC brake	Start, stop action for option, action frequency 0~15Hz, action current 0~100% of rated current, action time 0~30.0s
	jog	Jog frequency range: 0Hz~up limit frequency; jog acceleration and deceleration time 0.1~6000.0 seconds for setting.	
	Multi-section speed run	Realized by inbuilt PLC or control terminal; with 15 section speed, each section speed with separately acceleration and deceleration time; with inbuilt PLC can achieve reserve when power down.	
	Inbuilt PID controller	Convenient to make closed-loop control system	
	Automatic energy saving run	Optimize V/F curve automatically to achieve power saving run according to the load status.	
	Automatic voltage regulate(AVR)	Automatically keep output voltage constant, when the power grid voltage fluctuation	
	Automatic current limiting	Current limited automatically under run mode in avoid of inverter over-current frequently to trip.	
	carrier modulation	Modulate carrier wave automatically according to the load characteristic.	
	Speed tracking restart	Make rotating motor smoothly start without shocking	
Running function	running command specified channel	Keypad specified, control terminal specified, communication specified can switch through various means.	
	Running frequency specified channel	Main & auxiliary specified to a realize one main adjusting and one fine control. Digital specified, analog specified, pulse specified, pulse width specified, communication specified and others, which can be switched by many means at any time.	
	Binding function	Run command channel and frequency specified channel can bind together randomly and switch synchronously	
Input output characteristic	Digital input channel	Channel 8 for universal digital input, max. Frequency 1KHz, channel 1 can be used as pulse input channel, max. Input 50KHz, which can be expanded to channel 14 .	
	Analog input channel	Channel 2 for analog input channel, AI1 can choose 4~20mA or 0~10V output, AI2 is differential input channel, 4~20mA or -10~10V for option, which can be expanded to channel 4 analog input.	
	Pulse output channel	0.1 ~ 20KHz pulse square signal output to achieve setting frequency, output frequency and other physical quantity output.	
	Analog output channel	Channel 2 for analog signal output, AO1 can choose 4~20mA or 0~10V, AO2 can choose 4~20mA or 0~10V to achieve setting frequency, output frequency and other physical quantity output, which can be expanded to channel 4 analog output.	

Unique function	Rapid current limit	Limit inverter over current to the greatest point, and make it run more stably
	Monopulse control	Suitable for working site where need one button to control inverter start and stop, first press to start, then press to stop, and that cycle repeats. Its very simple and reliable.
	Fixed length control	Realize fixed length control
	Timing control	Timing control function: setting time range 0.1Min ~ 6500.0Min
	Virtual terminal	Five group virtual input & output IO can realize simply logical control
Keypad	Keypad display	The parameters as setting frequency, output frequency, output voltage, output current can be displayed
	Button Locked	Lock all or part of the buttons
Protection function		Motor power on Shot circuit test, input & output phase loss protection, over-current protection, over voltage protection, under voltage protection, over heat protection, overload protection, under load protection, relay absorption protection, terminal protection and no stop protection under power off.
Environment	Application site	Indoor, not bare to sunlight, no dust, no corrosive gas, no flammable gas, no vapor, no water drop or salt etc.
	Altitude	Under 1000 meter. (above 1000 meter require to reduce volume to use, output current reduce about 10% of rated currenvolt per 1000 meter high)
	Environment temperature	-10℃~+40℃ (environment temperature between 40℃~50℃, need to reduce volume or strengthen heat sink)
	Environment humidity	Smaller than 95%RH, no drop condenses
	Vibration	Smaller than 5.9 M/S ² (0.6g)
	Storage temperature	-40℃~+70℃
structure	Protection grade	IP20
	Cooling mode	Forced air cooling and natural
Installation mode		Wall hanging and cabinet installation



Note

To get a perfect usage performance of the inverter, Please check and select right type according to this chapter before wiring.



It is necessary to select right type, otherwise it may cause motor abnormal run or inverter damage.

3 Installation and wiring

3.1 Installation ambient

3.1.1 The demands for installation ambient

- (1) Installed in drafty indoor place, the ambient temperature should be within $-10^{\circ}\text{C}\sim 40^{\circ}\text{C}$, it needs external compulsory heat sink or reduce the volume if temperature is over than 40°C ; when temperature under -10°C , please preheat inverter first.
- (2) Avoid installing in places with direct sunlight, much dust, floating fiber and metal powder.
- (3) Don't install in place with corrosive, explosive gas.
- (4) The humidity should be smaller than 95%RH, without condensation water.
- (5) Installed in place of plane fixing vibration smaller than $5.9\text{m/s}^2(0.6\text{g})$.
- (6) Keep away from electromagnetic disturbance source and other electronic apparatus sensible to electromagnetic disturbance.

3.1.2 Installation direction and space

- (1) Normally the inverter should be mounted vertically, horizontal mounting will seriously affect heat dissipation and the inverter must be used in lower volume.
- (2) Demand for minimum mounting space and distance, please see Fig.3-1.
- (3) When installing multiple inverters up and down, leading divider must be applied between them, see fig. 3-2.

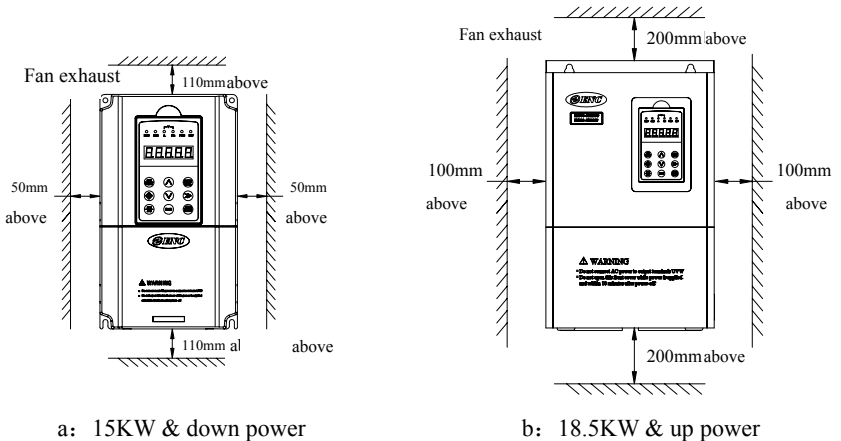

Fig.3-1 mounting space

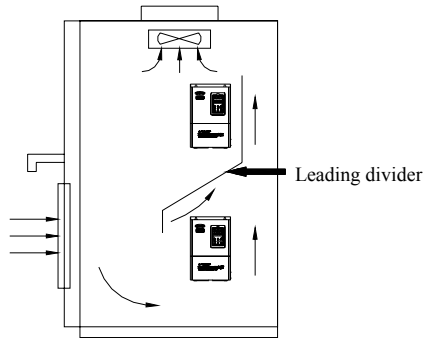

Fig.3-2 mounting of multiple inverters

3.2 Parts disassembly and installation

3.2.1 Keyboard disassembly and installation

(1) Disassembly

Let the forefinger press finger inlet on the keypad, depress fixing flexible plate on the top lightly, draw it outward, then you can disassemble the keypad.

(2) Assembly

First interface the fixed hook of on the bottom of keyboard with the keyboard installation claw of inverter, then press the fixed shrapnel on the top of keyboard to push it assemble well properly (keyboard assemble well when sounding of crisp), show as Fig.3-3.

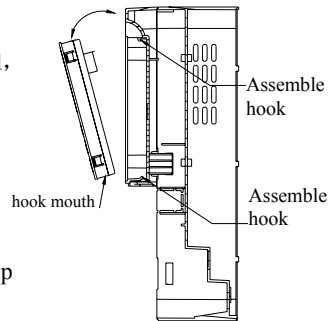

Fig.3-3 Keypad assembly

3.2.2 Cover disassembly and installation

3.2.2.1 Cover disassembly and installation

(1) Disassembly

Located the thumbs to the side bayonet, the ring fingers on the joint of the up and down cover, with thumbs press inside and pull upside at the same time until the bayonet open between cover and whole case, then pull back cover to make it off the inverter.

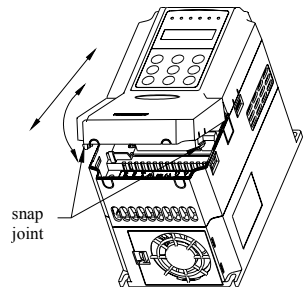

Fig.3-4 metal cover disassemble and assembly

(2) Assembly

- 1) tilt cover at 5~10 degree;
- 2) interface installation claw with hook on the top of inverter, press down heavily till cover bayonet enter into the holes of two side completely, show as Fig.3-4.

3.2.2.2 Metal cover disassembly and installation:

(1) Disassembly

First take off 2 screws at the side of the cover and move it a bit outward horizontally, then tilt it at 15 degree and draw it outward at the direction shown in right figure, now you can take the cover off.

(2) Assembly

First put down the cover in parallel with unit body and make it just locked at two sides of the inverter, secondly force it ahead and make fixing part on its top inserted into fixing slot of unit body, at last screw the cover and finish assembly for the cover.

As shown in Fig.3-5

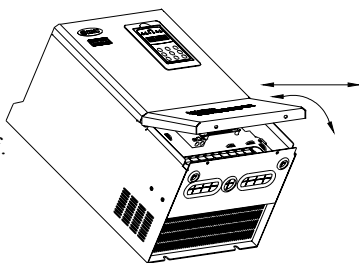

Fig.3-5 metal cover disassemble and assembly

3.3 Wiring notice points



- (1) Assure power be cut off completely for above 10 minutes before wiring, otherwise there is danger of getting electric shock.
- (2) Forbid connecting power wire to output U, V, W of the inverter.
- (3) If there is current leakage inside inverter, inverter and motor must be earth grounding for safety assurance, please refer to clause 8 in Chapter 3.4.1 for grounding wiring.
- (4) Before shipment compression resistance test of the inverter is Passed, so users should not conduct compression resistance test again.
- (5) Do not add absorbing capacitor or other resistance-capacitor absorbing device between inverter and motor; also do not add electromagnetic contact. If contactor and other switch component needed to add, please make sure inverter suspended without output, show as Fig.3-6
- (6) To provide inverter over-current protection in output side and convenient maintenance under power off, it should be connected to power source through air switch and contactor.
- (7) Control signal wire should select multicore stranded wire or shielding wire. One end of the shielding layer hang in the air, and the other end connect to inverter earth grounding terminal, connection wire shorter than 20m.



- (1) Before wiring, assure power supply is cut off completely for 10 minutes and all LED or LCD indicator light extinguished.
- (2) Before inverter internal wiring, confirm that DC volt. Between main loop end P+ and P- fall down to below DC36V.
- (3) Wiring can only be done by professional person trained and qualified.
- (4) Before power on, check if voltage grade of the inverter is in line with that of power supply volt., otherwise will cause personnel injured and device damaged.

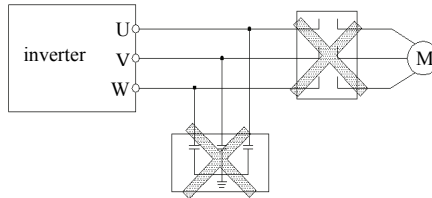

Fig.3-6 Forbid to use contactor and absorbing capacitor

3.4 Main loop terminal wiring

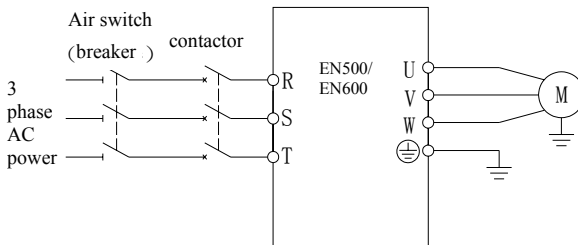

Fig.3-7 main loop simple wiring

To keep user power grid safety, please choose proper air switch, breaker, wiring at power input side, parameter recommended show as Table 3-1 (**Remark: wire must choose PVC insulation copper conductor**).

Table 3-1 parameter recommended for air switch (breaker), contactor and wire selection

Type	Air switch or breaker (A)	Contactor (A)	Input power wire mm ²	Output motor cable mm ²	Control signal wire mm ²
EN600-2S0004	6	9	0.75	0.75	0.5
EN600-2S0007	10	12	0.75	0.75	0.5
EN600-2S0015	16	18	1.5	1.5	0.5
EN600-2S0022	16	18	1.5	1.5	0.5
EN600-2S0037	20	25	2.5	2.5	0.75
EN600-4T0007G/0015P	6	9	0.75	0.75	0.5
EN600-4T0015G/0022P	10	12	0.75	0.75	0.5
EN600-4T0022G/0037P	16	18	1.5	1.5	0.5
EN600-4T0037G	16	18	1.5	1.5	0.5
EN600-4T0055P	20	25	2.5	2.5	0.75
EN600-4T0055G/0075P	20	25	2.5	2.5	0.75
EN600-4T0075G/0110P	25	25	4.0	4.0	0.75
EN600-4T0110G/0150P	32	32	6.0	6.0	0.75
EN600-4T0150G/0185P	40	40	6.0	6.0	0.75
EN600-4T0185G/0220P	50	50	10	10	1.0
EN600-4T0220G/0300P	50	50	10	10	1.0
EN600-4T0300G/0370P	63	63	16	16	1.0
EN600-4T0370G/0450P	80	80	25	25	1.0
EN600-4T0450G/0550P	100	115	35	35	1.0
EN600-4T0550G/0750P	125	125	50	50	1.0
EN500-4T0750G/0900P	250	160	70	70	1.5
EN500-4T0900G/1100P	250	160	95	95	1.5
EN500-4T1100G/1320P	350	350	120	120	1.5
EN500-4T1320G/1600P	400	400	120	120	1.5
EN500-4T1600G/2000P	500	500	150	150	1.5
EN500-4T2000G/2200P	630	630	185	185	1.5
EN500-4T2200G/2500P	700	700	240	240	1.5
EN500-4T2500G/2800P	800	800	120*2	120*2	1.5
EN500-4T2800G/3150P	800	800	120*2	120*2	1.5
EN500-4T3150G/3550P	1000	1000	150*2	150*2	1.5
EN500-4T3550G/3750P	1000	1000	185*2	185*2	1.5
EN500-4T3750G/4000P	1250	1250	240*2	240*2	1.5
EN500-4T4000G/4500P	1250	1250	240*2	240*2	1.5
EN500-4T4500G/5000P	1250	1250	270*2	270*2	1.5
EN500-4T5000G/5600P	1600	1600	270*2	270*2	1.5
EN500-4T5600G/6300P	1600	1600	300*2	300*2	1.5
EN500-4T6300G	2000	2000	300*2	300*2	1.5

3.4.1 Connection between inverter and fitting parts

(1) Breaking device like isolation

Switch must assemble between power source and inverter to keep persona safety under repairing and inverter requirement for compulsory power off.

(2) There must be over-current

Protection breaker or fuse in inverter power supply circuit to avoid failure expanding because of the second device failure.

(3) AC input reactor

When high harmonics between inverter and power supply is strong which cannot meet system requirement or input side power factor need to improve, ac input reactor can be added.

(4) Contactor is used to power supply only, do not use it to control inverter start and stop.

(5) Input side EMI filter

hoosing optionally EMI filter to restrain high frequency transduction interference and radio-frequency interference from inverter power line.

(6) Output side EMI filter

Choosing optionally EMI filter to restrain radio-frequency Interference and wire leakage current from inverter output side.

(7) AC output reactor

Installing AC output reactor is suggested to avoid motor insulation damage, oversize current leakage and inverter frequent protection when connecting wire between inverter and motor exceeds 50m.

(8) Safety earth ground wire

Inverter and motor must be earth ground connection, connection wire should select as shorter and thicker as above 3.5mm^2 multicore copper wire, and earth grounding resistance smaller than 10Ω .

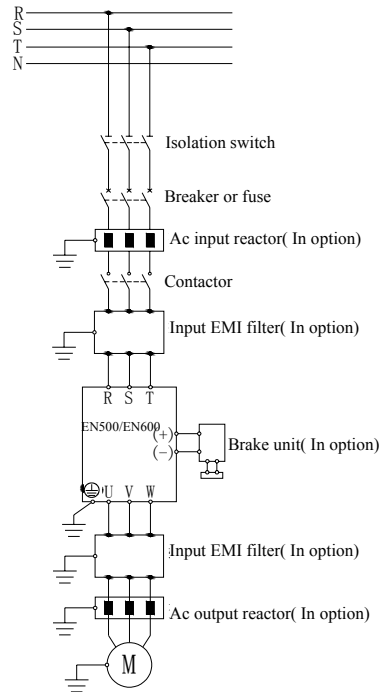
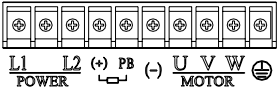



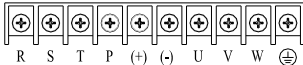

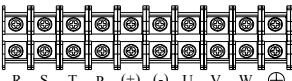
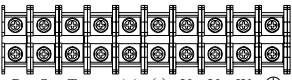



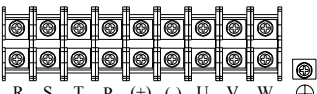

Fig.3-8 connection of inverter and fitting parts

3.4.2 Main loop terminal wiring

(1) Main loop input output terminal show as table 3-2, 3-3.

Table 3-2 EN600 main loop input output terminal description

Adapted type	Main loop terminal	Terminal name	Function description		
EN600-2S0004 ~ EN600-2S0037		L1、L2	1 phase AC input terminal, connect power source		
		(+)	DC volt. Positive terminal		
		PB	External connect to brake resistor reverse terminal		
		(-)	DC volt. Negative terminal		
		U、V、W	3 phase AC output terminal, connect to motor		
			Grounding terminal		
EN600-4T0007G/0015P ~ EN600-4T0150G/0185P		R、S、T	3 phase AC input terminal, connect power source		
		(+)	DC volt. Positive terminal		
		PB	External connect to brake resistor reverse terminal		
		(-)	DC volt. Negative terminal		
		U、V、W	3 phase AC output terminal, connect to motor		
			Grounding terminal		
EN600-4T0185G/0220P EN600-4T0220G/0300P	Terminal 1: 	R、S、T	3 phase AC input terminal, connect power source		
		P、(+)	External connect to DC reactor		
		(+)	DC volt. Positive terminal		
		PB	External connect to brake resistor reverse terminal		
		(-)	DC volt. Negative terminal		
	Terminal 2: 	(+)、(-)	External connect brake unit		
		U、V、W	3 phase AC output terminal, connect to motor		
			Grounding terminal		
		EN600-4T0300G/0370P EN600-4T0370G/0450P	Terminal 1: 	R、S、T	3 phase AC input terminal, connect power source
				P、(+)	External connect to DC reactor
PB	External connect to brake resistor reverse terminal				
Terminal 2: 	(+)		DC volt. Positive terminal		
	(-)		DC volt. Negative terminal		
	(+)、(-)		External connect brake unit		
U、V、W	3 phase AC output terminal, connect to motor				
	Grounding terminal				

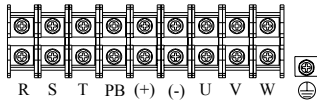
EN600-4T0450G/0550P EN600-4T0550G/0750P	Terminal 1: 	R、S、T	3 phase AC input terminal, connect power source	
		P、(+)	External connect to DC reactor	
		PB	External connect to brake resistor reverse terminal	
		(+)	DC volt. Positive terminal	
		(-)	DC volt. Negative terminal	
		(+)、(-)	External connect brake unit	
		U、V、W	3 phase AC output terminal, connect to motor	
			Grounding terminal	
		Terminal 2: 		

Note:

- ① EN600-4T0185G/0220P~EN600-4T0550G/0750P there are two kinds of sort order for main loop terminal, terminal 2 remove “P”, add “PB” terminal.
- ② EN600-4T0185G/0220P~EN600-4T0550G/0750P (terminal 1) short circuit diagram of copper bar assembly on main loop terminal

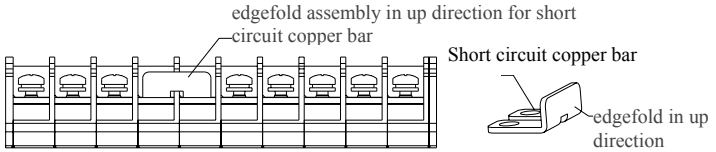
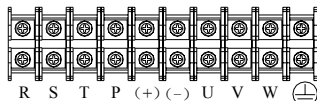

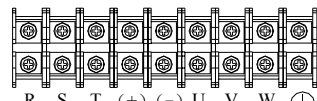



Table 3-3 EN500 main loop input output terminal description

Adapted type	Main loop terminal	Terminal name	Function description
EN500-4T0750G/0900P		R、S、T	3 phase AC input terminal, connect power source
		(+)	DC volt. Positive terminal
		(-)	DC volt. Negative terminal
		P、(+)	External connect to DC reactor
		(+)、(-)	External connect brake unit
		U、V、W	3 phase AC output terminal, connect to motor
			Grounding terminal
EN500-4T0900G/1100P ~ EN500-4T1320G/1600P		R、S、T	3 phase AC input terminal, connect power source
		(+)	DC volt. Positive terminal
		(-)	DC volt. Negative terminal
		(+)、(-)	External connect brake unit
		U、V、W	3 phase AC output terminal, connect to motor
			Grounding terminal

EN500-4T1600G/2000P ~ EN500-4T2200G/2500P		R, S, T 3 phase AC input terminal, connect power source (+) DC volt. Positive terminal (-) DC volt. Negative terminal (+) 、 (-) External connect brake unit U, V, W 3 phase AC output terminal, connect to motor Grounding terminal
EN500-4T2500G/2800P ~ EN500-4T4000G/4500P		R, S, T 3 phase AC input terminal, connect power source (+) DC volt. Positive terminal (-) DC volt. Negative terminal (+) 、 (-) External connect brake unit U, V, W 3 phase AC output terminal, connect to motor Grounding terminal
EN500-4T4500G/5000P ~ EN500-4T6300G		R, S, T 3 phase AC input terminal, connect power source (+) DC volt. Positive terminal (-) DC volt. Negative terminal (+) 、 (-) External connect brake unit U, V, W 3 phase AC output terminal, connect to motor Grounding terminal



1. The wiring of main loop must connect right according to the description above. Wrong wiring will cause device damage and personal injury.
2. Short circuit copper bar assembly for 18.5KW and up power (terminal 1) for EN600 must be edgefold in up direction, or it will cause device damage and personal injury in the reverse direction.

3.5 Basic running wiring diagram

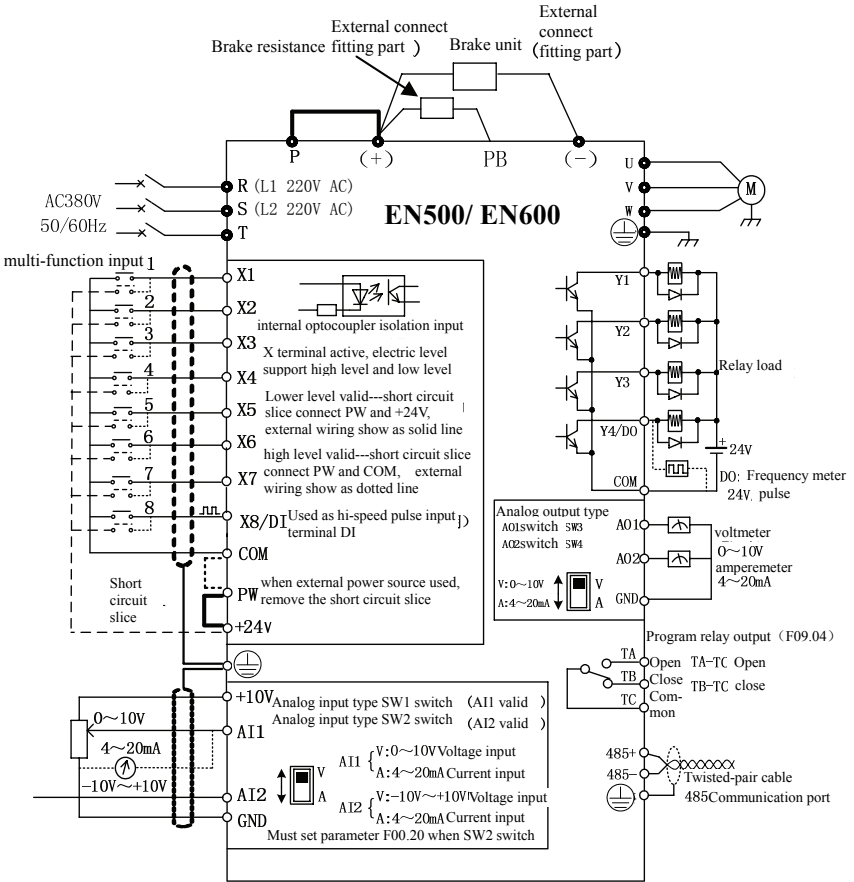

Fig.3-9 basic wiring diagram

Note: When connect to external DC reactor, it need to remove the short-circuit copper bar between P and (+) .

3.6 Control loop collocation and wiring

3.6.1 Relative location and function for control board terminal and slide switch:

Control board terminal and slide switch location show as Fig 3-10.

The terminal CN1 and CN7 are used by the manufacturers, CN2 is extended

interface, CN5 is for keypad, The CN3,CN4 and CN6 for users can be seen in table 3-4, The setting description and function of slide switch check table3-5. Please read the following descriptions carefully before using inverter.

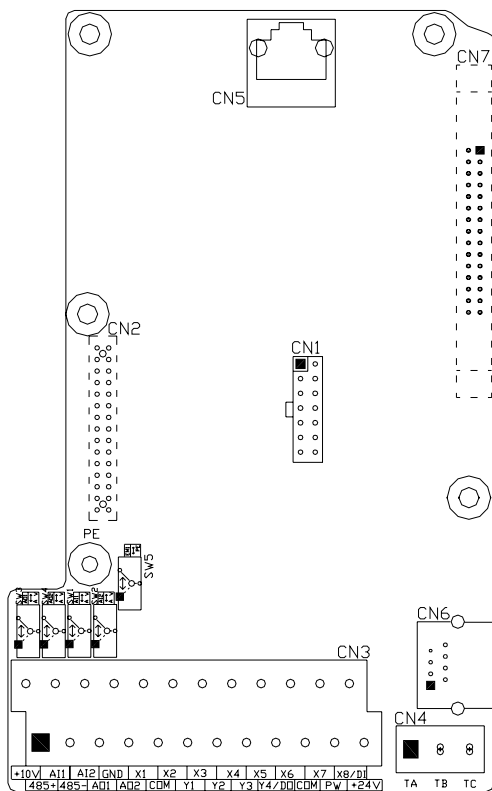









Fig.3-10 sketch map of CPU board

Table 3-4 function description of terminal provided for user

No.	Function	Description
CN3	Input and output control of external terminal	To use when inverter run under external terminal control , refer to 3.6.2
CN4	Signal output of relay	TA-TC is normal open contact; TB-TC is normal closed contact, refer to 3.6.2

CN6	CrystalRS485communication interface	To use when inverter through 485 communication can achieve cascade connection and other control, refer to 3.6.2
-----	-------------------------------------	-----------------------------------------------------------------------------------------------------------------

Table 3-5 Slide switch function description for users

No.	Function	Setting	Default value
SW1	AI1 Analog input signal selection	 V: F00.20 be XXX0 0~+10V voltage signal input  I: F00.20 be XXX1 4~20mA current signal input	F00.20 be 0000 0~+10V
SW2	AI2 Analog input signal selection	 V: F00.20 be XX0X, -10V~+10V voltage signal input  I: F00.20 be XX1X, 4~20mA current signal input	F00.20 be 0000 -10V~+10V
SW3	AO1 Analog output signal selection	 V: F00.21 be XX00 0~+10V voltage signal output	F00.21 be 0000 0~+10V
SW4	AO2 Analog output signal selection	 I: F00.21 be XX11 4~20mA current signal output	
SW5	EMI inhibition for selection terminal	 : earth grounding  : suspending	suspending



Note

(1) In the graphic of slide switch, black square means switch slidable location.

(2) Only when heavy interfering exist on working site, it's suggested to put EMI dial switch to earth grounding location, and  should connect to the earth.

3.6.2 Descriptions for control board terminal

(1) CN3 and CN4 terminal layout as following

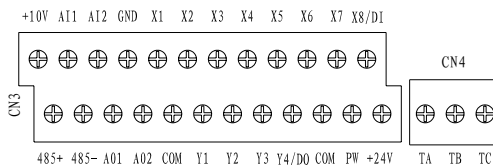

(2) CN3 and CN4 terminal function description show as Table 3-6

Table 3-6 function table for control board terminal

Type	Symbol	Description	Terminal Function and specification
Multifunction input terminal	X1	Multifunction input 1	Input voltage range: 15~30V; Opto coupler isolation, Compatible with bipolar input; Input impedance: 4.7KΩ max input frequency: 1KHz
	X2	Multifunction input 2	
	X3	Multifunction input 3	
	X4	Multifunction input 4	
	X5	Multifunction input 5	
	X6	Multifunction input 6	
	X7	Multifunction input 7	
	X8/DI	Multifunction input 8/ high-speed pulse input	Except for X1~X7 function, it can be used as hi-speed pulse input. Input impedance: 2.2KΩ max input frequency: 50KHz
Power source	+24V	+24V power source	Provide +24V power to external device (24±4V) Max output current: 200mA
	PW	External power source input	factory default connect to +24V; when use external signal to drive X terminal, it need to connect to external power source and cut off with +24V power terminal.
	+10V	+10V power source	Provide +10V power to external device (10±0.5V) Max output current:50mA
	COM	Common interface	Reference ground for digital signal and +24V power
	GND	Common interface	Reference ground for analog signal and +10V power
Analog input	AI1	Analog input 1	Input range: DC 0V~10V/4~20mA, selected by SW1 dial switch on control board. Input impedance: voltage input at 20KΩ; current input at 250Ω. resolution: 1/4000
	AI2	Analog input 2	Input range: DC-10V~10V/4~20mA, selected by the second figure of F00.20 and SW2 dial switch on control board. Input impedance: voltage input at 20KΩ; current input at 250Ω. resolution: 1/2000
Analog output	AO1	Analog output 1	Voltage or current output is selected by SW3 (AO1) and SW4 (AO2) dial switch on control board. Output voltage range: 0~10V Output current range: 4~20mA
	AO2	Analog output 2	
Multi-function output terminal	Y1	Open circuit collector output 1	Opto coupler isolation output, unipolar Open circuit collector output Max voltage output: 30V Max current output: 50mA
	Y2	Open circuit collector output 2	
	Y3	Open circuit collector output 3	

	Y4/DO	Open circuit collector output 4/ High-speed impulse output	Function code F00.22 to select terminal output mode When Open circuit collector output, with the same spec as terminal Y. When High-speed impulse output, the max frequency is 20KHz.
Relay output	TB—TC	Normal closed terminal	Contact capacity: AC250V/2A (cosφ=1) AC250V/1A (cosφ=0.4) DC30V/1A
	TA—TC	Normal open terminal	
Communication interface	485+	485 differential signal interface	485 differential signal positive terminal
	485-		485 differential signal negative terminal
Auxiliary interface	CN2	retain	
	CN6	StandardRS485 communication interface	Twisted-pair cable or shield wire to connect

(3) RS485 crystal outlet CN6 layout as following



RS485 terminal CN6 layout								
No.	1	2	3	4	5	6	7	8
Name	485+	485-	-	-	-	-	-	-

3.6.3 Analog input&output terminal wiring

(1) AI1 receive analog voltage or current signal single-ended input, switch through SW1, wire as below:

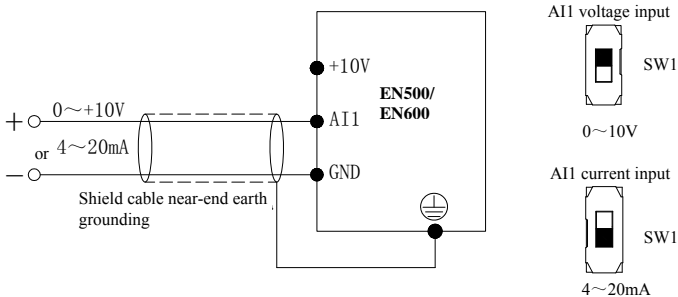

Fig.3-11 AI1 terminal wiring diagram

(2) AI2 receive analog voltage or current signal single-ended input, switch through SW2, and should match it with exact second figure of F00.20 setting, wire as below:

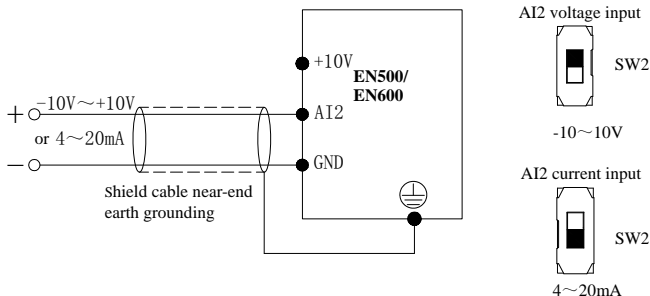

Fig.3-12 AI2 terminal wiring diagram

(3) AO1,AO2 terminal can connect to external analog meter, which can indicate several physical quantity, it can select analog voltage or current signal output, and switch through SW3 and SW4, wire as below:

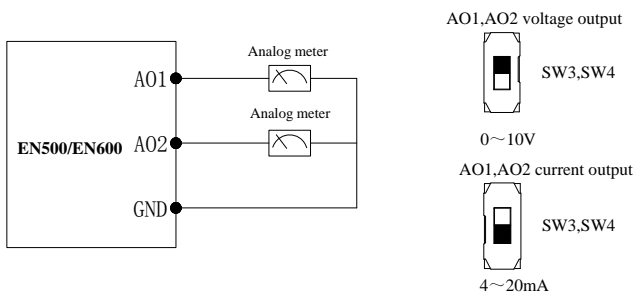

Fig.3-13 AO1,AO2 terminal wiring diagram



Note

- (1) Under analog input mode, filter capacitor or common mode choke can be installed between AI1 and GND or AI2 and GND.
- (2) Analog input and output signal can be interfered easily by ambient environment, it need use shield cable for connection and earth grounding well as short as possible.

3.6.4 Digital input terminal wiring

(1) To use inverter inbuilt +24V power supply, and NPN source type external controller connection mode.

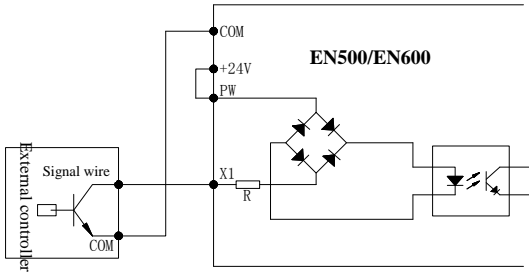

Fig.3-14 inbuilt 24V source type connection mode

(2) To use inverter inbuilt +24V power supply, and PNP drain type external controller connection mode.

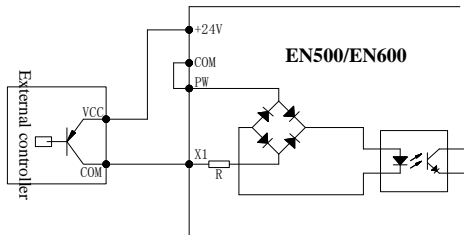

Fig.3-15 inbuilt 24V drain type connection mode

(3) To use external DC 15~30V power supply, and NPN source type external controller connection mode. (remove the short circuit slice between PW and +24V) .

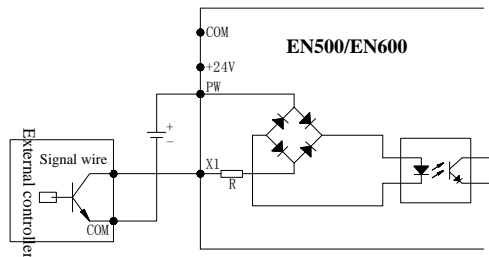

Fig.3-16 external power supply source type connection mode

(4) To use external DC 15~30V power supply, and PNP drain type external controller connection mode. (remove the short circuit slice between PW and +24V)

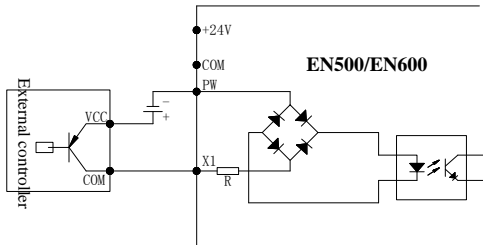

Fig.3-17 External power supply drain type connection mode

3.6.5 Communication terminal wiring

EN500/EN600 inverter provide RS485 serial communication interface to user. The following wire connection can make up of single-main single-sub control system or single-main multi-sub control system. To use host computer softwar(PC or PLC controller) can realize real time monitoring and operation to inverter, and to achieve complicated run control like long-distance control, high degree automation. It can also use a host inverter and the other slave inverter to make up of the cascade or synchronous control inverter network.

(1) Inverter RS485 interface and other device with RS485 interface wire connection show as following

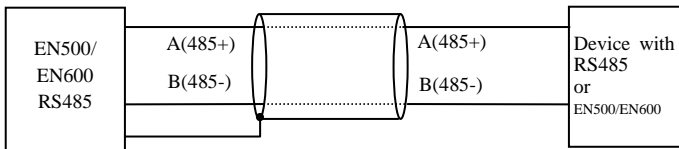

Fig.3-18 Communication terminal wiring

(2) Inverter RS485 interface and host computer (device with RS232 interface) connection:

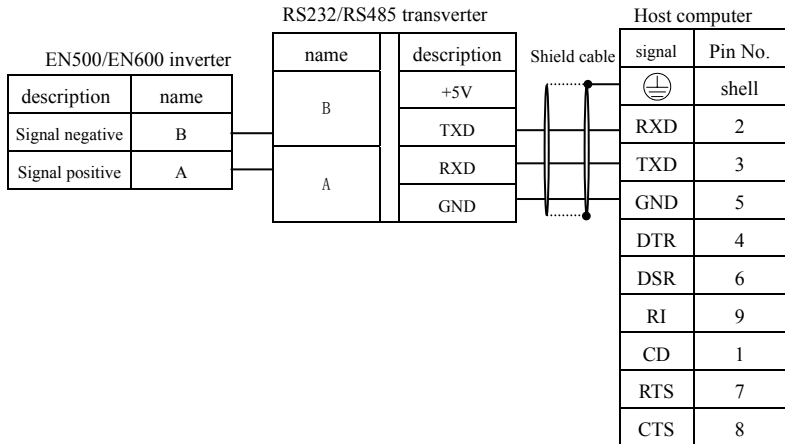

Fig.3-19 RS485 communication wiring

4 EMC (Electromagnetic compatibility) explanation

Because of inverter working principal resulting in electromagnetic noise, and to avoid or reduce inverter interference to ambient environment, this chapter introduce installation means to restrain interference from aspect of interference restrain, field wiring, system earth grounding, leakage current and power filter usage. Inverter will have good electromagnetic compatibility under general industrial environment, when user install the inverter according to this chapter.

4.1 Noise interference restraining

Inverter interference generating for run may have effect to nearby electronic device and the effect depend on the inverter installation surrounding electromagnetic environment and the restrain interference ability of the device.

4.1.1 Interference noise type

Because of inverter working principle, there are mainly 3 kinds of noise interference source:

- (1) circuit conduction interference;
- (2) space emission interference;
- (3) electromagnetic induction interference;

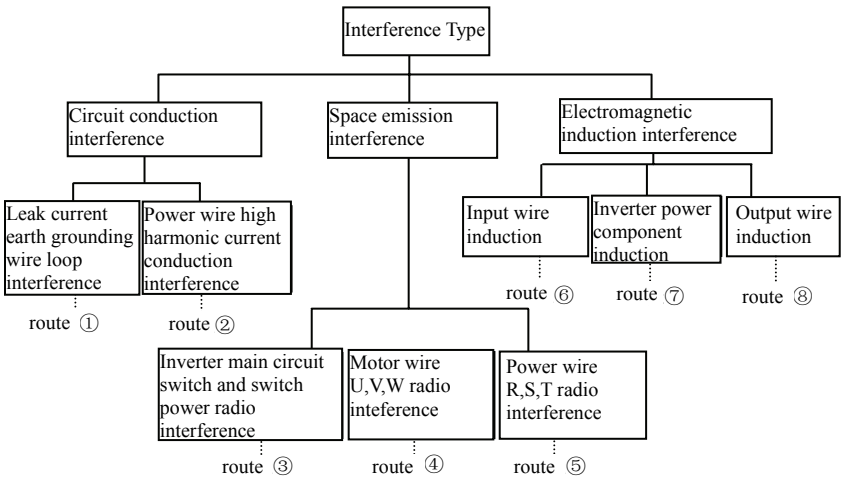

Fig.4-1 interference noise type

4.1.2 Basic countermeasure for restrain interference

Table 4-1 interference restrain countermeasure

Noise spread road	Countermeasure of weakening effect
①	Earth grounding cable of peripheral device and inverter wiring make up of the closed-loop and leakage current of inverter earth grounding cable will make device perform wrong action. It will decrease wrong action when device not connect to earth grounding.
②	When the power of peripheral device and inverter power belong to the same power source, high harmonic generating from inverter will transmit the voltage and current along with the power line which will interfere other devices within the same power source system. Take some restraining measures as below: install electromagnetic noise filter at inverter input end; use isolation transformer to isolate other devices; connect power end of peripheral device to remote power grid; add power ferrite filter magnetic ring to inverter R、S、T three phase wire to restrain high harmonic current conduction
③④⑤	<ul style="list-style-type: none"> ● Keep other sensitive devices and signal wire installed away from inverter. it should use shield wire and make the shield layer single end earth grounding. Besides keep distance from inverter and its input & output wire as possible as. When signal wire need to intersect with strong current cable, it should make them orthogonal crossing not parallel. ● Install high frequency noise filter (ferrite common code choke, also called magnetic ring) at the bottom end of the inverter input & output to restrain radio frequency interference of dynamic wire effectively. ● Motor cable should be placed in protective object with large thickness, such as placed in larger thickness(over 2mm) pipeline or buried in cemented tank. Putting dynamic wire in metal tube and connect to earth grounding with shield wire (motor cable use 4-core cable, one side is earthed through the inverter, the other side connected to motor casing).
⑥⑦⑧	To prevent wire parallel or bundled of strong and weak current, it should keep away from inverter assemble device, and wiring should away from inverter R,S,T,U,V,W equipower line. Devices with highfield and high magnetic field should notice the corresponding installation position of inverter and keep distance and orthogonal crossing.

4.2 Field wiring and earth grounding

- (1) inverter terminal motor connection wire (U,V,W terminal output wire) and inverter terminal power connection wire (R,S,T terminal input wire) should keep distance enough as possible as can.
- (2) U,V,W terminal 3 motor wires should be placed in metal tube or metal wiring tank as possible as.
- (3) Generally control signal wire should use shield cable, when shield layer connect to inverter (⊕) terminal, it should be the single end earth grounding which closed to inverter side.
- (4) Inverter (⊕) terminal earth grounding cable must directly connect to floor, it cannot connect to earth grounding through other device, and the location of earth grounding should close to inverter as possible as.
- (5) strong current cable(R,S,T,U,V,W) cannot parallel wiring closely with control signal wire, and bundled together is prohibited. It should keep distance from over 20~60 cm (relative to strong current size). When it's necessary to intersect, it should be orthogonal crossing, show as Fig.4-2.

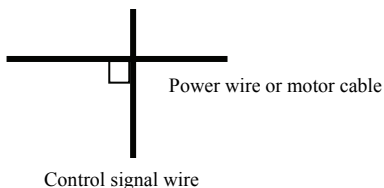

Fig.4-2 system wiring demand

- (6) earth grounding wire for strong current should separately connect to earth grounding with control signal and sensor earth grounding wire for weak current.
- (7) Forbid to connect inverter input terminal(R,S,T) to other devices.

4.3 Leak current and countermeasure

The leak current flows through inverter input and output terminal for wire capacitance and motor capacitance, and its size decided by the distributed capacitance and carrier frequency. There are two kinds of leak current: leak current to earth and wire-to-wire. Restraining methods as below:

- (1) diminish the cable length between inverter and motor.
- (2) install ferrite magnetic ring or output reactor at the inverter output terminal.



When reactor installed with rated voltage drop more 5% and long wiring to U, V, W terminal, it would reduce motor's voltage apparently. When motor run at full load, it is possible to flash motor, and it should be used by derating or boosting input and output voltage.

(3) as carrier frequency low, the motor noise would increase accordingly.

4.4 Installation demand for electromagnetic on-off electronic device

It should pay attention that surge absorber must be installed when electromagnetic on-off electronic device like relay, electromagnetic contactor and electromagnetic iron generating noise easily and largely installed near to inverter or in the same control cabinet, show as Fig. 4-3.

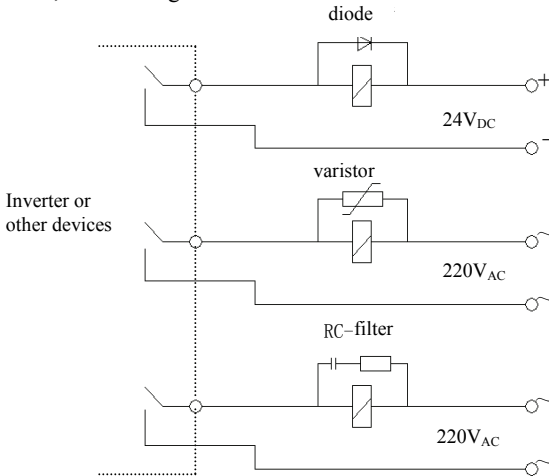

Fig.4-3 install demand for electromagnetic on-off device

4.5 Noise filter installation instructions

- (1) To use strictly as per the rated value; filter metal casing grounding must connect reliably to assemble cabinet metal grounding in large scale and it required good conductive continuity. Otherwise, it may cause electric shock and influence the EMC effect seriously.
- (2) Filter grounding terminal and inverter (⊕) terminal must connect to the same common earth grounding, otherwise it will influence the EMC effect seriously.
- (3) Filter installed as close as possible to inverter power input terminal.

5 Run and operation explanation for inverter

5.1 Run of inverter

5.1.1 Running order channels

There are 3 kinds of order channel for controlling run action of the inverter such as run, stop, jog etc.

0: keypad

Control by key , ,  on keypad (factory default).

1: Control terminal

Use control terminal FWD,REV,COM to make of double-line control, or use one terminal of X1~X8 and FWD or REV to make of three-line control.

2: Communication port

Control run and stop of the inverter through upper machine or other device which can communicate with the inverter.

Choose order channel by setting function code F01.15; and also can choose by multi-function input terminal (F08.18~F08.25 choose function 49,50,51,52,53).

Also can reach switch the command channel through multi-function key .



Please make switching debugging in advance when switch the order channel to check if it can fulfill system requirement, otherwise have danger of damaging device and injuring personal.

5.1.2 Frequency-provision channel

EN500/EN600 includes main frequency provision and assist frequency provision:

Main frequency provision:

0: keypad analog potentiometer provision;

1: AI1 analog setting;

2: AI2 analog setting;

3: terminal UP/DOWN adjustment provision;

4: communication provision(Modbus and external bus share a main frequency memory);

5: EAI1 analog setting(extend effective);

6: EAI2 analog setting(extend effective);

7: high speed pulse provision(X8 terminal need select the corresponding function);

8: terminal pulse width provision(X8 terminal need select the corresponding function);

9: terminal encoder provision(X1,X2 terminal connect to the encoder orthogonal input)

10~14: Reserved

Assist frequency provision:

0: keypad analog potentiometer provision;

1: AI1 analog setting;

2: AI2 analog setting;

3: terminal UP/DOWN adjustment provision;

4: communication provision(Modbus and external bus share a main frequency memory);

5: EA11 analog setting(extend effective);

6: EA12 analog setting(extend effective);

7: high speed pulse provision(X8 terminal need select the corresponding function);

8: terminal pulse width provision(X8 terminal need select the corresponding function);

9: terminal encoder provision(X1,X2 terminal connect to the encoder orthogonal input)

10~20: Reserved

5.1.3 Work state

Work state of EN500/EN600 includes of Waiting state, Running state and Parameter setting state.

Waiting state :

If there is no running command after the inverter electrified or after stop command during running state, the inverter enters into waiting state.

Running state:

The inverter enters into running state after receiving run command.

Parameter setting state:

After receiving the parameter identification command, enter the parameter setting state, after turning into the shutdown state.

5.1.4 Run mode

EN500/EN600 inverter have 6 kinds of run mode, following is in turn according to their priority, jog run → closed-loop run → PLC run → multi-section speed run → swing frequency run → common run. Shown as Fig.5-1.

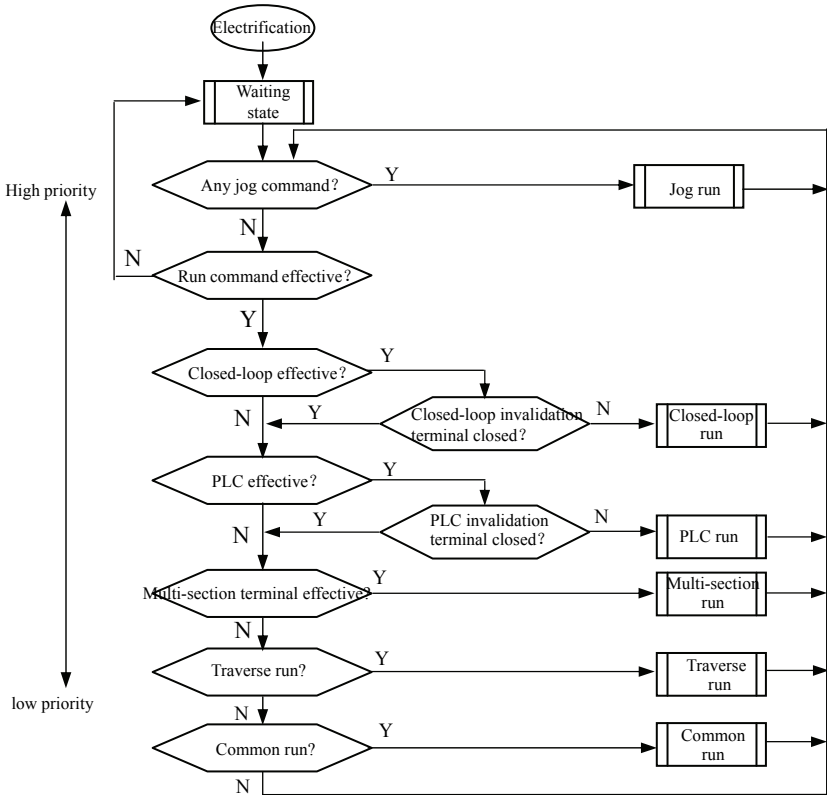



Fig.5-1 Run mode

0: Jog run

Upon receiving jog run command (for instance, press the  key on keypad) during waiting state, the inverter run at jog frequency (see function code F01.25~F01.29).

1: Closed-loop run

The inverter will come into closed-loop run mode when closed-loop run control

effective parameter is set($F11.00=1$ or $F12.00 \geq 1$). Namely carry on PID adjustment to specified value and feedback value(proportion integral differential calculation, see F11 group function code) and PID adjuster output is inverter output frequency. Can make closed-loop run mode ineffective and switch to lower level run mode by multi-function terminal (function 31).

2: PLC run

The inverter will enter into PLC run mode and run according to run mode preset(see F10 group function code description) through setting PLC function effective parameter($F10.00$ last bit $\neq 0$). Can make PLC run mode ineffective and switch to lower level run mode by multi-function terminal (function 36).

3: multi-section speed run

By nonzero combination of multi-function terminal(5,6,7,8,function), choose multi-section frequency 1~15($F10.31 \sim F10.45$) to run at multi-section speed.

4: swing frequency run

The inverter will enter into swing frequency run mode when swing frequency function effective parameter($F13.00=1$) is set. Set relevant swing frequency run special parameter according to textile swing frequency craft to realize swing frequency run.

5: common run

Common open loop run mode of general inverter.

In above 6 kinds of run mode except “jog run” the inverter can run according to kinds of frequency setting method.

5.2 Operation and use of key board

5.2.1 Keypad layout

The operating keyboard is the main unit of frequency inverter to accept commands, display parameters. Keyboard outline diagram shown in Figure 5-2.

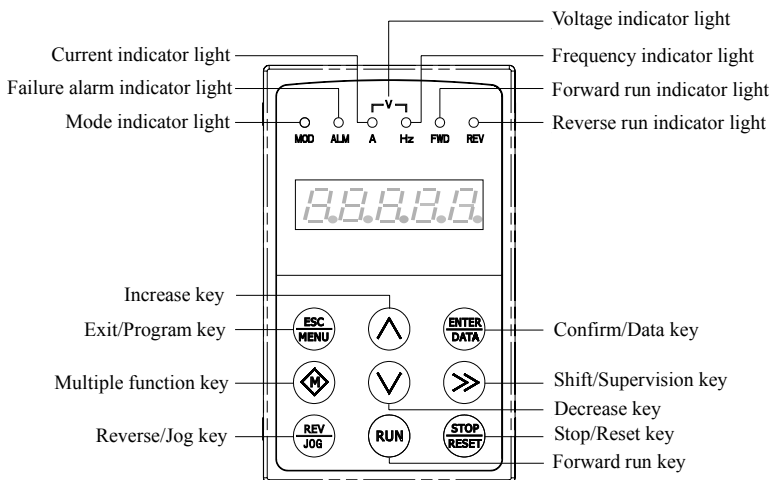





Fig.5-2 keypad layout sketch

5.2.2 Keypad function description

There are 9 key-presses on inverter keypad, and function definition of each key is as shown in table 5-1.

Table 5-1 keypad function table

Key	Name	Function description
	Program/Exit key	Enter into or exit programming state
	Shift/Supervision on key	Can choose modification digit of set data under editor state; can switch display status supervision parameter under other state
	Function/Data key	Enter into or exit programming state
	Rev/Jog key	Under keypad mode: to press this key can set reverse run or Jog run according to the 1 st bit of parameter F00.15
	Run key	Enter into forward run under keypad mode

	Stop/reset key	In common run status the inverter will be stopped according to set mode after pressing this key if run command channel is set as keypad stop effective mode. The inverter will be reset and resume normal stop status after pressing this key when the inverter is in malfunction status.
	Multi-function key	The specific function keys decided by tens digit of F00.15 see F00.15 parameter descriptions
	Increasing button	To increase data or function code (to press it continuously can improve increasing speed)
	Decreasing button	To decrease data or function code (to press it continuously can improve decreasing speed)

5.2.3 LED and indicator light

4 status indicator light: they are MOD(mode):ALM(alarm):FWD(forward run):REV(reverse run)from left to right on the LED: their respective indicating meaning is as shown in table 5-2.

Table 5-2 status indicator light description

Item		Function description		
Display function	Digital display	Display current run status parameter and set parameter		
	Status indicator light	A, Hz, V	Unit for relevant current digital displayed physical parameter(for current is A:for voltage is V:for frequency is Hz)	
		MOD	This indicator light is lit in non-supervision status and extinguished if no key pressed for a minute: then come back to supervision status	
		ALM	Alarm indicator light: indicate that the inverter is in over current or over voltage suppressing status or failure alarm status currently	
		FWD	Forward run indicator light, indicate that the inverter output forward phase order and the connected motor rotate in forward direction	The inverter work in DC brake status if FWD,REV indicator light is lit at the same time
		REV	Reverse run indicator light: indicate that the inverter output reverse phase order and the connected motor rotate in reverse direction	

5.2.4 Key board display status

EN500/EN600 keypad display status is classified as Waiting status parameter display; Function code parameter editing status display; Malfunction alarm status display; Run status parameter display; Alarm state display in total 5 kinds of status. LED indicator light will all be lit after the inverter electrified. Then enter into set frequency display. As shown in Fig.5-3 a

(1) Waiting parameter display status

The inverter is in waiting status and waiting status supervision parameter is displayed on keyboard: normally parameter F00.13 decide which status supervision parameter to be displayed. As shown in Fig.5-3 b, the indicator light shows the unit of the parameter.

To press (\gg) key, it can display different waiting status supervision parameter circularly: for detail please see C-00 to C-05 group supervision parameter details decide by F00.07~F00.12.

(2) Run parameter display status

The inverter enters into run status when receiving effective run command and normally parameter F00.13 decide which status supervision parameter to be displayed on the keypad. As shown in Fig.5-3 c, the indicator light shows the unit of the parameter.

To press (\gg) key can display run status supervision parameter circularly. For detail please see C-00 To C-05 group supervision parameter details decide by F00.01~F00.06 .

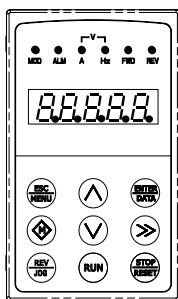

Fig.a Electrification, display 8.8.8.8.8.

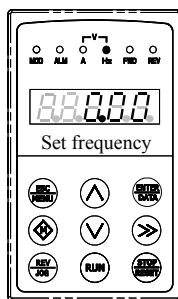

Fig.b waiting status, display waiting status parameter

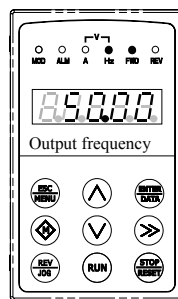

Fig.c run status: display run status parameter

Fig.5-3 inverter electrification: waiting: run status display

(3) Failure alarm display status

The inverter enters into failure alarm display status upon detecting failure signal and display failure code sparklingly(as shown in Fig.5-4);

To press (\gg) key can look over relative parameter after stopping running;

Can press (ESC/MENU) key to enter into program status to see about F26 group parameter if want to search

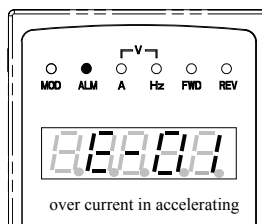

Fig.5-4





failure information.

Can carry on failure restoration by  key: control terminal or communication command on the keypad after troubleshooting. Keep displaying failure code if failure exist continuously.



For some serious failure, such as The earthing short circuit, Inverter modules protect, over current, over voltage etc., must not carry on failure reset forcibly to make the inverter run again without failure elimination confirmed. Otherwise have danger of damaging the inverter !

(4) Function code editing status

Under waiting, run or failure alarm status, press  key, can enter into editing status (If user password is set, can enter into editing status after inputting the password, see also F27.00 description and Fig.5-10), and editing status is displayed according to three classes menu mode, as shown in Fig. 5-5. To press  key can enter into one class by one class. Under function parameter display status, to press  key to carry on parameter storage operation; To press  key can only come back to upper class menu without storing modified parameter.

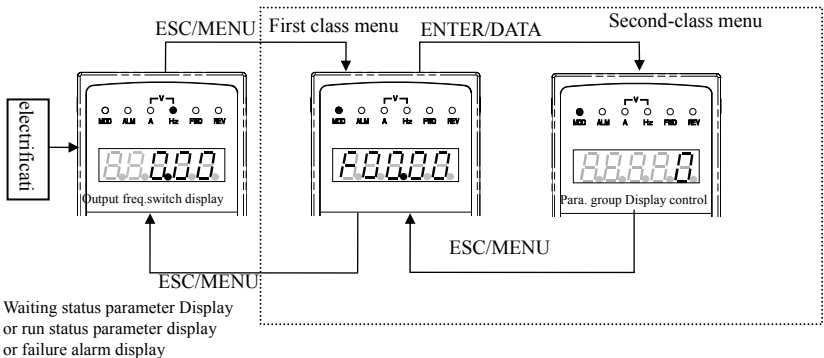

Fig.5-5 keypad display status switching

(5) Alarm state display

When under running and standby situation:
It means enter failure alarm display status upon detecting failure signal and display failure code sparklingly (Fig5-6) Inverter keeping running state But this alarm display can not be reset button eliminated: After only find the cause of the alarm: in order to eliminate

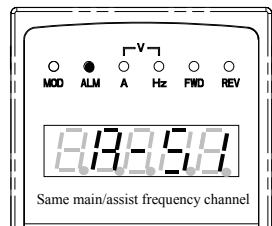

Fig.5-6

this factor Normal.

5.2.5 User Management Parameters

In order to facilitate the user parameter management: EN500/EN600 component model parameter menu for display management. The parameters do not need to be displayed can be shielded.

(1) Method parameter setting mode display.

By setting F00.00 = 0,1,2,3 respectively parameter mode is set: Basic menu mode: menu mode Intermediate: Advanced menu mode and user menu mode.

Basic menu	F00,F01,F02,F03,F26
Middle menu	F00,F01,F02,F03,F04,F05,F06,F07,F08,F09,F10,F11,F12,F13,F14,F15,F16,F18,F19,F26
Advance menu	F00,F01,F02,F03,F04,F05,F06,F07,F08,F09,F10,F11,F12,F13,F14,F15,F16,F17,F18,F19,F20,F21,F22,F23,F24,F25,F26,F27
User custom	F00.00 and F25 parameters group

5.2.6 Method for operating keypad

Can carry on various operation to the inverter through keypad, for example:

(1) Status parameter display switching:

After pressing key $\langle\langle\rangle\rangle$, display C group status supervision parameter; after displaying one supervision parameter code for 1 second will display this parameter value automatically. Press key $\langle\langle\text{ENTER DATA}\rangle\rangle$ will go back to supervision interface.

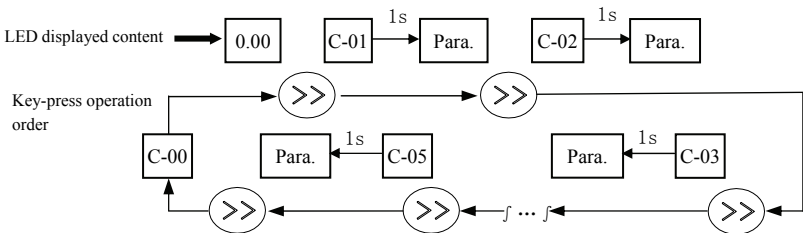

Fig.5-7 waiting status parameter display operating example

(2) Function code parameter setting

Take function code F01.01 modified from 5.00Hz to 6.00Hz as example.

Boldface in Fig.5-8 shows flickering digit.

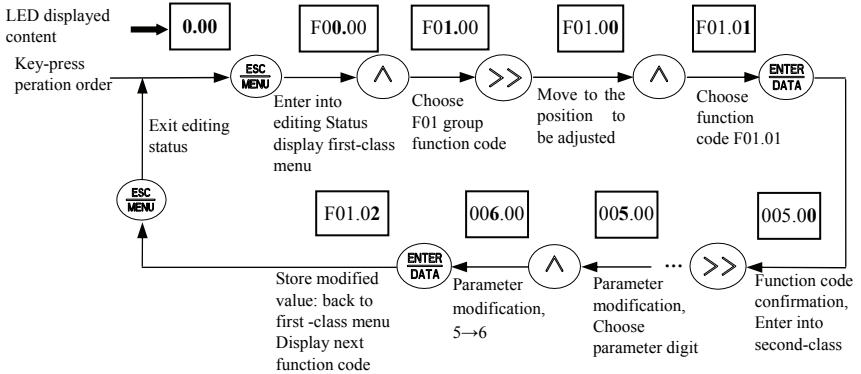

Fig.5-8 example for parameter setting and modification

Description: under second -class menu: if the parameter has no blinking digit, this function code can't be modified, possible reasons are as follows:

- 1> This function code shouldn't be modified: for example actual detected status parameter: run record parameter etc.;
- 2> This function code can't be modified under run status and can be changed after stopping running;
- 3> Parameter protected. All the function code can't be modified when function code F00.14=1 or 2, in order to avoid wrong operation. Need to set the function code F00.14 to 0 if you want to edit function code parameter.

(3) Specified frequency adjustment for common run

Take example modifying specified frequency from 50.00Hz to 40.00Hz at

F01.06=1, F01.03=0 during running for explanation.

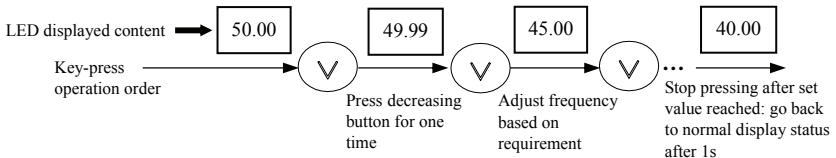

Fig.5-9 set frequency adjustment operation example

(4) Jog run operation

For example: keypad as current run command channel: jog run frequency 5Hz: waiting status.

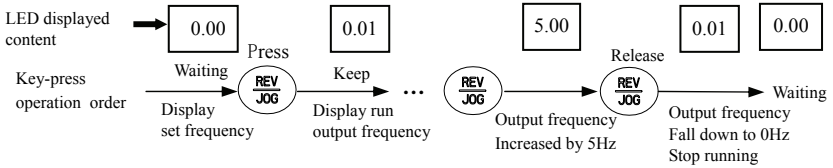

Fig.5-10 Jog run operating example

(5) Operation for entering to function code editing status after setting user password

For example :“User password” F27 is set to“12345”. Boldfaced digit in Fig.5-11 shows blinking bit.

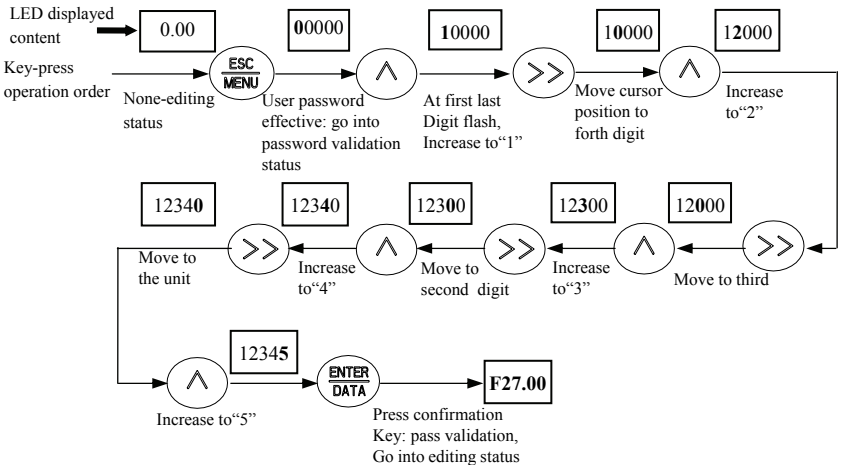

Fig.5-11 Inputting password to go into function code operation

(6) See about failure parameter under failure status:



If press >> key under failure status the user can quickly locate to the F26 group function code parameter. Press >> can quickly switch value between F26.04 ~ F26.10 parameters and fault alarm, easy to view the fault records.

(7) Keypad key-press locking operation

Under monitoring situation, To press ENTER DATA for 2s, the keyboard will display ‘LOCH1’, now the buttons on the keyboard are under locked. The detailed locked situation is decided by the value of hundred unit of F00.14.

(8) Keypad key-press unlocking operation

1) Under locked keypad situation, press M key for 2s to unlock the keypad.

2) Under locked keypad situation, if there is no  key, please press  for 2s to unlock the keypad.

5.3 Inverter electrification

5.3.1 Check before electrification

Please carry on wiring based on operation requirement provided in “inverter wiring” of this Service manual.

5.3.2 First electrification

Close input side AC power supply switch after correct wiring and power supply confirmed: electrify the inverter and keypad LED display “8.8.8.8.8”, contactor closed normally: LED displayed set frequency shows that electrification is finished. First electrification operation process is shown as Fig.5-12:

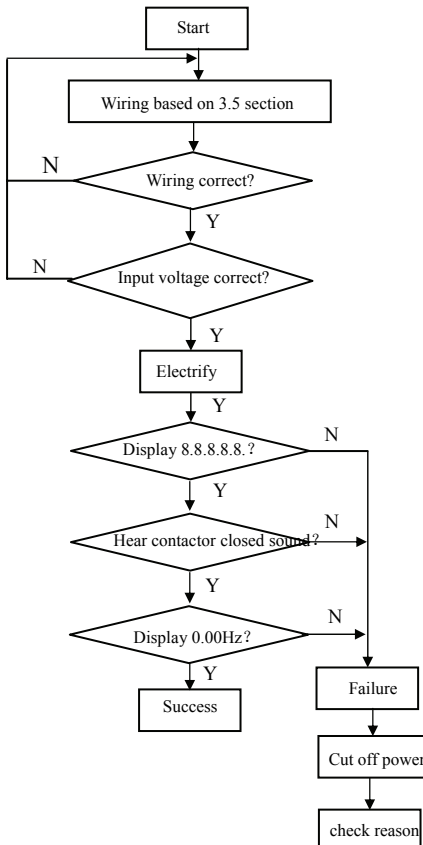

Fig.5-12 first electrification operation flow

6 Function parameter schedule graph

6.1 Symbol description









- × ---- parameter can't be changed in process of running
- ---- parameter can be changed in process of running
- * ---- read-only parameter, unmodifiable







6.2 Function parameter schedule graph

F00—System Parameter Group					
Function code	Name	Set range	Min. unit	Factory Default	Modification
F00.00	Parameter group display control	0: Basic list mode(only displayF00–F03 basic control parameter group and F26 fault record parameter group.) 1: Middle list mode. Display all parameter except for extension: virtual and reserve parameter group. 2: Senior list mode. All parameter display. 3: User list mode. Display parameter defined by user: and monitor parameter: F00.00 display all the time.	1	0	○
F00.01	C-00 display parameter selection when operation	0: main setup frequency (0.01Hz) 1: auxiliary setup frequency (0.01Hz) 2: setup frequency (0.01Hz) 3: output frequency (0.01Hz) 4: output current(0.1A) 5: output voltage(1V) 6: DC busbar voltage(0.1V) 7: motor speed(1 circle/min) 8: motor line velocity(1 circle/min) 9: inverter temperature(1℃) 10: run time already this time(0.1min) 11: current accumulate run time(1h) 12: current accumulate power-on time(1h) 13: inverter status 14: input terminal status 15: output terminal status 16: extension output terminal status 17: extension input terminal status 18: communication virtual input terminal status 19: internal virtual input node status 20: analog input AI1(after checkout) (0.01V / 0.01mA) 21: analog input AI2(after checkout) (0.01V / 0.01mA) 22: extension analog input EAI1(after checkout) (0.01V / 0.01mA) 23: extension analog input EAI2(after checkout) (0.01V / 0.01mA) 24: analog AO1 output(after checkout) (0.01V /0.01mA) 25: analog AO2 output(after checkout) (0.01V /0.01mA) 26: extension analog EAO1 output (0.01V /0.01mA)	1	51	○

		27: extension analog EAO2 output(0.01V /0.01mA) 28: external pulse input frequency(before checkout) (1Hz) 29: Reserved 30: process PID provide(0.01V) 31: process PID feedback(0.01V) 32: process PID deviation (0.01V) 33: process PID output (0.01Hz) 34: simple PLC current segment No. 35: external multi-speed current segment No. 36: constant pressure water supply provide pressure (0.001Mpa) 37: constant pressure water supply feedback pressure (0.001Mpa) 38: constant pressure water supply relay status 39: current length(1M) 40: accumulate length(1M) 41: current internal count value 42: current internal time value(0.1s) 43: run command setup channel(0: keyboard 1: terminal 2: communication) 44: main frequency provide channel 45: auxiliary frequency provide channel 46: rated current(0.1A) 47: rated voltage(1V) 48: rated power(0.1KW) 49: Reserved 50: Reserved 51: frequency after Acce/Dece(0.01Hz) 52: motor rotor frequency(0.01Hz) 53: current given torque (percentage relative to rated torque, with direction) 54: current output torque(percentage relative to rated torque, with direction) 55: torque current at present(0.1A) 56: flux current at present(0.1A) 57~65: Reserved			
F00.02	C-01 display parameter selection when operation	Same as above	1	2	○
F00.03	C-02 display parameter selection when operation	Same as above	1	4	○
F00.04	C-03 display parameter selection when operation	Same as above	1	5	○
F00.05	C-04 display parameter selection when operation	Same as above	1	6	○
F00.06	C-05 display parameter selection when operation	Same as above	1	9	○
F00.07	C-00 display parameter selection when stop	Same as above	1	2	○
F00.08	C-01 display parameter selection	Same as above	1	6	○

6 Function parameter schedule graph

	when stop				
F00.09	C-02 display parameter selection when stop	Same as above	1	48	○
F00.10	C-03 display parameter selection when stop	Same as above	1	14	○
F00.11	C-04 display parameter selection when stop	Same as above	1	20	○
F00.12	C-05 display parameter selection when stop	Same as above	1	9	○
F00.13	Power-on fault monitor parameter selection	0~5	1	0	○
F00.14	Parameter operation control	<p>Units digit: Parameter modification operations</p> <p>0: All parameters are allowed to be modified</p> <p>1: Except current parameter, all other parameters are not allowed to modify the</p> <p>2: Except F01.01, F01.04 and current parameter, all other parameters are not allowed to be modified</p> <p>Tens digit: Reset to factory defaults</p> <p>0: No action.</p> <p>1: All parameters return to default. (not include fault record parameter group (F26 group) parameter).</p> <p>2: Except for motor parameter: all parameters return to default. (not include F15 and F26 group parameter).</p> <p>3: Extension parameter return to default. (only F21~F24 group parameter return to default).</p> <p>4: Virtual parameter return to default. (only F20 group parameter return to default).</p> <p>5: Fault record return to default. (only fault record parameter group (F26 group) parameter return to default)</p> <p>Hundreds digit: Key operation</p> <p>0: All locked</p> <p>1: Except  button: the others locked</p> <p>2: Except  ,  ,  button: the others locked</p> <p>3: Except  ,  button: the others locked</p> <p>4: Except  ,  button: the others locked</p>	1	000	×

F00.15	Button function selection	Units digit: panel  button selection 0: Reversal command action button 1: Jog action button Tens digit:  multi-function button function selection 0: Invalid. 1: Jog run. 2: For/rev switching. 3: Free stop. 4: Switching to run command provide mode as the setup order of F00.16. 5: Forward/Reverse Torque Switching 6~9: Reserved Hundreds digit: terminal run command control 0: Keyboard  button invalid 1: Keyboard  button valid Thousands digit: communication run command control 0: Keyboard  button invalid 1: Keyboard  button valid	1	0001	○
F00.16	Multi-function key run command channel switching order selection	0: Keyboard control→ terminal control→ communication control 1: Keyboard control←→terminal control 2: Keyboard control←→communication control 3: Terminal control←→communication control	1	0	○
F00.17	Motor speed display coefficient	0.1~999.9%	0.1%	100.0%	○
F00.18	Line velocity display coefficient	0.1~999.9%	0.1%	1.0%	○
F00.19	Extended Port Parts set	0: Invalid 1: Reserved 2: Multi pump water supply card 3: Incremental PG encoder 4~10: Reserved	1	0	×
F00.20	Analog input terminal configuration	Units digit: AI1 configuration 0: 0~10V input 1: 4~20mA input Tens digit: AI2 configuration 0: -10~10V input 1: 4~20mA input Hundreds digit: EAI1 configuration 0: 0~10V input 1: -10~10V input 2: 4~20mA input Thousands digit: EAI2 configuration 0: 0~10V input 1: -10~10V input 2: 4~20mA input	1	0000	×
F00.21	Analog output terminal configuration	Units digit: AO1 configuration 0: 0~10V output 1: 4~20mA output Tens digit: AO2 configuration 0: 0~10V output 1: 4~20mA output Hundreds digit: EAO1 configuration	1	0000	×

6 Function parameter schedule graph

		0: 0~10V output 1: 4~20mA output Thousands digit: EAO2 configuration 0: 0~10V output 1: 4~20mA output			
F00.22	Y output terminal configuration	Units digit~ Hundreds digit: reserved Thousands digit: Y4 output configuration 0: Open collector output 1: DO output	1	0000	×
F00.23	G/P type setup	0: G type. 1: P type. Note: P type is only for V/F control	1	0	×
F00.24	Motor control mode	0: V/F control (object to torque control) 1: speed less sensor vector control 1 (compare to speed less sensor vector control 2, this control mode is more suitable for asynchronous motor ≤160KW, support speed and vector control) 2: speed sensor vector control (support asynchronous motor speed and torque control) 3: speed less sensor vector control 2 (only support asynchronous motor speed control, this control mode is more suitable for motor ≥185KW)	1	0	×
F00.25	Monitor parameter 2 selection	The same as parameter F00.01	1	2	○
F00.26	Busbar voltage adjustment coefficient	0.900~1.100	1	1.000	○
F00.27	Parameters copying and Language selection	Units digit: Language(only valid for LCD keypad) 0: Chinese 1: English 2: Reserved Tens digit: parameter upload and download (valid for LCD and digital potentiometer keypad) 0: Inaction 1: parameter upload 2: parameter download	1	00	×

F01—Basic Run Function Parameter Group

Function Code	Name	Set Range	Min. Unit	Factory Default	Modification
F01.00	Main frequency input channel selection	0: Operation keyboard digital setup 1: AI1 analog setup 2: AI2 analog setup 3: Terminal UP/DOWN adjusting setup 4: Communication provide. 5: EA11 analog setup. 6: EA12 analog setup 7: High speed pulse setup (X8 terminal need choose the suitable function) 8: Terminal pulse setup (X8 terminal need choose the suitable function) 9: Terminal encoder setup (X1:X2 connect the encoder punctuation input) 10~14: Reserved	1	0	○
F01.01	Main frequency	0.00Hz~upper limit frequency	0.01Hz	50.00Hz	○

	digital setup				
F01.02	Main frequency digital control	Only when parameter F01.00=0:3:4 valid. Units digit: power down reserve setup 0:Main frequency power down reserve. 1:Main frequency power down no reserve. Tens digit: halt reserve setup 0:Halt main frequency hold 1:Halt main frequency recovery F01.01	1	00	○
F01.03	Auxiliary frequency input channel select	0: Operation keyboard digital setup 1: AI1 analog setup 2: AI2 analog setup 3:Terminal UP/DOWN adjusting setup 4:Communication provide. 5:EAI1 analog setup. 6:EAI2 analog setup 7:High speed pulse setup(X8 terminal need choose the suitable function) 8:Terminal pulse setup(X8 terminal need choose the suitable function) 9:Terminal encoder setup(X1:X2 connect the encoder punctuation input) 10~20: Reserved	1	20	○
F01.04	Auxiliary frequency digital setup	0.00Hz~upper limit frequency	0.01Hz	0.00Hz	○
F01.05	Auxiliary frequency digital control	Units digit: power down reserve setup 0:Auxiliary frequency power down reserve. 1:Auxiliary frequency power down no reserve. Tens digit: halt reserve setup 0:Halt auxiliary frequency hold. 1:Halt auxiliary frequency recovery parameter F01.04	1	11	○
F01.06	Main and auxiliary provide calculating setup	0:Main frequency (complex frequency of current is main frequency). 1: Auxiliary frequency(complex frequency of current is auxiliary frequency.) 2: Plus(polarity oppose of complex and main frequency, complex frequency is zero). 3:Minus(polarity oppose of complex and auxiliary frequency, complex frequency is zero). 4:Multiplication(polarity opposed of main and auxiliary frequency: complex frequency is zero). 5:Max(the max frequency of main and auxiliary absolute value). 6:Min(the min frequency of main and auxiliary absolute value). 7:Selection no-zero value(auxiliary is not negative, main frequency prior; auxiliary is negative, complex frequency is zero).	1	0	○
F01.07	Auxiliary frequency provide coefficient	0.00~10.00	0.01	1.00	○
F01.08	Coefficient after complex of main and auxiliary frequency	0.00~10.00	0.01	1.00	○
F01.09	Auxiliary frequency range	0:Relative upper limit frequency. 1:Relative main frequency.	1	0	○

6 Function parameter schedule graph

	selection				
F01.10	Auxiliary frequency source scope	0.00~1.00	0.01	1.00	○
F01.11	upper limit frequency	Low limit frequency~600.00Hz	0.01Hz	50.00Hz	×
F01.12	Low limit frequency	0.00Hz~upper limit frequency	0.01Hz	0.40Hz	×
F01.13	Low limit frequency run mode	0:As low limit frequency run. 1:As setting frequency run. 2:As zero frequency run. 3:Sleep: PWM clocked at sleep mode.	1	2	×
F01.14	Sleep run hysteresis frequency	0.01Hz~upper limit frequency (This function can be used to finish the sleep mode function, realizing energy-saving operation process, and the hysteresis width can avoid inverter starting frequently in threshold)	0.01Hz	0.01Hz	○
F01.15	Run command channel selection	0:Operation keyboard run control. 1:Terminal run command control 2:Communication run command control.	1	0	○
F01.16	Run direction setup	Units digit: Keyboard command for/rev setup(only valid to keyboard inching command) 0:Forward 1:Reverse Tens digit: for/rev forbid(suitable for all command channel, not include inching function) 0:For/rev available. 1:Reverse not available(imposing on reverse, stop as the halt mode). 2:Forward not available(imposing on forward, stop as the halt mode)	1	00	○
F01.17	Acceleration time 1	1~60000(Acceleration time is interval accelerate from zero frequency to upper limit frequency)	1	Base on motor type	○
F01.18	Deceleration time 1	1~60000(deceleration time is the interval decelerate from upper limit frequency to zero frequency.)	1	Base on motor type	○
F01.19	Acc/Dece time unit	0: 0.01s 1: 0.1s 2: 1s	1	1	×
F01.20	Acc/Dece mode selection	0:Line acc/Dece mode. 1:S curve acc/Dece mode.	1	0	×
F01.21	S curve acceleration initiation segment time	10.0%~50.0% (Acceleration/deceleration time) S curve deceleration start time+ S curve deceleration raise time ≤90%)	0.1%	20.0%	○
F01.22	S curve acceleration up segment time	10.0%~70.0%(Acceleration/deceleration time) S curve acceleration start time+ S curve acceleration raise time ≤90%)	0.1%	60.0%	○
F01.23	S curve deceleration initiation segment time	10.0%~50.0%(Acceleration/deceleration time) S curve acceleration start time+ S curve acceleration raise time ≤90%)	0.1%	20.0%	○
F01.24	S curve deceleration up segment time	10.0%~70.0%(Acceleration/deceleration time) S curve acceleration start time+ S curve acceleration raise time ≤90%)	0.1%	60.0%	○
F01.25	Keyboard jog run	0.00Hz~upper limit frequency	0.01Hz	5.00Hz	○

	frequency				
F01.26	Terminal jog run frequency	0.00Hz~upper limit frequency	0.01Hz	5.00Hz	○
F01.27	Jog interval time	0.0~100.0s	0.1s	0.0s	○
F01.28	Jog acceleration time	0.1~6000.0s	0.1s	20.0s	○
F01.29	Jog deceleration time	0.1~6000.0s	0.1s	20.0s	○

F02—Start, stop, forward/reverse, brake function parameter group

Function Code	Name	Set Range	Min. Unit	Factory Default	Modification
F02.00	Start running mode	0: Start from starting frequency 1: First brake and then start from starting frequency 2: Start by revolving speed tracking	1	0	×
F02.01	Starting delay time	0.0~60.0s	0.1s	0.0s	×
F02.02	Starting frequency	0.0~10.00Hz	0.01Hz	0.00Hz	×
F02.03	Starting frequency duration time	0.0~60.0s	0.1s	0.0s	×
F02.04	DC braking current when starting	0.0~100.0% (G type inverter rated current)	0.1%	30.0%	×
F02.05	DC braking time when starting	0.0~30.0s	0.1s	0.0s	×
F02.06	Speed track starting frequency selection	0: Current setting frequency. 1: Running frequency before power down. 2: Speed track auxiliary starting frequency.	1	2	×
F02.07	Speed track auxiliary starting frequency	0.00Hz~upper limit frequency	0.01Hz	10.00Hz	×
F02.08	Speed track starting waiting time	0.00~10.00s	0.01s	0.10s	×
F02.09	Speed track current control coefficient	1~20	1	2	×
F02.10	Speed track searching speed time	0.1~30.0 (V/F control unit is 1 second; SVC control unit is 0.1 second)	0.1	4.0	×
F02.11	Stop mode	0: Deceleration stop. 1: Free stop 2: Deceleration + DC braking stop.	1	0	○
F02.12	Deceleration stop holding frequency	0.00~upper limit frequency (This parameter is only valid for stop mode 0.)	0.01Hz	0.00Hz	×
F02.13	Deceleration stop holding time	0.00~10.00s	0.01s	0.00s	×
F02.14	Stop DC braking starting frequency	0.00~15.00Hz	0.01Hz	0.00Hz	×
F02.15	stop DC braking waiting time	0.00~30.00s	0.01s	0.00s	×
F02.16	Stop DC braking current	0.0~100.0% (G type inverter rated current)	0.1%	0.0%	×
F02.17	Stop DC braking time	0.0~30.0s	0.1s	0.0s	×
F02.18	Stop auxiliary braking	0.0~100.0% (G type inverter rated current)	0.1%	0.0%	×

6 Function parameter schedule graph

	current				
F02.19	Stop auxiliary braking time	0.0~100.0s	0.1s	0.0s	×
F02.20	Forward/reverse dead zone time	0.0~3600.0s	0.1s	0.0s	×
F02.21	Forward/reverse switching mode	0: Over zero switchover 1: Over starting frequency switchover	1	0	×
F02.22	Energy consumption braking selection	0: No energy consumption braking 1: Energy consumption braking	1	0	○
F02.23	Energy consumption braking voltage	115.0~145.0% (rated busbar voltage)	0.1%	125.0%	○
F02.24	Energy consumption braking use rate	0.0~100.0%	0.1%	100.0%	○
F02.25	Encryption time	0~65535h	1	0	○
F02.26	Reserved				

F03—V/F control parameter group

Function Code	Name	Set Range	Min. Unit	Factory Default	Modification
F03.00	V/F curve set	0: Constant torque curve 1: Degression torque curve 1 (2.0 power) 2: Degression torque curve 1 (1.7 power) 3: Degression torque curve 3 (1.2 power) 4: User self-defined setting V/F curve (Confirmed by F03.04~F03.11)	1	0	×
F03.01	Torque boost mode	0: Manual boost. 1: Auto torque boost	1	0	○
F03.02	Torque boost	0.0~12.0%	0.1%	Base on motor type	○
F03.03	Torque boost cut-off frequency	0.0~100.0% (motor rated frequency)	0.1%	100.0%	○
F03.04	V/F frequency value 0	0.00~V/F frequency value 1	0.01Hz	10.00Hz	×
F03.05	V/F voltage value 0	0.00~V/F voltage value 1	0.01%	20.00%	×
F03.06	V/F frequency value 1	V/F frequency value 0~V/F frequency value 2	0.01Hz	20.00Hz	×
F03.07	V/F voltage value 1	V/F voltage value 0~V/F voltage value 2	0.01%	40.00%	×
F03.08	V/F frequency value 2	V/F frequency value 1~V/F frequency value 3	0.01Hz	25.00Hz	×
F03.09	V/F voltage value 2	V/F voltage value 1~V/F voltage value 3	0.01%	50.00%	×
F03.10	V/F frequency value 3	V/F frequency value 2~upper limit frequency	0.01Hz	40.00Hz	×
F03.11	V/F voltage value 3	V/F voltage value 2~100.00%(motor rated voltage)	0.01%	80.00%	×
F03.12	V/F oscillation suppression factor	0~255	1	10	○

F04—Auxiliary running parameter group

Function Code	Name	Set Range	Min. Unit	Factory Default	Modification
F04.00	Jump freq. 1	0.00Hz~upper limit frequency	0.01Hz	0.00Hz	×
F04.01	Jump freq. 1 range	0.00Hz~upper limit frequency	0.01Hz	0.00Hz	×
F04.02	Jump freq. 2	0.00Hz~upper limit frequency	0.01Hz	0.00Hz	×
F04.03	Jump freq. 2 range	0.00Hz~upper limit frequency	0.01Hz	0.00Hz	×
F04.04	Jump freq. 3	0.00Hz~upper limit frequency	0.01Hz	0.00Hz	×
F04.05	Jump freq. 3 range	0.00Hz~upper limit frequency	0.01Hz	0.00Hz	×

F04.06	Slip freq. gain	0.0~300.0%	0.1%	0.0%	×
F04.07	Slip compensation limit	0.0~250.0%	0.1%	100.0%	×
F04.08	Slip compensation time constant	0.1~25.0s	0.1s	2.0s	×
F04.09	Carrier freq.	0.5~16.0K	0.1K	Based on motor type	○
F04.10	PWM optimized adjustment	Units digit: Carrier freq. is adjusted automatically according to temperature 0: Banned. 1: Allowed. Tens digit: low speed carrier freq. limit mode 0: No limit. 1: Limit. Hundreds digit: carrier wave modulation system 0: 3 phase modulation. 1: 2 phase and 3 phase modulation. Thousands digit: Asynchronous modulation: synchronization mode (valid under V/F control) 0: Asynchronous modulation. 1: Synchronous modulation (under 85Hz: Asynchronous modulation).	1	0110	×
F04.11	AVR function	0: No action 1: Action all the time 2: No action only during deceleration	1	0	×
F04.12	Reserved				
F04.13	Automatic energy-saving operation	0: No action 1: Action	1	0	×
F04.14	Acceleration time 2 and 1 switchover frequency	0.00Hz~upper limit frequency	0.01Hz	0.00Hz	×
F04.15	Deceleration time 2 and 1 switchover frequency	0.00Hz~upper limit frequency	0.01Hz	0.00Hz	×
F04.16	Acceleration time 2	1~60000	1	200	○
F04.17	Deceleration time 2	1~60000	1	200	○
F04.18	Acceleration time 3	1~60000	1	200	○
F04.19	Deceleration time 3	1~60000	1	200	○
F04.20	Acceleration time 4	1~60000	1	200	○
F04.21	Deceleration time 4	1~60000	1	200	○
F04.22	Acceleration time 5	1~60000	1	200	○
F04.23	Deceleration time 5	1~60000	1	200	○
F04.24	Acceleration time 6	1~60000	1	200	○
F04.25	Deceleration time 6	1~60000	1	200	○
F04.26	Acceleration time 7	1~60000	1	200	○
F04.27	Deceleration time 7	1~60000	1	200	○
F04.28	Acceleration time 8	1~60000	1	200	○
F04.29	Deceleration time 8	1~60000	1	200	○
F04.30	Acceleration time 9	1~60000	1	200	○
F04.31	Deceleration time 9	1~60000	1	200	○
F04.32	Acceleration time 10	1~60000	1	200	○
F04.33	Deceleration time 10	1~60000	1	200	○
F04.34	Acceleration time 11	1~60000	1	200	○
F04.35	Deceleration time 11	1~60000	1	200	○
F04.36	Acceleration time 12	1~60000	1	200	○
F04.37	Deceleration time 12	1~60000	1	200	○
F04.38	Acceleration time 13	1~60000	1	200	○

6 Function parameter schedule graph

F04.39	Deceleration time 13	1~60000	1	200	○
F04.40	Acceleration time 14	1~60000	1	200	○
F04.41	Deceleration time 14	1~60000	1	200	○
F04.42	Acceleration time 15	1~60000	1	200	○
F04.43	Deceleration time 15	1~60000	1	200	○

F05—Terminal correlative function parameter group					
Function Code	Name	Set Range	Min. Unit	Factory Default	Modification
F05.00	protocol selection	0: Modbus protocol . 1: Reserved 2: Profibus protocol . (Extend effective) 3: CANlink protocol . (Extend effective) 4: CANopen protocol . (Extend effective) 5: Free protocol 1. (Can realize all the function parameter modification of EN500/EN600) 6: Free protocol 2. (Can realize part of the function parameter modification of EN500/EN600)	1	0	×
F05.01	Baud rate configuration	Units digit: Free protocol and Modbus Baud rate selection 0: 300BPS 1: 600BPS 2: 1200BPS 3: 2400BPS 4: 4800BPS 5: 9600BPS 6: 19200BPS 7: 38400BPS 8: 57600BPS Tens digit: Profibus-DP Baud rate selection 0: 115200BPS 1: 208300BPS 2: 256000BPS 3: 512000BPS Hundreds digit: CanLink and CANopen Baud rate selection 0: 20K 1: 50K 2: 100K 3: 125K 4: 250K 5: 500K 6: 1M	1	005	×
F05.02	Data format	Units digit: Free protocol and Modbus protocol data format 0: 1-8-1 format, no parity, RTU 1: 1-8-1 format, even parity, RTU 2: 1-8-1 format, odd parity, RTU 3: 1-7-1 format, no parity, ASCII 4: 1-7-1 format, even parity, ASCII 5: 1-7-1 format, odd parity, ASCII Tens digit: Profibus_DP protocol data format 0: PPO1 communication format 1: PPO2 communication format 2: PPO3 communication format 3: PPO5 communication format	1	000	×

		Hundreds digit: Modbus agreement or free protocol response selection 0: respond mainframe demand, and respond data package 1: respond mainframe demand and without response			
F05.03	Local address	0~247, this function code is used to identify inverter's address: among which 0 is broadcast address. When setting broadcast address: it can only receive and execute upper computer broadcast command: while cannot respond to upper computer.	1	1	×
F05.04	Communication overtime checkout time	0.0~1000.0s	0.1s	0.0s	○
F05.05	Communication error checkout time	0.0~1000.0s	0.1s	0.0s	○
F05.06	Local response delay time	0~200ms (Modbus effective)	1ms	5ms	○
F05.07	Main & sub inverter communication frequency setting percentage	0~500%	1%	100%	○
F05.08	communication virtual input terminal enabled	00~FFH Bit0: CX1 virtual input terminal enabled 0: forbidden 1: enabled Bit1: CX2 virtual input terminal enabled 0: forbidden 1: enabled Bit2: CX3 virtual input terminal enabled 0: forbidden 1: enabled Bit3: CX4 virtual input terminal enabled 0: forbidden 1: enabled Bit4: CX5 virtual input terminal enabled 0: forbidden 1: enabled Bit5: CX6 virtual input terminal enabled 0: forbidden 1: enabled Bit6: CX7 virtual input terminal enabled 0: forbidden 1: enabled Bit7: CX8 virtual input terminal enabled 0: forbidden 1: enabled	1	00H	○
F05.09	Communication virtual input terminal joining node	0: Independent node. 1: Terminal node.	1	0	○
F05.10	Communication virtual terminal CX1 function	0~90	1	0	○
F05.11	Communication virtual terminal CX2 function	0~90	1	0	○
F05.12	Communication virtual terminal CX3 function	0~90	1	0	○
F05.13	Communication virtual	0~90	1	0	○

6 Function parameter schedule graph

	terminal CX4 function				
F05.14	Communication virtual terminal CX5 function	0~90	1	0	○
F05.15	Communication virtual terminal CX6 function	0~90	1	0	○
F05.16	Communication virtual terminal CX7 function	0~90	1	0	○
F05.17	Communication virtual terminal CX8 function	0~90	1	0	○
F05.18	Input mapping application parameter 1	F00.00~F26.xx	0.01	25.00	○
F05.19	Input mapping application parameter 2	F00.00~F26.xx	0.01	25.00	○
F05.20	Input mapping application parameter 3	F00.00~F26.xx	0.01	25.00	○
F05.21	Input mapping application parameter 4	F00.00~F26.xx	0.01	25.00	○
F05.22	Input mapping application parameter 5	F00.00~F26.xx	0.01	25.00	○
F05.23	Input mapping application parameter 6	F00.00~F26.xx	0.01	25.00	○
F05.24	Input mapping application parameter 7	F00.00~F26.xx	0.01	25.00	○
F05.25	Input mapping application parameter 8	F00.00~F26.xx	0.01	25.00	○
F05.26	Input mapping application parameter 9	F00.00~F26.xx	0.01	25.00	○
F05.27	Input mapping application parameter 10	F00.00~F26.xx	0.01	25.00	○
F05.28	Reserved				
F05.29	Reserved				
F05.30	Reserved				
F05.31	Reserved				
F05.32	Reserved				
F05.33	Reserved				
F05.34	Reserved				
F05.35	Reserved				
F05.36	Reserved				
F05.37	Reserved				
F05.38	Reserved				
F05.39	Reserved				

F06—Setting curve parameter group

Function Code	Name	Set Range	Min. Unit	Factory Default	Modification
F06.00	Setting curve selection	Units digit: A11 curve selection 0: curve 1 1: curve 2 2: curve 3 Tens digit: A12 curve selection: The same as Units digit Hundred digit: rapid pulse curve selection: The same as Units digit Thousands digit: pulse width setting curve	1	0000	○

		selection: The same as Units digit			
F06.01	Curve 1 min. setting	0.0%~curve 1 inflexion setting	0.1%	0.0%	○
F06.02	Corresponding physical quantity of curve 1 min. setting	0.0~100.0%	0.1%	0.0%	○
F06.03	Curve 1 inflexion setting	Curve 1 min. setting ~ curve 1 Max. setting	0.1%	50.0%	○
F06.04	Corresponding physical quantity of curve 1 inflexion setting	0.0~100.0%	0.1%	50.0%	○
F06.05	Curve 1 Max. setting	Curve 1 inflexion setting ~ 100.0%, 100.0% is corresponding to 5V Input AD terminal	0.1%	100.0%	○
F06.06	Corresponding physical quantity of curve 1 Max. setting	0.0~100.0%	0.1%	100.0%	○
F06.07	Curve 2 min. setting	0.0%~curve 2 inflexion setting	0.1%	0.0%	○
F06.08	Corresponding physical quantity of curve 2 min. setting	0.0~100.0%	0.1%	0.0%	○
F06.09	Curve 2 inflexion setting	Curve 2 min. setting ~ curve 2 Max. setting	0.1%	50.0%	○
F06.10	Corresponding physical quantity of curve 2 inflexion setting	0.0~100.0%	0.1%	50.0%	○
F06.11	Curve 2 Max. setting	Curve 2 inflexion setting~100.0%	0.1%	100.0%	○
F06.12	Corresponding physical quantity of curve 2 Max. setting	0.0~100.0%	0.1%	100.0%	○
F06.13	Curve 3 min. setting	0.0%~curve 3 inflexion 1 setting	0.1%	0.0%	○
F06.14	Corresponding physical quantity of curve 3 min. setting	0.0~100.0%	0.1%	0.0%	○
F06.15	Curve 3 inflexion 1 setting	Curve 3 min. setting ~ curve 3 inflexion 2 setting	0.1%	30.0%	○
F06.16	Corresponding physical quantity of curve 3 inflexion 1 setting	0.0~100.0%	0.1%	30.0%	○
F06.17	Curve 3 inflexion 2 setting	Curve 3 inflexion 1 setting ~ curve 3 Max. setting	0.1%	60.0%	○
F06.18	Corresponding physical quantity of curve 3 inflexion 2 setting	0.0~100.0%	0.1%	60.0%	○
F06.19	Curve 3 Max. setting	Curve 3 inflexion 1 setting~100.0%	0.1%	100.0%	○
F06.20	Corresponding physical quantity of curve 3 Max. setting	0.0~100.0%	0.1%	100.0%	○
F06.21	Curve lower than min. input corresponding selection	Units digit: curve 1 setting 0: Corresponds to min. setting corresponding physical quantity. 1: 0.0% of the corresponding physical quantity. Tens digit: curve 2 setting Same as units digit. Hundreds digit: curve 3 setting Same as units digit. Thousands digit: extended curve 1 Same as units digit.	1	11111	○

6 Function parameter schedule graph

		Ten thousands digit: extended curve 2 Same as units digit.			
--	--	---------------------------------------------------------------	--	--	--

F07—Analog , Pulse input function parameter group					
Function Code	Name	Set Range	Min. Unit	Factory Default	Modification
F07.00	A11 input filter time	0.000~9.999s	0.001s	0.050s	×
F07.01	A11 setting gain	0.000~9.999	0.001	1.004	○
F07.02	A11 setting bias	0.0~100.0%	0.1%	0.5%	○
F07.03	A12 input filter time	0.000~9.999s	0.001	0.050s	×
F07.04	A12 setting gain	0.000~9.999	0.001	1.003	○
F07.05	A12 setting bias	0.0~100.0%	0.1%	0.1%	○
F07.06	Analog setting bias polarity	Units digit: A11 setting bias polarity 0: Positive polarity. 1: Negative polarity. Tens digit: A12 setting bias polarity 0: Positive polarity. 1: Negative polarity.	1	01	○
F07.07	Pulse input filter time	0.000~9.999s	0.001	0.000s	×
F07.08	Pulse input gain	0.000~9.999	0.001	1.000	○
F07.09	Pulse input Max. frequency	0.01~50.00KHz	0.01KHz	10.00KHz	○
F07.10	Pulse width input filter time	0.000~9.999s	0.001s	0.000s	×
F07.11	Pulse width input gain	0.000~9.999	0.001	1.000	○
F07.12	Pulse width input logic setting.	0:positive logic 1:negative logic	1	0	○
F07.13	Max pulse input width	0.1~999.9ms	0.1ms	100.0ms	○
F07.14	Reserved				
F07.15	Reserved				
F07.16	Reserved				
F07.17	Reserved				

F08—On-off input function parameter group					
Function Code	Name	Set Range	Min. Unit	Factory Default	Modification
F08.00	Input terminal positive and negative logic setting	0000~FFFF (include extend input terminal)	1	0000	○
F08.01	Input terminal filter time	0.000~1.000s (suitable for extend input terminal)	0.001s	0.010s	○
F08.02	X1 Input terminal closed time	0.00~99.99s	0.01s	0.00s	○
F08.03	X1 Input terminal opened time	0.00~99.99s	0.01s	0.00s	○
F08.04	X2 Input terminal closed time	0.00~99.99s	0.01s	0.00s	○
F08.05	X2 Input terminal opened time	0.00~99.99s	0.01s	0.00s	○
F08.06	X3 Input terminal closed time	0.00~99.99s	0.01s	0.00s	○
F08.07	X3 Input terminal opened time	0.00~99.99s	0.01s	0.00s	○

F08.08	X4 Input terminal closed time	0.00~99.99s	0.01s	0.00s	○
F08.09	X4 Input terminal opened time	0.00~99.99s	0.01s	0.00s	○
F08.10	X5 Input terminal closed time	0.00~99.99s	0.01s	0.00s	○
F08.11	X5 Input terminal opened time	0.00~99.99s	0.01s	0.00s	○
F08.12	X6 Input terminal closed time	0.00~99.99s	0.01s	0.00s	○
F08.13	X6 Input terminal opened time	0.00~99.99s	0.01s	0.00s	○
F08.14	X7 Input terminal closed time	0.00~99.99s	0.01s	0.00s	○
F08.15	X7 Input terminal opened time	0.00~99.99s	0.01s	0.00s	○
F08.16	X8 Input terminal closed time	0.00~99.99s	0.01s	0.00s	○
F08.17	X8 Input terminal opened time	0.00~99.99s	0.01s	0.00s	○
F08.18	Input terminal X1 function selection	0: Leave control terminal unused 1: Forward running FWD terminal 2: Reverse running REV terminal 3: External forward jogging control 4: External reverse jogging control 5: Multi-step speed control terminal 1 6: Multi-step speed control terminal 2 7: Multi-step speed control terminal 3 8: Multi-step speed control terminal 4 9: Acceleration/deceleration time selection terminal 1 10: Acceleration/deceleration time selection terminal 2 11: Acceleration/deceleration time selection terminal 3 12: Acceleration/deceleration time selection terminal 4 13: Main and auxiliary frequency operational rule selection terminal 1 14: Main and auxiliary frequency operational rule selection terminal 2 15: Main and auxiliary frequency operational rule selection terminal 3 16: Frequency ascending command (UP) 17: Frequency descending command (DOWN) 18: Frequency ascending/descending frequency resetting 19: Multi-step closed loop terminal 1 20: Multi-step closed loop terminal 2 21: Multi-step closed loop terminal 3 22: External equipment failure input 23: External interruption input 24: External resetting input 25: Free stop input 26: External stop instruction—Stop according to the stop mode 27: stop DC braking input command DB	1	1	×

		28: inverter running prohibited—Stop according to the stop mode 29: Acceleration/deceleration prohibited command 30: Three-wire running control 31: Process PID invalid 32: Process PID stop 33: Process PID integral holding 34: Process PID integral resetting 35: Process PID function negation(Closed loop adjustment feature negation) 36: simple PLC invalid 37: simple PLC halted 38: simple PLC stop state resetting 39: main frequency switchover to digit (keypad) 40: main frequency switchover to AI1 41: main frequency switchover to AI2 42: main frequency switchover to EAI1 43: main frequency switchover to EAI2 44: main frequency setting channel selection terminal 1 45: main frequency setting channel selection terminal 2 46: main frequency setting channel selection terminal 3 47: main frequency setting channel selection terminal 4 48: Auxiliary frequency reset 49: Command switchover to panel 50: Command switchover to terminal 51: Command switchover to communication 52: Running command Channel selection terminal 1 53: Running command Channel selection terminal 2 50: Forward prohibited command(Stop according to the stop mode: invalid for jogging command) 55: Reverse prohibited command (Stop according to the stop mode: invalid for jogging command) 56: Swinging frequency input 57: Resetting state of swinging frequency 58: Interior counter reset end 59: Interior counter input end 60: Internal timer resetting 61: Internal timer triggering 62: Length count input 63: Length reset 64: Reset this operation time 65: speed/torque control switching 66~90: Reserved 91: Pulse frequency input (X8 VALID) 92: Pulse width PWM INPUT (X8 VALID) 93~96: Reserved			
F08.19	Input terminal X2 function selection	Same as above	1	2	×
F08.20	Input terminal X3 function selection	Same as above	1	0	×
F08.21	Input terminal X4	Same as above	1	0	×

	function selection				
F08.22	Input terminal X5 function selection	Same as above	1	0	×
F08.23	Input terminal X6 function selection	Same as above	1	0	×
F08.24	Input terminal X7 function selection	Same as above	1	0	×
F08.25	Input terminal X8 function selection	Same as above	1	0	×
F08.26	FWD/REV operating mode selection	0: Two-wire control mode 1 1: Two-wire control mode 2 2: Two-wire control mode 3 (monopulse control mode) 3: Three-wire control mode 1 4: Three-wire control mode 2	1	0	×
F08.27	Set internal count value to setting	0~65535	1	0	○
F08.28	Specify internal count to setting	0~65535	1	0	○
F08.29	Internal timer timing setting	0.1~6000.0s	0.1s	60.0s	○
F08.30	Terminal pulse encoder frequency rate	0.01~10.00Hz (only be effective by given X1:X2 encoder)	0.01Hz	1.00Hz	○
F08.31	Reserved				

F09—On-off analog output function parameter group

Function Code	Name	Set Range	Min. Unit	Factory Default	Modification
F09.00	Open collector output terminal Y1 output setup	0:terminal unused 1:operation(RUN) 2:CW run 3:CCW run 4:DC brake 5:run prepare finish(busbar voltage normal, fault free, no run forbid, receipt of run command's status) 6:stop command indication 7:no current detected 8:overcurrent detected 9:current1 arrival 10:current2 arrival 11:no frequency output 12:frequency arrival signal(FAR) 13:frequency level detect signal 1(FDT1) 14:frequency level detect signal 2(FDT2) 15:output frequency arrival upper limit(FHL) 16:output frequency arrival low limit(FLL) 17:frequency 1 arrival output 18:frequency 2 arrival output 19:overload pre-alarm signal(OL) 20:undervoltage lockout stop (LU) 21:external fault stop(EXT) 22:fault 23:alarm 24:simple PLC operation 25:simple PLC section operation finish 26:simple PLC circle operation finish	1	0	×

	<p>27:simple PLC operation stop 28:traverse frequency high and low limit 29:setup length arrival 30:internal counter final value arrival 31:internal counter designated value arrival 32:internal timer arrival---output 0.5s valid signal on arrival 33:operation stop time finish 34:operation arrival time finish 35:setup run time arrival 36:setup power on time arrival 37:1st pump variable frequency 38:1st pump power frequency 39:2nd pump variable frequency 40:2nd pump power frequency 41:communication provision 42~60:reserve0:terminal unused 1:operation(RUN) 2:CW run 3:CCW run 4:DC brake 5:run prepare finish(busbar voltage normal, fault free, no run forbid, receipt of run command's status) 6:stop command indication 7:no current detected 8:overcurrent detected 9:current1 arrival 10:current2 arrival 11:no frequency output 12:frequency arrival signal(FAR) 13:frequency level detect signal 1(FDT1) 14:frequency level detect signal 2(FDT2) 15:output frequency arrival upper limit(FHL) 16:output frequency arrival low limit(FLL) 17:frequency 1 arrival output 18:frequency 2 arrival output 19:overload pre-alarm signal(OL) 20:undervoltage lockout stop (LU) 21:external fault stop(EXT) 22:fault 23:alarm 24:simple PLC operation 25:simple PLC section operation finish 26:simple PLC circle operation finish 27:simple PLC operation stop 28:traverse frequency high and low limit 29:setup length arrival 30:internal counter final value arrival 31:internal counter designated value arrival 32:internal timer arrival---output 0.5s valid signal on arrival 33:operation stop time finish 34:operation arrival time finish 35:setup run time arrival 36:setup power on time arrival 37:1st pump variable frequency 38:1st pump power frequency 39:2nd pump variable frequency</p>			
--	--------------------------------------------------------------------------------------------------------------------------------------------------------------------------------------------------------------------------------------------------------------------------------------------------------------------------------------------------------------------------------------------------------------------------------------------------------------------------------------------------------------------------------------------------------------------------------------------------------------------------------------------------------------------------------------------------------------------------------------------------------------------------------------------------------------------------------------------------------------------------------------------------------------------------------------------------------------------------------------------------------------------------------------------------------------------------------------------------------------------------------------------------------------------------------------------------------------------------------------------------------------------------------------------------------------------------------------------------------------------------------------------------------------------------------------------------------------------------------------------------------------------------------------------------------------------------------------------------------------------------------------------------------------------------------------------------------------------------------------------------------------------------------------------------------------------------------------------------------------------------------------------------------------------------------------------------------------------------------------------------------------------------------------------------------------------------------------------------------------------------------------------------------------------------------------------	--	--	--

		40:2 nd pump power frequency 41:communication provision 42: torque control speed limiting 43~60: Reserved			
F09.01	Open collector output terminal Y2 output setup	Same as above	1	0	×
F09.02	Open collector output terminal Y3 output setup	Same as above	1	0	×
F09.03	Open collector output terminal Y4 output setup	Same as above	1	0	×
F09.04	Programmable relay output setting	Same as above	1	22	×
F09.05	Detection amplitude of Frequency arrival(FAR)	0.00~50.00Hz	0.01Hz	5.00Hz	○
F09.06	FDT1(frequency level)level	0.00Hz~upper limit frequency	0.01Hz	10.00Hz	○
F09.07	FDT1 lag	0.00~50.00Hz	0.01Hz	1.00Hz	○
F09.08	FDT2(frequency level)level	0.00Hz~upper limit frequency	0.01Hz	10.00Hz	○
F09.09	FDT2 lag	0.00~50.00Hz	0.01Hz	1.00Hz	○
F09.10	Zero frequency signal detection value	0.00Hz~upper limit frequency	0.01Hz	0.00Hz	○
F09.11	Zero frequency backlash	0.00Hz~upper limit frequency	0.01Hz	0.00Hz	○
F09.12	Zero-current detection amplitude	0.0~50.0%	0.1%	0.0%	○
F09.13	Zero-current detection time	0.00~60.00s	0.01s	0.1s	○
F09.14	Over-current detection value	0.0~250.0%	0.1%	160.0%	○
F09.15	Over-current detection time	0.00~60.00s	0.01s	0.00s	○
F09.16	Current 1 arrival detection value	0.0~250.0%	0.1%	100.0%	○
F09.17	Current 1 width	0.0~100.0%	0.1%	0.0%	○
F09.18	Current 2 arriving the detection value	0.0~250.0%	0.1%	100.0%	○
F09.19	Current 2 width	0.0~100.0%	0.1%	0.0%	○
F09.20	Frequency 1 arriving the detection value	0.00Hz~upper limit frequency	0.01Hz	50.00Hz	○
F09.21	Frequency 1 arriving the detection width	0.00Hz~upper limit frequency	0.01Hz	0.00Hz	○
F09.22	Frequency 2 arriving the detection value	0.00Hz~upper limit frequency	0.01Hz	50.00Hz	○
F09.23	Frequency 2 arriving the detection width	0.00Hz~upper limit frequency	0.01Hz	0.00Hz	○
F09.24	positive and negative logic setup of Output terminal	0000~FFFF (extension valid)	1	0000	○
F09.25	Y1 output closed delay time	0.000~50.000s	0.001s	0.000s	○
F09.26	Y1 output disconnected delay time	0.000~50.000s	0.001s	0.000s	○

6 Function parameter schedule graph

F09.27	Y2 output closed delay time	0.000~50.000s	0.001s	0.000s	○
F09.28	Y2 output disconnected delay time	0.000~50.000s	0.001s	0.000s	○
F09.29	Y3 output closed delay time	0.000~50.000s	0.001s	0.000s	○
F09.30	Y3 output disconnected delay time	0.000~50.000s	0.001s	0.000s	○
F09.31	Y4 output closed delay time	0.000~50.000s	0.001s	0.000s	○
F09.32	Y4 output disconnected delay time	0.000~50.000s	0.001s	0.000s	○
F09.33	Relay output closed delay time	0.000~50.000s	0.001s	0.000s	○
F09.34	Relay output disconnected delay time	0.000~50.000s	0.001s	0.000s	○
F09.35	Analog output(AO1) selection	0:output frequency before slip compensation (0.00Hz~upper limit frequency) 1:output frequency after slip Compensation (0.00Hz~upper limit frequency) 2:Setup frequency(0.00Hz~upper limit frequency) 3:main setting frequency(0.00Hz~upper limit frequency) 4:auxiliary setting frequency(0.00Hz~upper limit frequency) 5:output current 1(0~2×inverter rated current) 6:output current 2(0~3×motor rated current) 7:output voltage(0~1.2×load motor rated voltage) 8:busbar voltage(0~1.5×rated busbar voltage) 9:motor speed(0~3 rated speed) 10:PID provision(0.00~10.00V) 11:PID feedback(0.00~10.00V) 12:A11(0.00~10.00V or 4~20mA) 13:A12(-10.00~10.00V or 4~20mA) 14:communication provision 15: motor rotor revolving speed (0.00Hz~upper limit frequency) 16: present setting torque (0~2 times rated torque) 17: present output torque (0~2 times rated torque) 18: present torque current (0~2 times motor rated current) 19: present flux current (0~1 times motor rated flux current) 20~25: Reserved	1	0	○
F09.36	Analog output(AO2) selection	Same as above	1	0	○
F09.37	DO function selection(with Y4 reuse)	Same as above	1	0	○
F09.38	Reserved				
F09.39	Analog output(AO1) filter time	0.0~20.0s	0.1s	0.0s	○
F09.40	Analog output(AO1) gain	0.00~2.00	0.01	1.00	○

F09.41	Analog output(AO1) bias	0.0~100.0%	0.1%	0.0%	○
F09.42	Analog output(AO2) filter time	0.0~20.0s	0.1s	0.0s	○
F09.43	Analog output(AO2) gain	0.00~2.00	0.01	1.00	○
F09.44	Analog output(AO2) bias	0.0~100.0% (AO2 output terminal with Y3 reuse)	0.1%	0.0%	○
F09.45	DO filter time	0.0~20.0s	0.1s	0.0s	○
F09.46	DO output gain	0.00~2.00	0.01	1.00	○
F09.47	DO maximum pulse output frequency	0.1~20.0KHz	0.1KHz	10.0KHz	○
F09.48	Reserved				
F09.49	Reserved				
F09.50	Reserved				

F10—Simple PLC/Multi-speed Function Parameter Group

Function Code	Name	Set Range	Min. Unit	Factory Default	Modification
F10.00	Simple PLC operate setting	Units digit: run mode selection 0:inaction 1:stop after single cycle 2:final value keep after single cycle 3:continuous cycle Tens digit: interrupt run restart mode selection 0:restart from first phase 1:continuous run from phase frequency at interruption 2:continuous run from run frequency at interruption Hundreds digit: PLC run time unit 0:second 1:minute Thousands digit: power-down memory selection 0:no memory 1:phase of reserve power down, frequency power down recording PLC run status: contain power down phase, run frequency, time have run.	1	0000	×
F10.01	Step 1 setting	000H~E22H Units digit: frequency setup 0: Multi-section frequency i (i=1~15) 1:frequency determined by complex frequency of main and auxiliary 2: Reserved Tens digit: operation direction selection 0:forward 1:reversal 2:determine by run command Hundreds digit: ACC/DEC time selection 0: ACC/DEC time 1 1: ACC/DEC time 2 2: ACC/DEC time 3 3: ACC/DEC time 4 4: ACC/DEC time 5 5: ACC/DEC time 6	1	000	○

6 Function parameter schedule graph

		6: ACC/DEC time 7 7: ACC/DEC time 8 8: ACC/DEC time 9 9: ACC/DEC time 10 A: ACC/DEC time 11 B: ACC/DEC time 12 C: ACC/DEC time 13 D: ACC/DEC time 14 E: ACC/DEC time 15			
F10.02	Step 2 setting	000H~E22H	1	000	○
F10.03	Step 3 setting	000H~E22H	1	000	○
F10.04	Step 4 setting	000H~E22H	1	000	○
F10.05	Step 5 setting	000H~E22H	1	000	○
F10.06	Step 6 setting	000H~E22H	1	000	○
F10.07	Step 7 setting	000H~E22H	1	000	○
F10.08	Step 8 setting	000H~E22H	1	000	○
F10.09	Step 9 setting	000H~E22H	1	000	○
F10.10	Step 10 setting	000H~E22H	1	000	○
F10.11	Step 11 setting	000H~E22H	1	000	○
F10.12	Step 12 setting	000H~E22H	1	000	○
F10.13	Step 13 setting	000H~E22H	1	000	○
F10.14	Step 14 setting	000H~E22H	1	000	○
F10.15	Step 15 setting	000H~E22H	1	000	○
F10.16	Step 1 running time	0~6000.0	0.1	10.0	○
F10.17	Step 2 running time	0~6000.0	0.1	10.0	○
F10.18	Step 3 running time	0~6000.0	0.1	10.0	○
F10.19	Step 4 running time	0~6000.0	0.1	10.0	○
F10.20	Step 5 running time	0~6000.0	0.1	10.0	○
F10.21	Step 6 running time	0~6000.0	0.1	10.0	○
F10.22	Step 7 running time	0~6000.0	0.1	10.0	○
F10.23	Step 8 running time	0~6000.0	0.1	10.0	○
F10.24	Step 9 running time	0~6000.0	0.1	10.0	○
F10.25	Step 10 running time	0~6000.0	0.1	10.0	○
F10.26	Step 11 running time	0~6000.0	0.1	10.0	○
F10.27	Step 12 running time	0~6000.0	0.1	10.0	○
F10.28	Step 13 running time	0~6000.0	0.1	10.0	○
F10.29	Step 14 running time	0~6000.0	0.1	10.0	○
F10.30	Step 15 running time	0~6000.0	0.1	10.0	○
F10.31	Multi- frequency 1	0.00Hz~upper limit frequency	0.01Hz	5.00Hz	○
F10.32	Multi- frequency 2	0.00Hz~upper limit frequency	0.01Hz	10.00Hz	○
F10.33	Multi- frequency 3	0.00Hz~upper limit frequency	0.01Hz	20.00Hz	○
F10.34	Multi- frequency 4	0.00Hz~upper limit frequency	0.01Hz	30.00Hz	○
F10.35	Multi- frequency 5	0.00Hz~upper limit frequency	0.01Hz	40.00Hz	○
F10.36	Multi- frequency 6	0.00Hz~upper limit frequency	0.01Hz	45.00Hz	○
F10.37	Multi- frequency 7	0.00Hz~upper limit frequency	0.01Hz	50.00Hz	○
F10.38	Multi- frequency 8	0.00Hz~upper limit frequency	0.01Hz	5.00Hz	○
F10.39	Multi- frequency 9	0.00Hz~upper limit frequency	0.01Hz	10.00Hz	○
F10.40	Multi- frequency 10	0.00Hz~upper limit frequency	0.01Hz	20.00Hz	○
F10.41	Multi- frequency 11	0.00Hz~upper limit frequency	0.01Hz	30.00Hz	○
F10.42	Multi- frequency 12	0.00Hz~upper limit frequency	0.01Hz	40.00Hz	○
F10.43	Multi- frequency 13	0.00Hz~upper limit frequency	0.01Hz	45.00Hz	○
F10.44	Multi- frequency 14	0.00Hz~upper limit frequency	0.01Hz	50.00Hz	○
F10.45	Multi- frequency 15	0.00Hz~upper limit frequency	0.01Hz	50.00Hz	○

F11—Close loop PID run function parameter group					
Function Code	Name	Set Range	Min. Unit	Factory Default	Modification
F11.00	Closed-loop running control selection	0:PID close loop run control invalid 1:PID close loop run control valid	1	0	×
F11.01	Provision channel selection	0:Digital provision 1:A11 analog provision 2:A12 analog provision 3:EAI1 analog provision 4:EAI2 analog provision 5: Pulse provision 6: Communication provision 7: Reserved	1	0	○
F11.02	Feedback channel selection	0: A11 analog input 1: A12 analog input 2: EAI1 analog input (Extend effective) 3: EAI2 analog input (Extend effective) 4: A11+A12 5: A11-A12 6: Min { A11, A12 } 7: Max { A11, A12 } 8: Pulse input	1	0	○
F11.03	Provision channel filtering time	0.01~50.00s	0.01s	0.20s	×
F11.04	Feedback channel filtering time	0.01~50.00s	0.01s	0.10s	×
F11.05	PID output filtering time	0.00~50.00s	0.01s	0.00s	○
F11.06	Provision digital setting	0.00~10.00V	0.01V	1.00V	○
F11.07	Proportion gain Kp	0.000~9.999	0.001	0.100	○
F11.08	Integral gain Ki	0.000~9.999	0.001	0.100	○
F11.09	Differential gain Kd	0.000~9.999	0.001	0.000	○
F11.10	Sample cycle T	0.01~1.00s	0.01s	0.10s	○
F11.11	Deviation limit	0.0~20.0% correspond to provide value percentage	0.1%	2.0%	○
F11.12	PID differential amplitude limit	0.00~100.00%	0.01%	0.10%	○
F11.13	Closed-loop regulation characteristic	0:action 1:reaction	1	0	○
F11.14	Feedback channel Positive-Negative characteristic	0:positive characteristic 1:negative characteristic	1	0	○
F11.15	PID regulation upper limit frequency	0.00Hz~upper limit frequency	0.01Hz	50.00Hz	○
F11.16	PID regulation lower limit frequency	0.00Hz~upper limit frequency	0.01Hz	0.00Hz	○
F11.17	Integral regulation selection	0:when integral arrival separate PID threshold value, stop integral adjusting 1:when integral arrival separate PID threshold value, continue threshold value adjusting	1	0	○
F11.18	PID threshold of the integral separation	0.0~100.0%	0.1%	100.0%	○
F11.19	Preset closed-loop frequency	0.00Hz~upper limit frequency	0.01Hz	0.00Hz	○
F11.20	Holding time of preset	0.0~6000.0s	0.1s	0.0s	○

6 Function parameter schedule graph

	closed-loop frequency				
F11.21	Closed-loop output reversion selection	0:closed-loop output minus, low limit frequency run. 1:closed-loop output minus, reverse run (effect by run direction setting) 2:determined by running demand	1	2	○
F11.22	Closed-loop output Reversion frequency upper limit	0.00Hz~upper limit frequency	0.01Hz	50.00Hz	○
F11.23	Multiple closed-loop provision 1	0.00~10.00V	0.01V	0.00V	○
F11.24	Multiple closed-loop provision 2	0.00~10.00V	0.01V	0.00V	○
F11.25	Multiple closed-loop provision 3	0.00~10.00V	0.01V	0.00V	○
F11.26	Multiple closed-loop provision 4	0.00~10.00V	0.01V	0.00V	○
F11.27	Multiple closed-loop provision 5	0.00~10.00V	0.01V	0.00V	○
F11.28	Multiple closed-loop provision 6	0.00~10.00V	0.01V	0.00V	○
F11.29	Multiple closed-loop provision 7	0.00~10.00V	0.01V	0.00V	○

F12—Constant Pressure Water Supply Function Parameter Group					
Function code	Name	Set range	Min. unit	Factory Default	Modification
F12.00	Constant pressure water supply mode selection	0: no constant pressure water supply 1: select inverter to achieve one drive two mode 2: select extend board to achieve one drive two mode 3: select extend board to achieve one drive three mode 4: select extend board to achieve one drive four mode	1	0	×
F12.01	Target pressure setting	0.000~long-distance pressure gage range	0.001Mpa	0.200Mpa	○
F12.02	Sleep frequency threshold	0.00Hz~upper limit frequency	0.01Hz	30.00Hz	○
F12.03	Awake pressure threshold	0.000~long-distance pressure gage range	0.001Mpa	0.150Mpa	○
F12.04	Sleep delay time	0.0~6000.0s	0.1s	0.0s	○
F12.05	Revival delay time	0.0~6000.0s	0.1s	0.0s	○
F12.06	The range of long-distance manometer	0.001~9.999Mpa	0.001Mpa	1.000Mpa	○
F12.07	allowed deviation of upper limit frequency and lower limit frequency when add or reduce pump	0.1~100.0%	0.1%	1.0%	○
F12.08	Pump switch judging time	0.0~999.9s	0.1s	5.0s	○
F12.09	Electromagnetism contactor switching delay time	0.1~10.0s	0.1s	0.5s	○

F12.10	Automatic switching time interval	0000~9999 minute	1	0	×
F12.11	Revival mode selection	0: Awake by the value of F12.03 1: Awake by the value of F12.12*F12.01	1	1	○
F12.12	Revival pressure coefficient	0.01~0.99	0.01	0.75	○
F12.13	Reserved				
F12.14	Reserved				

F13—Traverse/ Fixed Length Control Function Parameter Group

Function Code	Name	Set Range	Min. Unit	Factory Default	Modification
F13.00	Traverse function selection	0:traverse invalid 1:traverse valid	1	0	×
F13.01	Traverse operating mode	Units digit: enter mode 0:automatically enter 1:terminal enter manually Tens digit: 0:variable swing 1:fixed swing Hundreds digit: traverse halt start mode selection 0:restart 1:start as previous halt record Thousands digit: traverse status reserve selection 0:no reserve 1:reserve	1	0000	×
F13.02	Traverse frequency swing value	0.0~50.0%	0.1%	10.0%	○
F13.03	Sudden-Jump frequency	0.0~50.0%	0.1%	2.0%	○
F13.04	Traverse cycle	0.1~999.9s	0.1s	10.0s	○
F13.05	Triangular wave rising time	0.0~98.0% (traverse cycle)	0.1%	50.0%	○
F13.06	preset frequency of Traverse	0.00~400.00Hz	0.01Hz	0.00Hz	○
F13.07	Traverse preset frequency waiting time	0.0~6000.0s	0.1s	0.0s	○
F13.08	Setting length	0~65535m	1m	0m	○
F13.09	Number of pulses for axis per circle	1~10000	1	1	○
F13.10	Axis perimeter	0.01~100.00cm	0.01cm	10.00cm	○
F13.11	Reserved				
F13.12	Length correction coefficient	0.001~1.000	0.001	1.000	○
F13.13	After length arrival: record length manage	0:automatically reset 1:no change	0	1	○
F13.14	Process of length record when stop	0:automatically reset 1:no change	0	1	○

F14—Vector Control Parameter Group					
Function code	Name	Set Range	Min. Unit	Factory Default	Modification
F14.00	Speed/torque control selection	0: speed control 1: torque control (This parameter is valid when F00.24=1 or 2)	1	0	○
F14.01	Speed loop high speed proportional gain	0.1 ~ 40.0 (This parameter is valid when F00.24=1 or 2)	0.1	20.0	○
F14.02	Speed loop high speed integral time	0.001 ~ 10.000s (This parameter is valid when F00.24=1 or 2)	0.001s	0.040s	○
F14.03	Speed loop low speed proportional gain	0.1 ~ 80.0 (This parameter is valid when F00.24=1 or 2)	0.1	20.0	○
F14.04	Speed loop low speed integral time	0.001 ~ 10.000s (This parameter is valid when F00.24=1 or 2)	0.001s	0.020s	○
F14.05	Speed loop parameter switching frequency	0.00Hz ~ 20.00Hz (This parameter is valid when F00.24=1 or 2)	0.01Hz	5.00Hz	○
F14.06	Low frequency power generation stability coefficient	0 ~ 50 (This parameter is valid when F00.24=1)	1	16	○
F14.07	Current loop proportional gain	1 ~ 500 (This parameter is valid when F00.24=1 or 2)	1	70	○
F14.08	Current loop integral time	0.1 ~ 100.0ms (This parameter is valid when F00.24=1 or 2)	0.1ms	4.0ms	○
F14.09	Motor-driven torque current limit value	0.0 ~ 250.0% (This parameter is valid when F00.24=1 or 2 or 3)	0.1%	180.0%	×
F14.10	Braking torque current limit value	0.0 ~ 250.0% (This parameter is valid when F00.24=1 or 2)	0.1%	180.0%	×
F14.11	Asynchronous motor flux-weakening control coefficient	20.0 ~ 100.0% (This parameter is valid when F00.24=1 or 2)	0.1%	80.0%	○
F14.12	Asynchronous motor Min. flux coefficient	10.0 ~ 80.0% (This parameter is valid when F00.24=2)	0.1%	10.0%	○
F14.13	Torque provision channel selection	0: Digital setting 1: AI1 Analog setting 2: AI2 Analog setting 3: Terminal UP/DOWN adjustment setting 4: communication provision 5: EA11 Analog setting (expansion effective) 6: EA12 Analog setting (expansion effective) 7: rapid pulse setting (X8 terminal needs to choose the corresponding function) 8: terminal pulse width setting (X8 terminal needs to choose the corresponding function) Note: This parameter is valid when F00.24=1 or 2.	1	0	×
F14.14	Torque polarity setting	00 ~ 11 Units digit: torque setting polarity 0: positive 1: negative Tens digit: torque compensation polarity 0: The same as setting direction of torque 1: opposite the setting direction of torque Note: This parameter is valid when F00.24=1 or 2.	1	00	○
F14.15	Torque digital setting value	0.0 ~ 200.0% (This parameter is valid when F00.24=1 or 2)	0.1%	0.0%	○

F14.16	Forward speed limit channel selection in Torque control mode	0: Digital setting 1: AI1 Analog setting 2: AI2 Analog setting 3: Terminal UP/DOWN adjustment setting 4: communication provision 5: EA11 Analog setting (expansion effective) 6: EA12 Analog setting (expansion effective) 7: rapid pulse setting (X8 terminal needs to choose the corresponding function) 8: terminal pulse width setting (X8 terminal needs to choose the corresponding function) Note: This parameter is valid when F00.24=1 or 2.	1	0	×
F14.17	Reverse speed limit channel selection in Torque control mode	0: Digital setting 1: AI1 Analog setting 2: AI2 Analog setting 3: Terminal UP/DOWN adjustment setting 4: Communication provision 5: EA11 Analog setting (expansion effective) 6: EA12 Analog setting (expansion effective) 7: Rapid pulse setting (X8 terminal needs to choose the corresponding function) 8: Terminal pulse width setting (X8 terminal needs to choose the corresponding function) Note: This parameter is valid when F00.24=1 or 2.	1	0	×
F14.18	Forward speed limit value in Torque control mode	0.00Hz~upper limit frequency (This parameter is valid when F00.24=1 or 2.)	0.01Hz	50.00Hz	○
F14.19	Reverse speed limit value in Torque control mode	0.00Hz~upper limit frequency (This parameter is valid when F00.24=1 or 2.)	0.01Hz	50.00Hz	○
F14.20	Torque Accelerate/Decelerate time setting	0.000~60.000s (This parameter is valid when F00.24=1 or 2.)	0.001s	0.100s	○
F14.21	Torque compensation	0.0~100.0% (This parameter is valid when F00.24=1 or 2.)	0.1%	0.0%	○
F14.22	Positive torque gain regulation coefficient	50.0~150.0% (This parameter is valid when F00.24=1 or 2.)	0.1%	100.0%	○
F14.23	Negative torque gain regulation coefficient	50.0~150.0% (This parameter is valid when F00.24=1 or 2.)	0.1%	100.0%	○
F14.24	Flux braking coefficient	0.0~300.0% (This parameter is valid when F00.24=1 or 2.)	0.1%	0.0%	○
F14.25	Pre-excitation start-up time constant	0.1~3.0 (This parameter is valid when F00.24=1)	0.1	0.5	×
F14.26	Speed loop proportional gain	0.010~6.000 (This parameter is valid when F00.24=3)	0.001	0.500	○
F14.27	Speed loop integral time constant	0.010~9.999 (This parameter is valid when F00.24=3)	0.001	0.360	○
F14.28	Motor stabilization coefficient	10~300 (This parameter is valid when F00.24=3)	1	100	○
F14.29	Compensation gain of vibration restrain	100.0~130.0% (This parameter is valid when F00.24=3)	0.1%	100.0%	○
F14.30	Torque compensation limit frequency	0.00Hz~upper limit frequency (This parameter is valid when F00.24=1 or 2.)	0.01Hz	0.00Hz	○

6 Function parameter schedule graph

F15—Asynchronous Motor Parameter Group					
Function code	Name	Set Range	Min. Unit	Factory Default	Modification
F15.00	Reserved				
F15.01	Asynchronous motor rated power	0.1~999.9KW	0.1KW	Base on motor type	×
F15.02	Asynchronous motor rated voltage	1~690V	1V	Base on motor type	×
F15.03	Asynchronous motor rated current	0.1~6553.5A	0.1A	Base on motor type	×
F15.04	Asynchronous motor rated frequency	0.00~400.00Hz	0.01Hz	Base on motor type	×
F15.05	Asynchronous motor rated rotational speed	0~60000r/min	1r/min	Base on motor type	×
F15.06	Asynchronous motor poles No.	1~7	1	2	×
F15.07	Asynchronous motor stator resistance	0.001~65.535Ω (inverter power<7.5KW)	0.001Ω	Base on motor type	×
		0.0001~6.5535Ω(inverter power≥7.5KW)	0.0001Ω		
F15.08	Asynchronous motor rotor resistance	0.001~65.535Ω (inverter power<7.5KW)	0.001Ω	Base on motor type	×
		0.0001~6.5535Ω(inverter power≥7.5KW)	0.0001Ω		
F15.09	Asynchronous motor leakage inductance	0.01~655.35mH (inverter power<7.5KW)	0.01mH	Base on motor type	×
		0.001~65.535mH (inverter power≥7.5KW)	0.001mH		
F15.10	Asynchronous motor mutual inductance	0.1~6553.5mH (inverter power<7.5KW)	0.1mH	Base on motor type	×
		0.01~655.35mH (inverter power≥7.5KW)	0.01mH		
F15.11	Asynchronous motor no load current	0.01~655.35A	0.01A	Base on motor type	×
F15.12	Reserved				
F15.13	Reserved				
F15.14	Reserved				
F15.15	Reserved				
F15.16	Reserved				
F15.17	Reserved				
F15.18	Reserved				
F15.19	Motor parameter self-tuning selection	0: Inaction 1: asynchronous motor stop to self-adjusting 2: asynchronous motor rotate no-load to self-adjusting 3: Reserved Note: ① Before adjustment, The nameplate data should be setting directly. ② Motor parameter group can have special default values, or can be modified by users, or can be self-adjusted. ③ when parameter F15.01 is modified, the	1	0	×

		other parameters of the motor will turn into default values automatically.			
F15.20	Reserved				
F15.21	Reserved				
F15.22	Reserved				

F16—Closed loop encoder parameter group

Function code	Name	Set Range	Min. Unit	Factory Default	Modification
F16.00	Reserved				
F16.01	Encoder line number	1~10000	1	1024	○
F16.02	Direction of encoder	Units digit: AB phase sequence 0: Forward direction 1: Reverse direction Tens digit: Reserved	1	00	×
F16.03	Encoder fractional frequency coefficient	0.001~60.000	0.001	1.000	○
F16.04	Encoder filtering coefficient	5~100	1	15	○
F16.05	Reserved				
F16.06	Reserved				
F16.07	Reserved				
F16.08	Reserved				
F16.09	Reserved				
F16.10	Reserved				
F16.11	Reserved				
F16.12	Reserved				
F16.13	Reserved				

F17—Reserved Parameter Group 1

Function code	Name	Set Range	Min. Unit	Factory Default	Modification
F17.00 ~ F17.20	Reserved				

F18—Enhance Control Parameter Group

Function code	Name	Set Range	Min. Unit	Factory Default	Modification
F18.00	Operation panel control frequency binding	0:no binding 1:operation keyboard digital setup 2:A11 analog setup 3:A12 analog setup 4:terminal UP/DOWN adjusting setup 5:communication provide(Modbus and external bus use the same main frequency storage) 6:EA11 analog setup(extension valid) 7:EA12 analog setup(extension valid) 8:high speed pulse setup(X8 terminal need choose the relative function) 9:terminal pulse width setup(X8 terminal	1	0	○

6 Function parameter schedule graph

		need choose the relative function) 10:terminal encoder provide(decide by X1, X2) 11~15: Reserved			
F18.01	Terminal control frequency binding	Same as above	1	0	○
F18.02	Communication control frequency binding	Same as above	1	0	○
F18.03	Digital frequency integral function selection	Units digit: keyboard UP/DW integral control 0:integral function 1:no integral function Tens digit: terminal UP/DW integral control 0:integral function 1:no integral function	1	00	○
F18.04	Keyboard UP/DOWN integral rate	0.01~50.00Hz	0.01Hz	0.10Hz	○
F18.05	Keyboard no integral single step's size setup	0.01~10.00Hz	0.01Hz	0.01Hz	○
F18.06	Terminal UP/DOWN integral rate	0.01~50.00Hz	0.01Hz	0.20Hz	○
F18.07	Terminal no integral single step's size setup	0.01~10.00Hz	0.01Hz	0.10Hz	○
F18.08	Droop control decline frequency	0.00~10.00Hz	0.01Hz	0.00Hz	○
F18.09	Setup accumulate power on time	0~65535 hours	1	0	○
F18.10	Setup accumulate run time	0~65535 hours	1	0	○
F18.11	Timing run function enable	0:invalid 1:valid	1	0	○
F18.12	Timing run stop time	0.1~6500.0Min	0.1Min	2.0Min	○
F18.13	Currently run arrival time	0.0~6500.0Min	0.1Min	1.0Min	○
F18.14	Keyboard UP/DOWN selection under monitor mode	0:keyboards frequency provide value adjusting 1:PID digital provide value adjusting 2~6: Reserved	1	0	○
F18.15	V/F vibration restrain end frequency	0.00Hz~upper limit frequency	0.01Hz	50.00Hz	○
F18.16	Torque closed loop control selection	0: Torque open-loop control 1: Torque closed-loop control Note: This parameter is valid when F00.24=1 or 2	1	1	○
F18.17	Reserved				
F18.18	Reserved				
F18.19	Reserved				
F18.20	Reserved				
F18.21	Reserved				
F18.22	Reserved				
F18.23	Reserved				
F18.24	Reserved				

F19—Protective Relevant Function Parameter Group					
Function code	Name	Set Range	Min. Unit	Factory Default	Modification
F19.00	Power off restart waiting time	0.0~20.0s (0 means no start function)	0.1s	0.0s	×
F19.01	Fault self-recovery times	0~10 (0 means no automatic reset function)	1	0	×
F19.02	Fault self-recovery interval time	0.5~20.0s	0.1s	5.0s	×
F19.03	Motor overload protection action selection	0:alarm, continuous run 1:alarm, stop run as halt mode 2:fault, free halt	1	2	×
F19.04	Motor overload protection coefficient	20.0~200.0% (motor rated current)	0.1%	150.0%	×
F19.05	Inverter overload pre-alarm detection selection	0:detection all the time 1:detection as constant velocity	1	0	×
F19.06	Inverter overload pre-alarm detection level	20~180% (inverter rated current)	1%	130%	○
F19.07	Inverter overload pre-alarm delay time	0.0~20.0s	0.1s	5.0s	○
F19.08	Motor underload alarm detection level	0.0~120.0% (motor rated current)	0.1%	50.0%	○
F19.09	Motor underload alarm detection time	0.1~60.0s	0.1s	2.0s	○
F19.10	Motor underload alarm detection action	Units digit: detection selection 0:no detection 1:detection all the time when run 2:detection only when constant velocity Tens digit: action selection 0:alarm, continuous run 1:alarm, stop run as halt mode 2:fault, free halt	1	00	○
F19.11	Input& output phase loss, short circuit detection action	Units digit: input phase loss 0:no detection 1:fault, free halt Tens digit: output phase loss 0:no detection 1:fault, free halt Hundreds digit: power-on on earth short circuit protect detection enable 0:no detection 1:fault, free halt Thousands digit: operation on earth short circuit protect detection enable 0:no detection 1:fault, free halt	1	1111	○
F19.12	Over voltage stall selection	0:forbid 1:allowed	1	1	×
F19.13	Over voltage stall protection voltage	120~150% (rated busbar voltage)	1%	125%	×
F19.14	Automatic current limit level	110~230% (G type rated current)	1%	170%	×
F19.15	Frequency decline rate of automatic current limit	0.00~99.99Hz/s	0.01Hz/s	10.00Hz/s	×

6 Function parameter schedule graph

F19.16	Automatic current limit action selection	0:constant velocity invalid 1:constant velocity valid	1	0	×
F19.17	Rapid current-limiting coefficient	150%~250% (G type rated current)	1%	230%	×
F19.18	Motor run section selection when instant power off	0:forbid 1:allowed	1	0	×
F19.19	Frequency droop rate when instant power off	0.00~99.99Hz/s	0.01Hz/s	10.00Hz/s	×
F19.20	Voltage rebound estimate time when instant power off	0.00~10.00s	0.01s	0.10s	×
F19.21	Action estimate voltage when instant power off	60~100%(rated busbar voltage)	1%	80%	×
F19.22	Allowed the longest off time when instant power off	0.30~5.00s	0.01s	2.00s	×
F19.23	Terminal external device fault action selection	0:alarm, continuous run 1:alarm, stop run as halt mode 2:fault, free halt	1	2	×
F19.24	Power on terminal protection selection	0:invalid 1:valid	1	0	×
F19.25	Provide lost detection value	0~100%	1%	0%	○
F19.26	Provide lost detection time	0.0~20.0s	0.1s	0.5s	○
F19.27	Feedback lost detection value	0~100%	1%	12%	○
F19.28	Feedback lost detection time	0.0~20.0s	0.1s	0.5s	○
F19.29	Deviation magnitude abnormal detection value	0~100%	1%	50%	○
F19.30	Deviation magnitude abnormal detection time	0.0~20.0s	0.1s	0.5s	○
F19.31	Protection action selection 1	Units digit: PID provide loss detection act 0:no detection 1:alarm, continue run 2:alarm, stop run as halt mode 3:fault, free halt Tens digit: PID feedback loss detection act 0:no detection 1:alarm, continue run 2:alarm, stop run as halt mode 3:fault, free halt Hundreds digit: PID error value abnormal detect action 0:no detection 1:alarm, continue run 2:alarm, stop run as halt mode 3:fault, free halt	1	000	○
F19.32	Protection action selection 2	Units digit: communication abnormal action: include communication time out and error 0:alarm, continue run 1:alarm, stop run as halt mode 2:fault, free halt	1	1200	×

		Tens digit: E ² PROM abnormal action selection 0:alarm, continue run 1:alarm, stop run as halt mode 2:fault, free halt Hundreds digit: contactor abnormal action 0:alarm, continue run 1:alarm, stop run as halt mode 2:fault, free halt Thousands digit: running lack-Voltage fault display action selection. 0:no detection 1:fault, free halt			
F19.33	Reserved				
F19.34	Reserved				
F19.35	Fault indication and clock during the period of recovery	Units digit: fault indication selection during the period of fault reset automatically 0:action 1:no action Tens digit: fault clock function selection: to achieve fault display before power down: etc. 0:forbid 1:open	1	00	×
F19.36	Continuous run frequency selection when alarm	Match up with protect action 0:run at the frequency setup by now 1:run at the frequency of upper limit 2:run at the frequency of low limit 3:run at the frequency of abnormal for standby	1	0	×
F19.37	Abnormal standby frequency	0.00Hz~upper limit frequency	0.01Hz	10.00Hz	×
F19.38	Encoder disconnection detection time	0.0~8.0s(No detection when value is 0)	0.1s	0.0s	○
F19.39	Over speed (OS) detection time	0.0~120.0%(equals upper limit frequency)	0.1%	120.0%	○
F19.40	Over speed (OS) detection time	0.0~20.00s (No detection when value is 0)	0.01s	0.00s	○
F19.41	Detection value when speed deviation is too large	0.0~50.0%(equals upper limit frequency)	0.1%	10.0%	○
F19.42	Detection time when speed deviation is too large	0.00~20.00s (No detection when value is 0)	0.01s	0.00s	○
F19.43	Overvoltage suppression coefficient	0.0~100.0%	0.1%	90.0%	○
F19.44	Reserved				

F20—Internal Virtual Input Output Node Parameter Group

Function code	Name	Set Range	Min. Unit	Factory Default	Modification
F20.00	Virtual input VDI1 function selection	0~90	1	0	○
F20.01	Virtual input VDI2 function selection	0~90	1	0	○
F20.02	Virtual input VDI3 function selection	0~90	1	0	○

6 Function parameter schedule graph

F20.03	Virtual input VDI4 function selection	0~90	1	0	○
F20.04	Virtual input VDI5 function selection	0~90	1	0	○
F20.05	Virtual output VDO1 function selection	0~60	1	0	○
F20.06	Virtual output VDO2 function selection	0~60	1	0	○
F20.07	Virtual output VDO3 function selection	0~60	1	0	○
F20.08	Virtual output VDO4 function selection	0~60	1	0	○
F20.09	Virtual output VDO5 function selection	0~60	1	0	○
F20.10	Virtual output VDO1 open delay time	0.00~600.00s	0.01s	0.00s	○
F20.11	Virtual output VDO2 open delay time	0.00~600.00s	0.01s	0.00s	○
F20.12	Virtual output VDO3 open delay time	0.00~600.00s	0.01s	0.00s	○
F20.13	Virtual output VDO4 open delay time	0.00~600.00s	0.01s	0.00s	○
F20.14	Virtual output VDO4 open delay time	0.00~600.00s	0.01s	0.00s	○
F20.15	Virtual output VDO1 close delay time	0.00~600.00s	0.01s	0.00s	○
F20.16	Virtual output VDO2 close delay time	0.00~600.00s	0.01s	0.00s	○
F20.17	Virtual output VDO3 close delay time	0.00~600.00s	0.01s	0.00s	○
F20.18	Virtual output VDO4 close delay time	0.00~600.00s	0.01s	0.00s	○
F20.19	Virtual output VDO5 close delay time	0.00~600.00s	0.01s	0.00s	○
F20.20	Virtual input VDI enable control	00~FF	1	00	○
F20.21	Virtual input VDI status digital setup	00~FF	1	00	○
F20.22	Virtual input/output connection	00~FF Bit0:VDI1 and VDO1 connection 0:positive logic 1:negative logic Bit1:VDI2 and VDO2 connection 0:positive logic 1:negative logic Bit3:VDI3 and VDO3 connection 0:positive logic 1:negative logic Bit4:VDI4 and VDO4 connection 0:positive logic 1:negative logic Bit4:VDI5 and VDO5 connection 0:positive logic 1:negative logic	1	00	○

F21—Reserved Parameter Group 2					
Function code	Name	Set Range	Min. Unit	Factory Default	Modification
F21.00~F21.21	Reserved				

F22—Reserved Parameter Group 3					
Function code	Name	Set Range	Min. Unit	Factory Default	Modification
F22.00~F22.17	Reserved				

F23—Reserved Parameter Group 4					
Function code	Name	Set Range	Min. Unit	Factory Default	Modification
F23.00~F23.17	Reserved				

F24—Reserved Parameter Group 5					
Function code	Name	Set Range	Min. Unit	Factory Default	Modification
F24.00~F24.13	Reserved				

F25—User Definition Display Parameter Group					
Function code	Name	Set Range	Min. Unit	Factory Default	Modification
F25.00	User Function Code 1	F00.00~F25.xx	0.01	25.00	○
F25.01	User Function Code 2	F00.00~F25.xx	0.01	25.00	○
F25.02	User Function Code 3	F00.00~F25.xx	0.01	25.00	○
F25.03	User Function Code 4	F00.00~F25.xx	0.01	25.00	○
F25.04	User Function Code 5	F00.00~F25.xx	0.01	25.00	○
F25.05	User Function Code 6	F00.00~F25.xx	0.01	25.00	○
F25.06	User Function Code 7	F00.00~F25.xx	0.01	25.00	○
F25.07	User Function Code 8	F00.00~F25.xx	0.01	25.00	○
F25.08	User Function Code 9	F00.00~F25.xx	0.01	25.00	○
F25.09	User Function Code 10	F00.00~F25.xx	0.01	25.00	○
F25.10	User Function Code 11	F00.00~F25.xx	0.01	25.00	○
F25.11	User Function Code 12	F00.00~F25.xx	0.01	25.00	○
F25.12	User Function Code 13	F00.00~F25.xx	0.01	25.00	○
F25.13	User Function Code 14	F00.00~F25.xx	0.01	25.00	○
F25.14	User Function Code 15	F00.00~F25.xx	0.01	25.00	○
F25.15	User Function Code 16	F00.00~F25.xx	0.01	25.00	○
F25.16	User Function Code 17	F00.00~F25.xx	0.01	25.00	○
F25.17	User Function Code 18	F00.00~F25.xx	0.01	25.00	○
F25.18	User Function Code 19	F00.00~F25.xx	0.01	25.00	○
F25.19	User Function Code 20	F00.00~F25.xx	0.01	25.00	○

6 Function parameter schedule graph

F25.20	User Function Code 21	F00.00~F25.xx	0.01	25.00	○
F25.21	User Function Code 22	F00.00~F25.xx	0.01	25.00	○
F25.22	User Function Code 23	F00.00~F25.xx	0.01	25.00	○
F25.23	User Function Code 24	F00.00~F25.xx	0.01	25.00	○
F25.24	User Function Code 25	F00.00~F25.xx	0.01	25.00	○
F25.25	User Function Code 26	F00.00~F25.xx	0.01	25.00	○
F25.26	User Function Code 27	F00.00~F25.xx	0.01	25.00	○
F25.27	User Function Code 28	F00.00~F25.xx	0.01	25.00	○
F25.28	User Function Code 29	F00.00~F25.xx	0.01	25.00	○
F25.29	User Function Code 30	F00.00~F25.xx	0.01	25.00	○

F26—Fault Record Function Parameter Group					
Function Code	Name	Set Range	Min. Unit	Factory Default	Modification
F26.00	The last fault record	0:no fault 1:overcurrent at acceleration 2:overcurrent at deceleration 3:overcurrent at constant speed 4:overvoltage at acceleration 5:overvoltage at deceleration 6:overvoltage at constant speed 7:overvoltage at motor halt 8:undervoltage at run 9:drive overload protection 10:motor overload protection 11:motor underload protection 12:input phase loss 13:output phase loss 14:inverter module protection 15:short circuit to earth at run 16:short circuit to earth when power on 17:drive overheat 18:external device fault 19:current detect circuit fault 20:external interference 21:internal interference—main clock etc 22:PID provide lost 23:PID feedback lost 24:PID error value abnormal 25:terminal protection activate 26:communication fault 27~29:reserve 30:EEROM read-write error 31:temperature detection disconnection 32:auto-tunning fault 33:contactor abnormal 34:factory fault 1 35:factory fault 2 36:capacitor overheat(few mode with overheat protection) 37: encoder disconnection 38: over-speed protection 39: protection when speed deviation is too large 40~50: Reserved	1	0	*
F26.01	The last two fault	Same as above	1	0	*

	records				
F26.02	The last three fault records	Same as above	1	0	*
F26.03	The last four fault records	Same as above	1	0	*
F26.04	Setup frequency at the last one fault	0.00Hz~upper limit frequency	0.01Hz	0.00Hz	*
F26.05	Output frequency at the last one fault	0.00Hz~upper limit frequency	0.01Hz	0.00Hz	*
F26.06	Output current at the last one fault	0.0~6553.5A	0.1A	0.0A	*
F26.07	DC busbar voltage at the last one fault	0.0~6553.5V	0.1V	0.0V	*
F26.08	Module temperature at the last one fault	0~125℃	1℃	0℃	*
F26.09	Input terminal status at the last one fault			0	*
F26.10	Accumulated run time at the last one fault	0~65535min	1min	0min	*
F26.11	Setup frequency at the last two fault	0.00Hz~upper limit frequency	0.01Hz	0.00Hz	*
F26.12	Output frequency at the last two fault	0.00Hz~upper limit frequency	0.01Hz	0.00Hz	*
F26.13	Output current at the last two fault	0.0~6553.5A	0.1A	0.0A	*
F26.14	DC busbar voltage at the last two fault	0.0~6553.5V	0.1V	0.0V	*
F26.15	Module temperature at the last two fault	0~125℃	1℃	0℃	*
F26.16	Input terminal status at the last two fault			0	*
F26.17	Accumulated run time at the last two fault	0~65535min	1min	0min	*

F27—Password and Manufacturer Function Parameter Group

Function Code	Name	Set Range	Min. Unit	Factory Default	Modification
F27.00	User password	00000~65535	1	00000	○
F27.01	Manufacturer password	00000~65535	1	00000	○

C—Monitor Function Parameter Group					
Function Code	Name	Set Range	Min. Unit	Factory Default	Modification
C-00	Display the parameter of F00.01, F00.07 definition				
C-01	Display the parameter of F00.02, F00.08 definition				
C-02	Display the parameter of F00.03, F00.09 definition				
C-03	Display the parameter of F00.04, F00.10 definition				
C-04	Display the parameter of F00.05, F00.11 definition				
C-05	Display the parameter of F00.06, F00.12 definition				

(1)corresponding relationship of input terminal status as below:

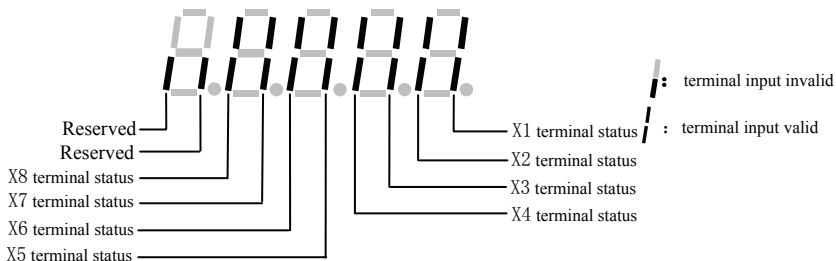

(2)Corresponding relationship of standard output terminal status as below:

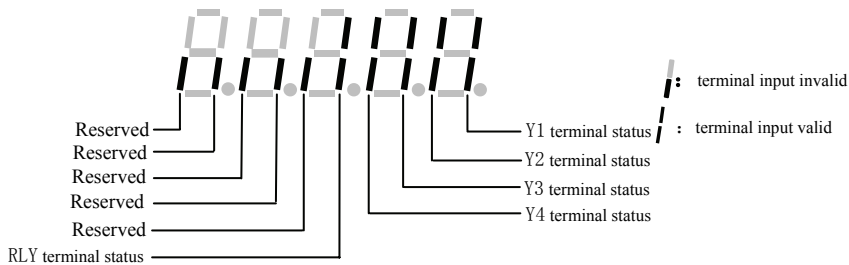

(3)Corresponding relationship of communication virtual input terminal status as below:

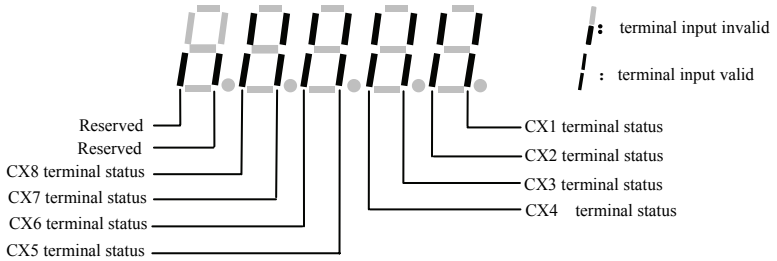

(4)Drive status:

- BIT0:1=busbar voltage setup
- BIT1:1=common run command valid
- BIT2:1=jog run command valid
- BIT3:1=drive run period
- BIT4:1=current run direction to reverse
- BIT5:1=run command direction to reverse
- BIT6:1=deceleration brake period
- BIT7:1=motor acceleration period
- BIT8:1=motor deceleration period
- BIT9: 1= drive alarm
- BIT10: 1= drive fault
- BIT11: 1= current limited period
- BIT12: 1= fault self-recovery period
- BIT13: 1= self-adjusting period
- BIT14: 1= free halt status
- BIT15: 1= speed tracking start

7 Detailed function specification

The parameter function code of this chapter listed content as below:

Code No.	Description	Setup Range/Explanation	Factory Default
----------	-------------	-------------------------	-----------------

7.1 System Parameter Group: F00

F00.00	Parameter group display control	Range: 0~3	0
--------	---------------------------------	------------	---

0: Basic list mode. Display only F00, F01, F02, F03 basic control parameter group and F26 fault record parameter group.

1: Middle list mode. Display all parameter except for extension: virtual and reserve parameter group.

2: Senior list mode. All parameter groups can be displayed.

3: User list mode. Display parameter defined by user: and monitor parameter: F00.00 display all the time.



Note

F00.00 display all the time. Under intermediate menu mode: irrelevant parameter group can be covered according to different control mode.

F00.01	C-00 display parameter selection when operation	Range: 0~65	51
F00.02	C-01 display parameter selection when operation	Range: 0~65	2
F00.03	C-02 display parameter selection when operation	Range: 0~65	4
F00.04	C-03 display parameter selection when operation	Range: 0~65	5
F00.05	C-04 display parameter selection when operation	Range: 0~65	6
F00.06	C-05 display parameter selection when operation	Range: 0~65	9

The above parameter display when inverter run by C-00~C-05 parameter groups, pressing to switch between these parameters.



Pressing and then return to C-00 parameter monitor.



For example: pressing parameter switch from C-00 to C-01: continuous pressing the same button: parameter switch from C-01 to C-02: then pressing return to C-00 parameter monitor.

- 0: Main setup frequency (0.01Hz)**
- 1: Auxiliary setup frequency (0.01Hz)**
- 2: Setup frequency (0.01Hz)**
- 3: Output frequency (0.01Hz)**
- 4: Output current(0.1A)** (display 0.01A below 11KW)
- 5: Output voltage (1V)**
- 6: DC busbar voltage (0.1V)**
- 7: Motor speed (1 circle/min)**
- 8: Motor line velocity (1 circle/min)**
- 9: Inverter temperature (1℃)**
- 10: Run time already this time (0.1min)**
- 11: Current accumulate run time (1h)**
- 12: Current accumulate power-on time (1h)**
- 13: Inverter status** (displays the working state of inverter, show it with decimalism, after change it into binary, the definition is on the parameter details.)
- 14: Input terminal status**
- 15: Output terminal status**
- 16: Extension output terminal status**
- 17: Extension input terminal status**
- 18: Communication virtual input terminal status**
- 19: Internal virtual input node status**
- 20: Analog input AI1 (before checkout)(0.01V / 0.01mA)**
- 21: Analog input AI2 (before checkout)(0.01V / 0.01mA)**
- 22: Extension analog input EAI1 (before checkout)(0.01V / 0.01mA)**
- 23: Extension analog input EAI2 (before checkout)(0.01V / 0.01mA)**
- 24: Analog AO1 output (after correction) (0.01V /0.01mA)**
- 25: Analog AO2 output (after correction) (0.01V or 0.01mA)**
- 26: Extension analog EAO1 output (0.01V /0.01mA)**
- 27: Extension analog EAO2 output (0.01V /0.01mA)**
- 28: External pulse input frequency (1Hz)**
- 29: Reserved**
- 30: Process PID provide (0.01V)**
- 31: Process PID feedback (0.01V)**
- 32: Process PID deviation (0.01V)**
- 33: Process PID output (0.01Hz)**
- 34: Simple PLC current segment No.**
- 35: External multi-speed current segment No.**

- 36: Constant pressure water supply provide pressure (0.001Mpa)**
37: Constant pressure water supply feedback pressure (0.001Mpa)
38: Constant pressure water supplies relay status
39: Current length (1M)
40: Accumulate length (1M)
41: Current internal count value
42: Current internal time value (0.1s)
**43: Run command setup channel (0: keyboard 1: terminal
2: communication)**
44: Main frequency provide channel
45: Auxiliary frequency provide channel
46: Rated current (0.1A)
47: Rated voltage (1V)
48: Rated power (0.1KW)
49, 50: Reserved
51: The frequency after deceleration (0.01Hz)
**52: Motor rotator frequency (0.01Hz) (the frequency estimate on the
open-loop ,actual measurement for close-loop)**
53 :Present provide torque (relative to rated torque, it has direction)
54: Present output torque (relative to rated torque, it has direction)
55: Present torque current (0.1A)
56: The present flux current (0.1A)
57~65: Reserved

F00.07	C-00 display parameter selection when stop	Range: 0~65	2
F00.08	C-01 display parameter selection when stop	Range: 0~65	6
F00.09	C-02 display parameter selection when stop	Range: 0~65	48
F00.10	C-03 display parameter selection when stop	Range: 0~65	14
F00.11	C-04 display parameter selection when stop	Range: 0~65	20
F00.12	C-05 display parameter selection when stop	Range: 0~65	9

The above parameter display when inverter stop by C-00~C-05 parameter group, pressing  to switch between these parameters. Pressing  and then

return to C-00 parameter monitor. For example: pressing  parameter switch from C-00 to C-01, continuous pressing the same button: parameter switch from C-01 to C-02: then pressing  return to C-00 parameter monitor. Monitor contents various as different monitor parameter: refer to parameter F00.01.



Note

Monitor parameter group C-00~C-05 have run and stop modes. For example C-00 display different physical value under run and stop two modes.

F00.13	Power-on fault monitor parameter selection	Range: 0~5	0
---------------	---------------------------------------------------	-------------------	----------

When the parameter power on first time: C monitor parameter group display under drive run or stop status, For example F00.13=1, power on or stop to monitor, display parameter setup by C-01;when F00.02=3, F00.08=6, power on, inverter stops, busbar voltage display; inverter runs, output frequency and keypad display. Pressing  monitor C-00 for the setting motor value.

F00.14	Parameter operation control	Range: units digit: 0~2 tens digit: 0~5 hundreds digit: 0~4	000
---------------	------------------------------------	----------------------------------------------------------------------------	------------

Units digit: To define which parameters will be allowed to modify.

0: All parameters are allowed to modification.

1: Except this parameter, the other parameter is not allowed to modification.

2: Except F01.01, F01.04 and this parameter, the others parameter are not allowed to modification.

Tens digit: To define which parameters will be resumed factory default value

0: No action.

1: All parameters return to default.(not include fault record parameter group(F26 group) parameter).

2: Except for motor parameter: all parameters return to default. (not include F15 and F26 group parameter).









3: Extension parameter return to default.(only F21~F24 group parameter return to default).

4: Virtual parameter return to default.(only F20 group parameter return to default).

5: Fault record return to default. (Only fault record parameter group (F26 group) restores factory default).



Hundreds digit: Locked key that definite the keypad when locking function is valid.

0: All locked.

- 1: Except  button: the others locked.
- 2: Except , ,  button: the others locked
- 3: Except ,  button: the others locked
- 4: Except ,  button: the others locked



Note

1. In factory status, the unit of this function code parameter is 0, and it is default and allowed to change all the other function code parameters: when user finish: and want to change the function code setup: this function code parameter should set up 0 first. When all changes finish and need to do parameter protect: this function code setup into the IP grade you need.
2. The decade recovers to 0 automatically after record remove or factory default operation.
3. When the third of parameter F00.14 finish setup:  button pressing lasting for 2 seconds to lock keyboard and relevant keyboard key: when need to unlock the keyboard: press the  button for 2 seconds.

F00.15	Button function selection	Range: units digit: 0,1 tens digit: 0~9 hundreds digit: 0,1 thousands digit: 0,1	0001
--------	---------------------------	-------------------------------------------------------------------------------------------	------

Units digit: panel  button selection

0: Reversal command action button

1: Jog action button

Tens digit: multi-function  button function selection

0: Invalid.

1: Jog run. Multi-function button as jog run button: run direction decided by unit bit of F01.16. After setting  function, the jog run function on the keypad is invalid.

2: For/rev switching. Press this button to change the run direction when run: then press the same button change to another direction. This function key is not used as start key, only for signal switch

3: Free stop. Setup free stop function and stop mode F02.11 the same function with 1 Jog run.

4: Switching to run command provide mode as the setup order of F00.16.

5: For/rev torque switching. After this function is valid, it can realize the direction switching after torque model.

6~9: Reserved

Hundredth: terminal run command control

0: keypad  is invalid.

1: keypad  is valid.

Thousandth: communication run command control

0: keypad  is invalid.

1: keypad  is valid.

F00.16	Multi-function key run command channel switching order selection	Range: 0~3	0
---------------	-------------------------------------------------------------------------	-------------------	----------

0: Keyboard control→terminal control→communication control

1: Keyboard control←→terminal control

2: Keyboard control←→communication control

3: Terminal control←→communication control

These parameters cooperate with multi-function key to run command channel switching function: with special switch to command channel switching order.

1. Command channel priority terminal switch to (terminal function code 49,50,51)→terminal run command channel selection (terminal function code 52,53)→multi-function key switch→F01.15, when switching to terminal control, be sure the terminal command invalid. Terminal switch to and terminal run command channel selection refer to F08 group parameter about the detailed description of terminal function.

2. We suggest alter the mode at the stop state.



Note

F00.17	Motor speed display coefficient	Range: 0.1~999.9%	100.0%
---------------	----------------------------------------	--------------------------	---------------

This function code is used to check speed scale display error, there is no effect to motor actual speed.

F00.18	Line velocity display coefficient	Range: 0.1~999.9%	1.0%
---------------	------------------------------------------	--------------------------	-------------

This function code is used to check speed scale display error, there is no effect to motor actual speed.

F00.19	Extended Port parts set	Range: 0~10	0
---------------	--------------------------------	--------------------	----------

0: Expansion card invalid

1: Reserved**2: Multi pump water supply card****3: Incremental PG encoder****4~10: Reserved**

This function is for extended port expansion card parameter, after setting expansion card, F00.19 will choose the expansion card number accordingly, then we can use the expansion card normally. For example, when Extended Port add PG expansion card, F00.19 should be set to 3.

F00.20	Analog input terminal configuration	Range: units digit: 0,1 tens digit: 0,1 hundreds digit: 0~2 thousands digit: 0~2	0000
---------------	--------------------------------------------	-----------------------------------------------------------------------------------------------------	-------------

This parameter can configure analog input AI1, AI2, EAI1, EAI2 to be current input type or voltage input type.

Units digit: AI1 configuration

0:0~10V input**1:4~20mA input**

Tens digit: AI2 configuration

0:-10~10V input**1:4~20mA input**

Hundreds digit: EAI1 configuration

0:0~10V input**1:-10~10V input****2:4~20mA input**

Thousands digit: EAI2 configuration

0:0~10V input**1:-10~10V input****2:4~20mA input****Note**

Dial switching(SW1,SW2)under the left corner of CPU to the corresponding position: when AI1,AI2 configuration.

F00.21	Analog output terminal configuration	Range: units digit: 0,1 tens digit: 0,1 hundreds digit: 0,1 thousands digit: 0,1	0000
---------------	---------------------------------------------	-----------------------------------------------------------------------------------------------------	-------------

This parameter can configure AO1, AO2, EAO1, EAO2 analog signal output to be voltage type or current type.

Units digit: AO1 configuration

0:0~10V output

1:4~20mA output

Tens digit: AO2 configuration

0:0~10V output**1:4~20mA output**

Hundreds digit: EAO1 configuration

0:0~10V output**1:4~20mA output**

Thousands digit: EAO2 configuration

0:0~10V output**1:4~20mA output**

Note

Dial switching(SW1,SW2)under the left corner of CPU to the corresponding position: when AI1,AI2 configuration.

F00.22	Y output terminal configuration	Range: units digit: Reserved tens digit: Reserved hundreds digit: Reserved thousands digit: 0,1	0000
---------------	----------------------------------------	--------------------------------------------------------------------------------------------------------------------	-------------

Units digit ~ hundreds digit: Reserved

Thousands digit: Y4 output configuration

0: Open collector output**1: DO output**

The thousands digit decide the Y4 output terminal type, when 0 means open collector output, when 1 means high speed pulse DO output.

F00.23	G/P type setup	Range: 0, 1	0
---------------	-----------------------	--------------------	----------

0:G type. Adapt to constant torque load type.**1:P type.** Adapt to fan & pump load type.

EN500/EN600 integrates G/P type design in full power range. F15 group motor relative parameter will change automatically according to the G or P type.



Note

P type machine only can support V/F control .

F00.24	Motor control model	Range: 0~2	0
---------------	----------------------------	-------------------	----------

0: V/F control

If we need to start the fan and water pump application , or the inverter should drive one more AC motors, please choose the V/F control mode, when drive parts of the synchronous machines, we also can choose V/F control.

1: Speedless Vector Control 1 (Comparing with the speed vector control 2, the mode is more suitable to control the induction motor below 160KW,

supporting the speed and torque control)

Speedless sensor vector control run mode, mainly used to velocity control, torque control in the application site which require high control performance. To get better control performance, we need to set up motor parameter group F15 according to the motor nameplate details, and doing the self-learning to motor parameter. One VFD can only drive one motor in vector control mode, and VFD power need match up with motor, normally one class less or more of the VFD power than motor is allowed.

2: with speed sensor vector control (support the speed and torque control)

When choose the closed-loop vector control mode, the AC motor should be installed with an encoder, and the inverter should be installed with the same type of the encoder. It can be used on the high-accuracy speed control & torque control application. One inverter only can drive one AC motor, like Paper-make machine, cranes, and elevator.

When using the closed-loop control, including setting motor parameter (F15 group), we should also set the encoder parameter group (F16),and the Extended Port (F00.19) parameter.

F00.25	Monitor parameter 2 selection	Range : 0~65	2
---------------	--------------------------------------	---------------------	----------

When user choose EN-LED2 keypad , under monitoring mode we can use F00.25 parameter to modify monitoring content of keypad digital display (LED2).

When user choose EN-LCD1 or EN-LCD2 keypad, under monitoring mode we can use F00.25 parameter to change monitoring content of below LED.

For monitoring content of F00.25 parameter, please refer to description of F00.01

F00.26	Busbar voltage adjustment	Range : 0.900~1.100	1.000
---------------	----------------------------------	----------------------------	--------------

We can use this parameter to adjust the busbar voltage; to make the inverter bus voltage is accordingly to the exact figures.

F00.27	Parameter copying and language selection	Range: units digit: 0~2 tens digit: 0~2	00
---------------	-------------------------------------------------	----------------------------------------------------	-----------

Units digit: language selection. (Only valid for LCD keypad)

0: Chinese

1: English

2: Reserve

Tens digit: parameter upload and download (valid for LCD and digital potentiometer keypad)

0: No action

1: Parameter upload

2: Parameter download

7.2 Basic Run Function Parameter Group:F01

F01.00	Main frequency input channel selection	Range: 0~14	0
---------------	-----------------------------------------------	--------------------	----------

Total 15 types input channel for selection to chose inverter input channel of the main provide frequency,among 11~14 are reserve channel,currentlly there is no corresponding function.

0:Operation keyboard digital setup. When main frequency setup initial value to F01.01: modify F01.01 parameter to change main setting frequency with operation keyboard: or with $\textcircled{\wedge}$, $\textcircled{\vee}$ button to modify the value of F01.01

1:AI1 analog setup. Main frequency setup confirmed by AI1 analog voltage/ current, input range: 0~10V (AI1 jumper wire selection V side)or 4~20mA(AI1 jumper wire selection A side).

2:AI2 analog setup. Main frequency setup confirmed by AI2 analog voltage/current, input range: -10~10V (AI2 jumper wire selection V side)or 4~20mA(AI2 jumper wire selection A side).

3:Terminal UP/DOWN adjusting setup. When main frequency initial value is parameter F01.01, through terminal UP/DOWN function to adjust the main setting frequency. Terminal function setup into 16(frequency increase progressively (UP))or 17(frequency decrease progressively control(DOWN)).

4:Communication provide. Main frequency provide by selection communication mode.

5:EAI1 analog setup. When extension analog input EAI1 is valid,main frequency confirmed by EAI1 analog voltage/current,input range:-10~10V(EAI1 jumper wire selection V side)or 4~ 20mA(EAI1 jumper wire selection A side). Relevant extension card selection needed to use this setup function.

6:EAI2 analog setup. when extension analog input EAI2 valid,main frequency setup by EAI2 analog voltage / current,input range:-10~10V(EAI2 jumper wire selection V side) or 4~ 20mA(EAI2 jumper wire selection A side). Relevant extension card selection needed to use this setup function.

7:High speed pulse setup. main frequency setup by frequency signal of terminal pulse(only X8 input),input pulse specification:voltage range 15~30V; frequency range 0.00~50.00KHz.

8:Terminal pulse setup. main frequency setup by pulse width signal of terminal pulse(only X8 input),input pulse specification:voltage range 15~30V; pulse width range 0.1~999.9ms.

9:Terminal encoder setup.main frequency setup by terminal encoder pulse(only combination input by X1 and X2) and frequency velocity set by parameter F08.30.

10~14: Reserved



Note

Analog provide is positive and negative polarity control, its prior to command direction control: when main frequency provide is AI2, EAI1, EAI2: and setup provide to be -10~10V, run direction confirmed by analog provide signal polarity completely, when PID run is valid, run direction confirmed by PID error polarity and parameter F11.21 completely.



Excerpt terminal encoder provide (F01.00=9), main and auxiliary provide channel cannot be set into the same frequency source: if they are the same: then panel would be light (ALM) and display A-51.

F01.01	Main frequency digital setup	Range: 0.00Hz~upper limit frequency	50.00Hz
--------	------------------------------	-------------------------------------	---------

When F01.00=0,3 or 4, F01.01 is the initial value of main frequency.

F01.02	Main frequency digital control	Range: 00~11	00
--------	--------------------------------	--------------	----

Units digit: power down reserve setup

0: Main frequency power down reserve. When main frequency channel provide is valid, power down in run status, current main frequency of run frequency is recorded in parameter F01.01.

1: Main frequency power down no reserve.

Tens digit: halt reserve setup

0: Halt main frequency hold. When main frequency channel provide is valid, current run frequency only recorded after halt.

1: Halt main frequency recovery F01.01. main setting frequency recorded in software is recovery to value of parameter F01.01 after halt.



Note

Only when parameter F01.00=0, 3, 4, it can be valid, after power-fail or Stop storage function both are valid, stop the machine first, it also can serve.

F01.03	Auxiliary frequency input channel select	Range : 0~20	20
--------	------------------------------------------	--------------	----

VFD auxiliary provides frequency input channel has 21 input channels for selection, for them 11~20 are Reserved channels, and currently there is no relevant function:

0:Keyboard operation digital setup. When auxiliary frequency setup initial value is parameter F01.04, modify parameter F01.04 to change auxiliary setting frequency: or with \wedge , \vee button modify the value of parameter F01.04

1:AI1 analog setup. Auxiliary frequency setup confirmed by AI1 analog voltage /current, input range: 0~10V (AI1 jumper wire selection V side)or 4~20mA(AI1 jumper wire A side).

2:AI2 analog setup. Auxiliary frequency setup confirmed by AI2 analog voltage/current, input range: -10~10V (AI2 jumper wire selection V side) or 4~20mA (AI2 jumper wire selection A side).

3:Terminal UP/DOWN adjusting setup. Auxiliary frequency initial value is parameter F01.04, through terminal UP/DOWN function to adjust auxiliary setting frequency.

4:communication setting. The initial value of auxiliary frequency is for F01.04, it will determine by F05.00 of the communication setting.

5:EAI1 analog setup. When extension analog input EAI1 is valid, auxiliary frequency setup confirmed by EAI1 analog voltage/current, input range: -10~10V (EAI1 jumper wire selection V side)or 4~20mA(EAI1 jumper wire selection A side).

6:EAI2 analog setup. When extension analog input EAI2 is valid, auxiliary frequency setup confirmed by EAI2 analog voltage/current, input range: -10~10V (EAI2 jumper wire selection V side) or 4~20mA (EAI2 jumper wire selection A side).

7:High speed pulse setup. Auxiliary frequency setup by frequency signal of terminal pulse (only X8 input), input pulse specification: voltage range 5~30V; frequency range 0.00~50.00 KHz.

8:Terminal pulse width setup. Auxiliary frequency setup by pulse width signal of terminal pulse (only X8 input), input pulse specification: voltage range 15~30V; pulse width range 0.1~999.9ms.

9:Terminal encoder provide. Auxiliary frequency setup by terminal encoder pulse (only X3 or X4 input), 0.01Hz is a fixed adjusting precision.

10~20: Reserved.



Note

Analog provide is positive and negative polarity control,its prior to command direction control: when auxiliary frequency provide is AI2,EAI1,EAI2 ,and setup provide is to be -10~10V,run direction confirmed by analog provide signal polarity completely.



Except terminal encoder provide(F01.03=9),main and auxiliary provide channel cannot setup to the same frequency source,when they are the same,then panel light(ALM),and A-51 display.

F01.04	Auxiliary frequency digital setup	Range:0.00Hz~upper limit frequency	0.00Hz
---------------	------------------------------------------	-------------------------------------------	---------------

When F01.03=0, 3 or 4, F01.04 is the initial frequency value of auxiliary frequency.

F01.05	Auxiliary frequency digital control	Range: 00~11	11
---------------	--------------------------------------------	---------------------	-----------

Units digit: power down reserve setup

0:Auxiliary frequency power down reserve. When auxiliary frequency channel provide is valid and power down at run mode, the current auxiliary setting frequency reserve in parameter F01.04.

1:Auxiliary frequency power down no reserve.

tens digit: halt reserve setup

0:Halt auxiliary frequency hold. When auxiliary frequency channel provide is valid, recording current run frequency only after halt.

1:Halt auxiliary frequency recovery parameter F01.04 .auxiliary setting frequency in software recording is recovered the value of parameter F01.04 after halt.



Note

Only when F01.03=0,3,4 is valid.

F01.06	Main and auxiliary provide calculating setup	Range: 0~7	0
---------------	-----------------------------------------------------	-------------------	----------

This parameter is to select frequency provide channel: and through the complex of main frequency source and auxiliary frequency source to achieve frequency provide.

0:Main frequency. Complex frequency of current is main frequency.

1: Auxiliary frequency. Complex frequency of current is auxiliary frequency.

2: Plus(polarity oppose of complex and main frequency,complex frequency is zero).

3:Minus(polarity oppose of complex and auxiliary frequency,complex frequency is zero).

4:Multiplication(polarity opposed of main and auxiliary frequency:

complex frequency is zero).

5:Max(the max frequency of main and auxiliary absolute value).

6:Min(the min frequency of main and auxiliary absolute value).

7:Selection no-zero value(auxiliary is not negative,main frequency prior;auxiliary is negative,complex frequency is zero)



Note

1.The initial polarity of main and auxiliary frequency cannot change after main and auxiliary operation.

2.When main and auxiliary frequency channel are complex value,and both setup into power down reserve: parameter F01.01 and F01.04 reserve separately the changed part of main frequency and auxiliary frequency in the complex frequency when power down.

F01.07	Auxiliary frequency provide coefficient	Range : 0.00~10.00	1.00
---------------	------------------------------------------------	---------------------------	-------------

Parameter F01.07 can adjust auxiliary provide frequency gain.

F01.08	Coefficient after complex of main and auxiliary frequency	Range: 0.00~10.00	1.00
---------------	------------------------------------------------------------------	--------------------------	-------------

This parameter is to setup frequency flexibly and calculates the gain of complex setting frequency by main and auxiliary frequency.

F01.09	Auxiliary frequency range selection	Range: 0, 1	0
---------------	--------------------------------------------	--------------------	----------

0:Relative high limit frequency. Auxiliary frequency setup range: 0.00Hz~high limit frequency×F01.10.

1:Relative main frequency. Auxiliary frequency setup range: 0.00Hz~main frequency×F01.10.

F01.10	Auxiliary frequency source scope	Range: 0.00~1.00	1.00
---------------	-----------------------------------------	-------------------------	-------------

This parameter cooperate with F01.09 define the scope of auxiliary provide frequency. Auxiliary provide frequency high limit value is restrained by the frequency selected by parameter F01.09 through parameter F01.10 gain calculation.

F01.11	Upper limit frequency	Range: lower limit frequency~600.00Hz	50.00Hz
---------------	------------------------------	----------------------------------------------	----------------

This parameter's max setting frequency of all run modes should be modification carefully according to the motor nameplate details.

F01.12	Low limit frequency	Range: 0.00Hz~upper limit frequency	0.40Hz
F01.13	Low limit frequency run mode	Range : 0~3	2

F01.14	Sleep run hysteresis frequency	Range: 0.01Hz~upper limit frequency	0.01Hz
---------------	---------------------------------------	--------------------------------------------	---------------

0: As low limit frequency run.

1: As setting frequency run.

2: As zero frequency run.

3: Sleep: PWM clocked at sleep mode.

When actual setting frequency lower than low limit frequency, low limit frequency run mode selection 0, then drive run at low limit frequency; low limit frequency run mode selection 1, drive continuously run according to setting frequency; low limit frequency run mode selection 2, drive continuously low output frequency and run at zero frequency; low limit frequency run mode selection 3, immediately clock the output and display frequency decline slowly to zero, when provide value over low limit frequency, drive restart to accelerate run from 0Hz to provide value after through F01.14 stagnant loop.



Note

When F01.13=3: this parameter can finish sleep function to achieve energy saving run and avoid drive to start frequently at threshold value through width of return difference.

F01.15	Run command channel selection	Range: 0~2	0
---------------	--------------------------------------	-------------------	----------

0: Operation keyboard run control. Start and stop with

1: Terminal run command control. Terminal X1 is forward (FWD), X2 is reverse (REV) during the function code X1~X8 setup. Other terminal can also be regarded as for/rev input terminal.

2: Communication runs command control. Start and stop with communication mode.

1. Drive can change run command channel through switch of multi-function key, terminal command channel in halt and run, carefully modify command channel after confirm in site the permission to run command channel modification. After the command channel modification: keyboard  button setup valid or not by parameter F00.15.

2. After run command channel modification, frequency channel can be defined by parameter F18.00, F18.01, F18.02 .or defined by parameter F01.00, F01.03, F01.06 and multi-function terminal.



F01.16	Run direction setup	Range: units digit: 0,1 tens digit: 0~2	00
---------------	----------------------------	----------------------------------------------------	-----------

Units digit: Keyboard command for/rev setup (only valid to keyboard inching command)

0: Forward.

1: Reverse.

Tens digit: for/rev forbid (suitable for all command channel, not include inching function)

0: For/rev available.

1: Reverse not available (imposing on reverse, stop as the halt mode).

2: Forward not available (imposing on forward, stop as the halt mode).

F01.17	Acceleration time 1	Range: 1~60000	Depend on type
F01.18	Deceleration time 1	Range:1~60000	Depend on type

Acceleration time is interval accelerate from zero frequency to high limit frequency, deceleration time is the interval decelerate from high limit frequency to zero frequency. The unit defined by F01.19. Example: F01.17=100, F01.19=1, acceleration time 1 is 10.0 seconds.



Note

1.EN500/EN600 series drive defines 15 acceleration and deceleration time, only acceleration and deceleration time 1 defined here, acceleration and deceleration 2~15 defined in parameter F04.16~F04.43.

2.acceleration and deceleration 1~15 select time unit through parameter F1.19, factory default unit is 0.1 second.

F01.19	Accelerate/decelerate time unit	Range: 0~2	1
---------------	----------------------------------------	-------------------	----------

This function can define acceleration and deceleration time unit.

0:0.01s

1:0.1s

2:1s



Note

1.The function is valid to all acceleration and deceleration except for inching run.

2.Advise to select 0.1s as the time unit.

F01.20	Accelerate/decelerate mode selection	Range: 0, 1	0
---------------	---------------------------------------------	--------------------	----------

0:Line acc/dece mode. Output frequency raises or decline as the constant slope, as fig.7-1.

1: S curve acc/dece mode. Output frequency raise or decline as the S curve: as fig.7-2.

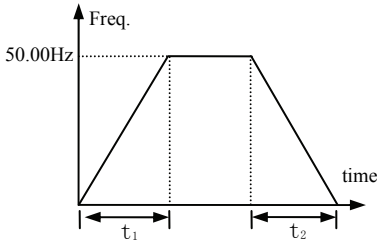

Fig. 7-1 Line acc/dece

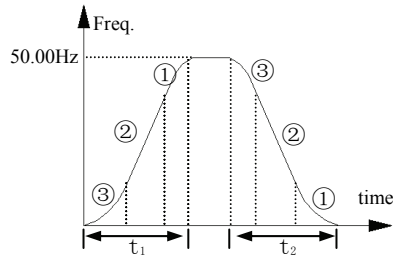

Fig. 7-2 S curve acc/dece

F01.21	S curve acceleration initiation segment time	Range: 10.0%~50.0%	20.0%
F01.22	S curve acceleration up segment time	Range: 10.0%~70.0%	60.0%
F01.23	S curve deceleration initiation segment time	Range: 10.0%~50.0%	20.0%
F01.24	S curve deceleration up segment time	Range: 10.0%~70.0%	60.0%

F01.21~F01.24 select S curve acceleration and deceleration mode(F01.20=1)valid only under acceleration and deceleration, and $F01.21+F01.22 \leq 90\%$, $F01.23+F01.24 \leq 90\%$.

S curve starts interval time as fig.7-2③, output frequency changed slope increase slowly from zero.

S curve up interval time as fig.7-2②, output frequency changed slope is constant.

S curve ends interval time as fig.7-2①, output frequency changed slope decrease slowly to zero.



S curve acc/dece mode is suitable for the start and stop of elevator, conveyor belt, transport and transfer load so on.

F01.25	Keyboard jog run frequency	Range:0.00Hz~upper limit frequency	5.00Hz
F01.26	Terminal jog run frequency	Range:0.00Hz~upper limit frequency	5.00Hz
F01.27	Jog interval time	Range: 0.0~100.0s	0.0s
F01.28	Jog acceleration time	Range: 0.0~6000.0s	20.0s
F01.29	Jog deceleration time	Range: 0.0~6000.0s	20.0s

F01.25, F1.26 defines keyboard jog and terminal jog run frequency, when jog run: accelerate as the zero frequency, and not effect by the start mode defined by parameter F02.00. When jog command revocation, stop as setting halt mode, when input another command during the deceleration, accelerate or decelerate according to the current frequency.

F1.27 defies valid command interval time at continuously jog. When jog command invalid, the time restart jog command is short than jog interval time, jog command ignore here.

F1.28, F1.29 defines jog run acceleration and deceleration time, fixed unit is 1s.

7.3 Start, stop, forward/reverse, brake function parameter group: F02

F02.00	Start running mode	Range: 0~2	0
---------------	---------------------------	-------------------	----------

0: Start from starting frequency. After receiving start command by setting F02.01 delay time, the inverter starts after setting F02.02 starting frequency and F02.03 starting frequency duration.

1: First brake, and then start from starting frequency. First brake the current from DC and then from time (F02.04, F02.05), and then start after setting starting frequency and starting frequency duration set by F02.03.

2: Speed tracking start. This mode can be supported by the entire motor control model at the present.



Note

1. Start-up mode 0: It is suggested to use Start-up mode 0 for general purpose applications and for general drive synchronous motor.

2. Start-up mode 1: Suitable for small inertia load, for example, forward and reverse occurs when the motor is not driven.

3. Start-up mode 2: Suitable for the starting of large inertia load before stopping stably. Generally this mode is used when restarting after power failure, fault self-recovery and other functions. The following points need to be noticed when this Start-up mode is used:

3.1 When the inverter stops freely, restart the inverter after a few seconds. If over-current fault occurs when starting, please extend the F02.08 time.

3.2 Do not modify the set frequency when the inverter starts in slow down process.

4. When torque model is valid, we suggest use the start mode 2.

F02.01	Starting delay time	Range: 0.0~60.0s	0.0s
---------------	----------------------------	-------------------------	-------------

Starting delay time refers to the waiting time before the inverter is started after receiving running command.

F02.02	Starting frequency	Range: 0.0~10.00Hz	0.00Hz
F02.03	Starting frequency duration time	Range: 0.0~60.0s	0.0s

Starting frequency refers to the initial frequency when the inverter is started, as shown in Fig. 7-3 fs; starting frequency holding time refers to consecutive running time during which the inverter runs at the starting frequency, as shown in Fig. 7-3 t₁.

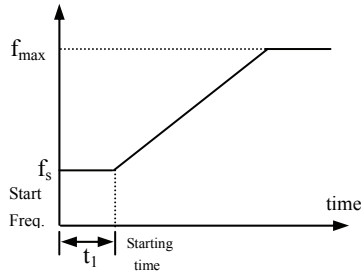

Fig. 7-3 Starting frequency and starting time



Note

Starting frequency is not limited by lower limit frequency.

F02.04	DC braking current when starting	Range: 0.0 ~ 100.0% (G type inverter rated current)	30.0%
F02.05	DC braking time when starting	Range: 0.0 ~ 30.0s	0.0s

When F02.00=1, F02.04, F02.05 valid, and stop mode is deceleration stop, as shown in Fig. 7-4.

The setting of starting DC braking current is with respect to the percentage of inverter rated output current. When starting DC braking time is 0.0 second, no DC braking process.

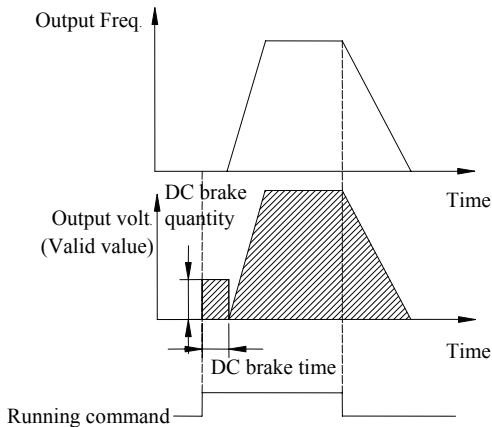

Fig. 7-4 Starting mode 1 description

F02.06	Speed track starting frequency selection	Range: 0~2	2
---------------	-------------------------------------------------	-------------------	----------

0: Current setting frequency.

1: Running frequency before power down.

2: Speed track auxiliary starting frequency.

Select frequency closed to the current running frequency of the motor so as to track the current running revolving speed of the motor. For example, when current running frequency is closed to current setting frequency, then select 0 and start to search from current setting frequency.

F02.07	Speed track auxiliary starting frequency	Range:0.00Hz~upper limit frequency	10.00Hz
---------------	-------------------------------------------------	-------------------------------------------	----------------

This parameter defines when 2 is selected in F02.06 parameter, the starting searching frequency when revolving track is started.

F02.08	Speed track starting waiting time	Range: 0.00~10.00s	0.10s
---------------	------------------------------------------	---------------------------	--------------

When 2 is selected in F02.00, if the inverter checks that the running command is valid, the revolving speed is searched after the time defined by F2.08.

F02.09	Speed track current control coefficient	Range: 1~20	2
---------------	------------------------------------------------	--------------------	----------

This parameter define the speed search process tracking current, the bigger of the value , the faster it can track.

F02.10	Speed track searching speed time	Range: 0.1~30.0	4.00
---------------	-----------------------------------------	------------------------	-------------

This parameter can be modified to improve speed track time.

On SVC control, the minimum unit of speed tracking for search speed time is 0.1s;

On V/F control, the minimum unit of speed tracking for search speed time is 1s;



Note

1. F02.06~F02.09 parameter only can be started on the speed variator, the start is valid.

2.F02.10 parameter can be used for both V/F model and SVC model .

F02.11	Stop mode	Range: 0~2	0
---------------	------------------	-------------------	----------

0: Deceleration stop. After receiving stop command, the inverter reduces output frequency gradually according to the set deceleration time, the inverter stops when frequency is 0.

1: Free stop. After receiving stop command, the inverter stops output

immediately, and the load stops freely according to mechanical inertia.

2: Deceleration + DC braking stop. After receiving stop command, the inverter reduces output frequency gradually according to the set deceleration time. When reaching F02.14 starting frequency of stop braking, After F02.15 defines DC braking waiting time, the inverter starts DC braking, as shown in Fig. 7-5.

F02.12	Deceleration stop holding frequency	Range: 0.00Hz~upper limiting frequency	0.00Hz
F02.13	Deceleration stop holding time	Range: 0.00~10.00s	0.00s

The parameters F02.12 and F02.13 define inverter's deceleration stop holding function. When the frequency reaches set value of F02.12 in deceleration, it stops deceleration, and maintains the set time of F02.13, and enters deceleration state. This parameter is only valid for stop mode 0.

F02.14	Stop DC braking starting frequency	Range: 0.00~15.00Hz	0.00Hz
F02.15	Sop DC braking waiting time	Range:0.00~30.00s	0.00s
F02.16	Stop DC braking current	Range: 0.0~100.0% (G type machine rated current)	0.0%
F02.17	Stop DC braking time	Range: 0.0~30.0s	0.0s
F02.18	Stop auxiliary braking current	Range: 0.0~100.0% (G type machine rated current)	0.0%
F02.19	Stop auxiliary braking time	Range: 0.0~100.0s	0.0s

F02.14 ~ F02.19 parameter defines the current and duration inputting to the motor in the stop DC braking state. If F02.17, F02.19 or F02.14 parameter is 0.0s, then no DC braking process.

Auxiliary DC brake means when the inverter stops DC brake is finished give the second stage DC braking. Role in some special circumstances require rapid braking, and stop long time in the state of DC braking, but to prevent motor heat circumstances.

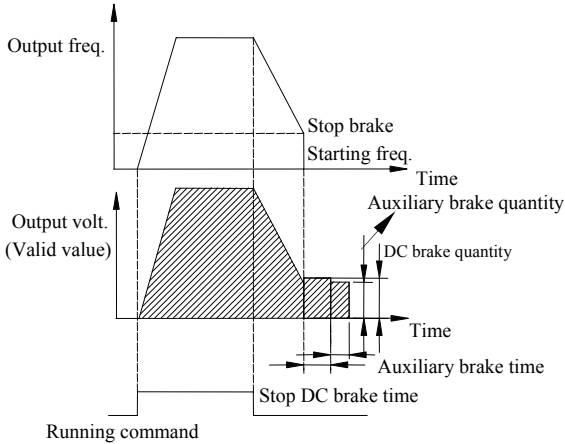

Fig. 7-5 Deceleration stop + DC braking

F02.20	Forward/reverse dead zone time	Range:0.0~3600.0s	0.0s
F02.21	Forward/reverse switching mode	Range: 0, 1	0

0: Over zero switchover

1: Over starting frequency switchover

Forward/reverse dead zone time refers to the process in which the inverter operates from forward to reverse or from reverse to forward. After output frequency reaches the defined frequency in switchover mode, entering in to the transition time, as shown in Fig. 7-6 t_1 , within transition time t_1 , output frequency is 0Hz.

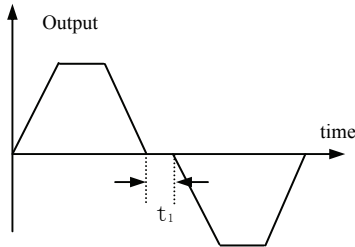

Fig. 7-6 Forward/reverse dead zone time

F02.22	Energy consumption braking selection	Range: 0, 1	0
---------------	---------------------------------------------	--------------------	----------

0: No energy consumption braking.

1: Energy consumption braking.



Note

1.Please set the function parameter correctly according to the actual use condition. Otherwise, control feature will be affected. Before starting this function, make sure the inverter has built-in brake unit and brake resistor.

2.When the inverter is below 15KW, this parameter value is 1; when inverter is up 15KW,this parameter value is 0.

F02.23	Energy consumption braking voltage	Range:115.0~145.0% (rated busbar voltage)	125.0%
F02.24	Energy consumption braking use rate	Range:0.0~100.0%	100.0%

Energy consumption braking function is only valid for built-in brake unit. F02.23 defines energy consumption braking busbar voltage threshold value, F02.24 parameter adjusts duty ratio brake unit. The higher the brake use rate is, the greater the brake unit duty ratio is, and the more apparent the brake effect is, but when fluctuation of the brake process busbar voltage is more apparent, user needs to select proper parameter based on brake resistor and brake power.

F02.25	Encryption time	Range:0~65535h	0
---------------	------------------------	-----------------------	----------

When F02.25>1, the encryption time is available. When the running time exceed the time defined by F02.25, the inverter will stop and it will restart after decode.

F02.26	Reserved		
---------------	-----------------	--	--

7.4 V/F control parameter group: F03

F03.00	V/F curve set	Range: 0~4	0
---------------	----------------------	-------------------	----------

0: Constant torque curve.

1: Degression torque curve 1.

2: Degression torque curve 2.

3: Degression torque curve 3.

4: V/F curve setting (V/F frequency and voltage cannot be 0 or Max. value).

This function code defines EN600 flexible V/F setting mode to satisfy different load characteristics. 4 kinds of fixed curves and one customized curve can be selected according to definition of F03.00.

When F3.00=0, V/F curve is Constant torque curve feature, as shown in Fig. 7-7a curve 0.

When F03.00=1, V/F curve is 2.0 order power degressive torque characteristic, as shown in Fig. 7-7a curve 3.

When F03.00=2, V/F curve is 1.7 order power degressive torque characteristic, as shown in Fig. 7-7a curve 2.

When F03.00=3, V/F curve is 1.2 order power degressive torque characteristic, as shown in Fig. 7-7a curve 1.

User can choose 1, 2, 3 V/F curve running mode according to load characteristic to reach better energy-saving effect when the inverter drives degressive torque load such as blower and water pump etc.

When F03.00=4, user can set V/F curve by setting F03.04 ~ F03.11 parameter.

As shown in Fig. 7-7b, V/F curve can be defined freely by setting (V1, F1), (V2, F2), (V3, F3), (V4, F4) to meet special load environment.

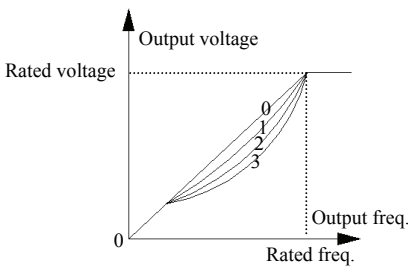
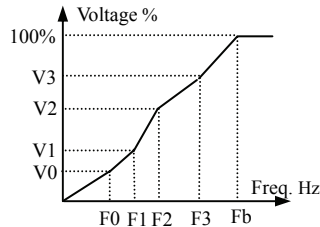

Fig. 7-7 a V/F curve



V0~V3: The 1st-4th voltage percentage of multi section V/F
 F0~F3: The 1st-4th frequency points of multi section V/F
 Fb: Rated frequency

b User-setting V/F curve

F03.01	Torque boost mode	Range: 0, 1	0
---------------	--------------------------	--------------------	----------

0: Manual boost. Torque boost voltage is totally decided by parameter F03.02, whose feature is that the boost voltage is fixed, but magnetic saturation of the motor is occurs often to the light-load.

$$\text{Boost voltage} = \frac{\text{F03.02}}{100} \times \text{motor rated voltage}$$

1: Auto torque boost. Torque boost voltage changes when the stator current of the motor changes, the greater the stator current is, magnetic saturation boost voltage is.

$$\text{Boost voltage} = \frac{\text{F03.02}}{100} \times \text{motor rated voltage} \times \frac{\text{Inverter output current}}{2 \times \text{inverter rated current}}$$

F03.02	Torque boost	Range: 0.0~12.0%	Depend on type
F03.03	Torque boost cut-off frequency	Range:0.0~100.0% (motor rated frequency)	100.0%

Improving inverter low torque characteristic, the output voltage can be compensated

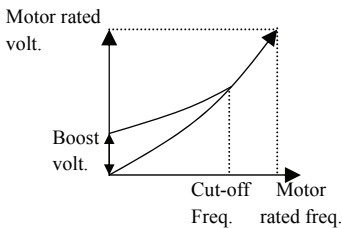

a Degression torque curve Torque boost

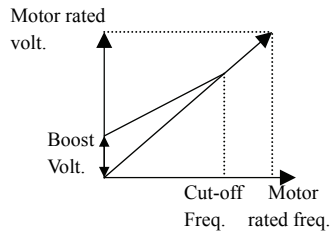

b Constant torque curve Torque boost

Fig. 7-8 Torque boost



Note

1.F03.02 for increasing torque setting to this parameter can cause motor heating or over current protection.

2.When driving synchronous machine ,User is advised to adopt manual torque boost and adjust V/F curve according to motor parameter and usage occasion when driving synchronous motor.

F03.04	V/F frequency value 0	Range: 0.00~V/F frequency value1	10.00Hz
F03.05	V/F voltage value 0	Range:0.00~V/F voltage value1	20.00%
F03.06	V/F frequency value1	Range: V/F frequency value 0~V/F frequency value2	20.00Hz
F03.07	V/F voltage value1	Range: V/F voltage value0~V/F voltage value2	40.00%
F03.08	V/F frequency value2	Range: V/F frequency value1~V/F frequency value3	25.00Hz
F03.09	V/F voltage value2	Range: V/F voltage value1~V/F voltage value3	50.00%
F03.10	V/F frequency value3	Range: V/F frequency value2~upper limiting frequency	40.00Hz
F03.11	V/F voltage value3	Range: V/F voltage value2~100.00%(motor rated voltage)	80.00%

F03.04 ~ F03.11 defines multi-step V/F curve. Note that 4 voltage points and frequency points relationship shall be satisfied: $V_0 < V_1 < V_2 < V_3$, $F_0 < F_1 < F_2 < F_3$, for details, please refer to Fig. 7-8b.

If the voltage at low frequency is set too high, motor overheat or even over burning may cause, over current protection may occur to the inverter.

F03.12	V/F oscillation suppression factor	Range: 0~255	10
---------------	-------------------------------------------	---------------------	-----------

Under V/F control, this parameter can be set properly to prevent motor vibration of the motor. When the inverter operates at low frequency without load, the greater the motor power is, the greater the vibration of motor will be. This parameter can be increased to restrain the vibration of motor. When carrier freq. is smaller, this parameter can be adjusted lower to reduce vibration.

7.5 Auxiliary running parameter group: F04

F04.00	Jump freq. 1	Range: 0.00Hz~upper limiting frequency	0.00Hz
F04.01	Jump freq. 1 range	Range: 0.00Hz~upper limiting frequency	0.00Hz
F04.02	Jump freq. 2	Range: 0.00Hz~upper limiting frequency	0.00Hz
F04.03	Jump freq. 2 range	Range: 0.00Hz~upper limiting frequency	0.00Hz
F04.04	Jump freq. 3	Range: 0.00Hz~upper limiting frequency	0.00Hz
F04.05	Jump freq. 3 range	Range: 0.00Hz~upper limiting frequency	0.00Hz

F04.00 ~ F04.05 is set to keep inverter's output frequency away from resonance frequency of mechanical load. Inverter setting frequency can jump around some frequency point according to mode as shown in Fig. 7-9, 3 jumping ranges can be defined at most.

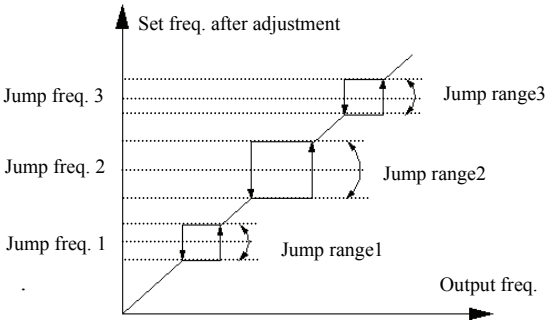

Fig. 7-9 Jump freq. and range

F04.06	Slip freq. gain	Range: 0.0~300.0%	0.0%
F04.07	Slip compensation limit	Range: 0.0~250.0%	100.0%
F04.08	Slip compensation time constant	Range: 0.1~25.0s	2.0s

This function can adjust output frequency properly as the load varies to compensate slip frequency of the asynchronous motor dynamically, so that control motor speed is in constant value. If acting with automatic torque boost function, better low speed moment characteristic can be obtained. As shown in Fig.7-10.

Slip compensation range = Slip compensation limit (F04.06)× Rated slip .

Rated slip = $F15.03 \times 60 / N_p - F15.04$.

N_p is motor polarity.

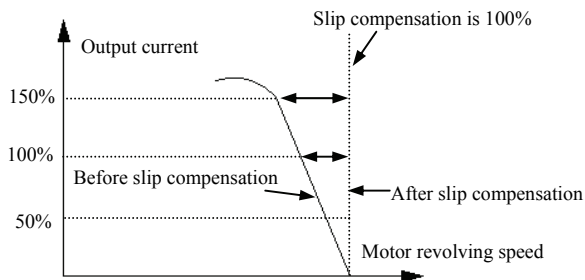

Fig. 7-10 Slip freq. Compensation

F04.09	Carrier frequency	Range: 0.5~16.0K	Depend on type
---------------	--------------------------	-------------------------	-----------------------

Carrier freq. mainly affects motor noise and heat loss when running. Relationship among carrier freq, motor noise, and leak current is as follows:

When carrier freq. goes up (↑), the motor noise is reduced (↓), leakage current of the motor is increased (↑), and the interference is increased (↑);

When carrier freq. goes down (↓), the motor noise is increased (↑), leakage current of the motor is decreased (↓), and the interference is decreased (↓).

When the ambient temperature is high, and the motor load is heavy, reduce the carrier freq. properly to reduce thermal loss to the inverter.

Table7-1 model and Carrier freq. relationship

Model	Max. Carrier freq.	Factory Default
0.4KW~1.5KW	16KHz	6KHz
2.2KW~11KW	16KHz	5KHz
15KW~55KW	8KHz	4KHz
75~200KW	6KHz	2KHz
220KW above	4KHz	2KHz



Note

- 1.To get better control characteristic, it is suggested that the ratio of max. running frequency between carrier frequency and inverter be not smaller than 36.
- 2.Error exists in current displayed value when carrier frequency is small.

F04.10	PWM optimized adjustment	Range: units digit: 0,1 tens digit: 0,1 hundreds digit: 0,1 thousands digit: 0,1	0110
---------------	---------------------------------	-----------------------------------------------------------------------------------------------------	-------------

Units digit: Carrier freq. is adjusted automatically according to temperature

0: Banned.

1: Allowed.

Carrier frequency changes based on temperature, which refers to inverter check that the radiator temperature is relatively high, it automatically reduces carrier freq., so as to reduce inverter temperature rise. When radiator temperature is relatively low, carrier freq. gradually restores to set value. This function can reduce inverter overheat alarm.

Digit: low speed carrier freq. limit mode

0: No limit.

1: Limit. Limit carrier wave at low speed, improve stability performance of revolving speed at low speed.

Hundreds digit: carrier wave modulation system

0: 3 phase modulation.

1: 2 phase and 3 phase modulation.

Thousands digit: Asynchronous modulation, synchronization mode (valid under V/F control)

0: Asynchronous modulation.

1: Synchronous modulation (under 85Hz: Asynchronous modulation).

1. When units digit is set as 1, after reaching overheat warning alarm point, carrier wave will decrease to 1.5KHz; when the temperature decrease to 5°C lower than overheat warning alarm point, carrier freq. will automatically rise to the set carrier freq.
2. Synchronous modulation, it means that carrier freq. changes when output frequency changes, it guarantees that the ratio (carrier ratio) between the two does not change, generally used when output frequency is high, conducive to input voltage quality. When output frequency is low(85Hz or below, generally no need of synchronous modulation), so at this time carrier freq. and output frequency ratio is relatively high, advantages of asynchronous modulation are more apparent. When operating frequency is higher than 85Hz, Synchronous modulation is valid, frequency lower than this is fixed with asynchronous modulation mode.



Note

F04.11	AVR function	Range : 0~2	0
---------------	---------------------	--------------------	----------

AVR namely automatic voltage regulation function, it indicates that the inverter can output constant voltage by AVR function when the inverter inputs voltage fluctuates.

0: No action

1: Action all the time

2: No action only during deceleration



Note

1. When input voltage is higher than rated value, under normal situation, F04.11=1 shall be set. F02.11= 0 namely inverter is in deceleration stop, motor deceleration time short time running current will be greater. But the motor decrease speed placidly with small run current and long Dec time if choose AVR action all the time.

2. When motor system vibration occurs due to AVR function, set F04.11= 0, namely AVR function is invalid.

3. This function is valid in V/F control mode.

F04.12	Reserved		
---------------	-----------------	--	--

F04.13	Automatic energy saving operation	Range: 0, 1	0
---------------	------------------------------------------	--------------------	----------

0: No action

1: Action

To reach better energy-saving effect, automatic energy-saving purpose can be obtained by checking load current.

When motor runs with no-load or light-load, energy-saving can be realized by checking load current, and properly adjusting input voltage. Auto energy-saving operation is mainly used in applications like stable load and revolving speed.



Note

1. This function is generally used in load like blower and water pump.

2. This function is valid only in V/F mode.

F04.14	Acceleration time 2 and 1 switchover frequency	Range: 0.00Hz~upper limit frequency	0.00Hz
F04.15	Deceleration time 2 and 1 switchover frequency	Range: 0.00Hz~upper limit frequency	0.00Hz

This function is used in the process of the inverter running, and we should adopted the acceleration time and deceleration for different applications.

During the acceleration process, if the frequency is lower than F04.14, we choose acceleration time 2, if the running frequency is bigger than F04.14, we choose acceleration time 1, during the deceleration process, if the running frequency is bigger than F04.15, then we choose deceleration time 1 , if the running frequency is lower than F14.05, then we choose deceleration time 2.



Note

When using terminal for choose the deceleration time,F04.14, F04.15 function is invalid.

F04.16	Acceleration time 2	Range: 1~60000	200
F04.17	Deceleration time 2	Range: 1~60000	200
F04.18	Acceleration time 3	Range: 1~60000	200
F04.19	Deceleration time 3	Range: 1~60000	200
F04.20	Acceleration time 4	Range: 1~60000	200
F04.21	Deceleration time 4	Range: 1~60000	200
F04.22	Acceleration time 5	Range: 1~60000	200
F04.23	Deceleration time 5	Range: 1~60000	200
F04.24	Acceleration time 6	Range: 1~60000	200
F04.25	Deceleration time 6	Range: 1~60000	200
F04.26	Acceleration time 7	Range: 1~60000	200
F04.27	Deceleration time 7	Range: 1~60000	200
F04.28	Acceleration time 8	Range: 1~60000	200
F04.29	Deceleration time 8	Range: 1~60000	200
F04.30	Acceleration time 9	Range: 1~60000	200
F04.31	Deceleration time 9	Range: 1~60000	200
F04.32	Acceleration time 10	Range: 1~60000	200
F04.33	Deceleration time 10	Range: 1~60000	200

F04.34	Acceleration time 11	Range: 1~60000	200
F04.35	Deceleration time 11	Range: 1~60000	200
F04.36	Acceleration time 12	Range: 1~60000	200
F04.37	Deceleration time 12	Range: 1~60000	200
F04.38	Acceleration time 13	Range: 1~60000	200
F04.39	Deceleration time 13	Range: 1~60000	200
F04.40	Acceleration time 14	Range: 1~60000	200
F04.41	Deceleration time 14	Range: 1~60000	200
F04.42	Acceleration time 15	Range: 1~60000	200
F04.43	Deceleration time 15	Range: 1~60000	200

EN500/EN600 defines 15 kinds of acceleration/deceleration time, select acceleration/deceleration time 1 ~ 15 during the inverter running by different combinations of control terminal. Please refer to the definitions of acceleration/deceleration time terminal function in F08.18 ~ F08.25. Cooperating with simple PLC function can also realize each step of PLC adopting different acceleration/deceleration time to complete specific requirements.

The time unit of acceleration/deceleration time 2 ~ 15 above is the same as that of acceleration/deceleration time 1, all are decided by F01.19 parameter of acceleration/deceleration time unit.



Note

Acceleration/deceleration time 1 is defined in F01.17 and F01.18.

7.6 Communication control parameter group: F05

F05.00	Protocol selection	Range: 0~6	0
---------------	---------------------------	-------------------	----------

0: Modbus protocol .

1: Reserved.

2: Profibus protocol, external expansion card needs to be purchased if needed.

3: CANlink protocol, external expansion card needs to be purchased if needed.

4: CANopen protocol, external expansion card needs to be purchased if needed.

5: Free protocol 1. Can realize the revision of all EN600 function parameters

6: Free protocol 2. Can only realize the revision of part EN600 function parameters

F05.01	Baud rate configuration	Range: units digit: 0~8 tens digit: 0~3 hundreds digit: 0~6	005
---------------	--------------------------------	----------------------------------------------------------------------------	------------

F05.01 is for choosing communication baud rate when using different communication modules.

Units digit: Free protocol and Modbus Baud rate selection

0:300BPS

1:600BPS

2:1200BPS

3:2400BPS

4:4800BPS

5:9600BPS

6:19200BPS

7:38400BPS

8:57600BPS

Tens digit: Profibus_DP Baud rate selection

0: 115200BPS

1: 208300BPS

2: 256000BPS

3: 512000BPS

Hundreds digit: CanLink and CANopen Baud rate selection

0:20K

1:50K

2:100K

3:125K
4:250K
5:500K
6:1M

F05.02	Data format	Range: units digit:0~5 tens digit :0~3 hundreds digit: 0,1	000
---------------	--------------------	---------------------------------------------------------------------------	------------

Units digit: Free protocol and Modbus protocol data format

0: 1-8-1 format, no parity, RTU. 1 for start bit, 8 for data bits, 1 for stop bit, no parity's RTU communication mode.

1: 1-8-1 format, even parity, RTU. 1 for start bit, 8 for data bits, 1 for stop bit, even parity's RTU communication mode.

2: 1-8-1 format, odd parity, RTU. 1 for start bit, 8 for data bits, 1 for stop bit, odd parity's RTU communication mode.

3: 1-7-1 format, no parity, ASCII. 1 for start bit, 7 data bits, 1 for stop bit, no parity's ASCII communication mode.

4: 1-7-1 format, even parity, ASCII. 1 for start bit, 7 data bits, 1 for stop bit, even parity's ASCII communication mode.

5: 1-7-1 format, odd parity, ASCII. 1 for start bit, 7 data bits, 1 for stop bit, odd parity's ASCII communication mode.

Tens digit: Profibus_DP protocol data format

0: PPO1communication format

1: PPO2communication format

2: PPO3communication format

3: PPO5communication format

Hundreds digit: Modbus agreement or free protocol response selection

Under the condition that Modbus or protocol agreement and the hundreds of F05.02 is 1, when slave sends mainframe the demand of running, frequency revise and hide parameter inside, the slave is without response to increase the slave response speed. But when mainframe reads inverter parameter, status or revises inverter any parameter, the hundreds of F05.02 would not influence the slave response.

F05.03	Local address	Range: 0~247	1
---------------	----------------------	---------------------	----------

During serial port communication, this function code is used to identify inverter's address.

Under free protocol communication, 00 is set and the inverter is master station, can be the Master-slave communication.

Under Modbus communication, 00 is broadcast address. When setting broadcast address, it can only receive and execute upper computer broadcast command,

while cannot respond to upper computer.

F05.04	Communication overtime checkout time	Range:0.0~1000.0s	0.0s
---------------	---------------------------------------------	--------------------------	-------------

When serial port communication fails and its continuous time exceed set value of this function code, the inverter judges it as communication failure.

The inverter would not detect serial port communication signal, namely this function ineffective when set value is 0.

F05.05	Communication error checkout time	Range: 0.0~1000.0s	0.0s
---------------	------------------------------------------	---------------------------	-------------

When serial port communication fails and its continuous time exceed set value of this function code, the inverter judges it as communication failure.

The inverter would not detect serial port communication signal, namely this function ineffective when set value is 0.

F05.06	Local response delay time	Range: 0~200ms (Modbus is valid)	5ms
---------------	----------------------------------	-----------------------------------------	------------

Local response delay time represents the time within which the inverter serial port receives and executes command from upper device and then responds to upper device.

F05.07	Main & sub inverter communication frequency setting percentage	Range: 0~500%	100%
---------------	---------------------------------------------------------------------------	----------------------	-------------

After setting this parameter proportion when frequency sent from main inverter, as the input source of communication frequency of sub inverter, one inverter can control multiple devices with different proportional frequency.



Note

This parameter is valid only when inverter is master slave station and the frequency given channel is communication given.

F05.08	Communication virtual input terminal enabled	Range: 00~FFH	00H
---------------	-----------------------------------------------------	----------------------	------------

- Bit0: CX1 virtual input terminal enabled
- Bit1: CX2 virtual input terminal enabled
- Bit2: CX3 virtual input terminal enabled
- Bit3: CX4 virtual input terminal enabled
- Bit4: CX5 virtual input terminal enabled
- Bit5: CX6 virtual input terminal enabled
- Bit6: CX7 virtual input terminal enabled
- Bit7: CX8 virtual input terminal enabled

F05.09	Communication virtual input terminal joining node	Range: 0,1	0
---------------	----------------------------------------------------------	-------------------	----------

0: Independent node. Communication virtual terminal function is only set in F05.10 ~ F05.17.

1: Terminal node. Communication virtual terminal function is only set in F08.18 ~ F08.25, regardless of X1 ~ X8 valid, or CX1 ~ CX8 valid all execute this setting function, X1 ~ X8 corresponds to CX1 ~ CX8.

F05.10	Communication virtual terminal CX1 function	Range: 0~90	0
F05.11	Communication virtual terminal CX2 function	Range: 0~90	0
F05.12	Communication virtual terminal CX3 function	Range: 0~90	0
F05.13	Communication virtual terminal CX4 function	Range: 0~90	0
F05.14	Communication virtual terminal CX5 function	Range: 0~90	0
F05.15	Communication virtual terminal CX6 function	Range: 0~90	0
F05.16	Communication virtual terminal CX7 function	Range: 0~90	0
F05.17	Communication virtual terminal CX8 function	Range: 0~90	0

Communication virtual terminal CX1 ~ CX8 function and terminal X1 ~ X8 function is different.



Note

The communication virtual terminal function is realized by setting the Modbus address and 1D09

F05.18	Input mapping application parameter 1	Range: F00.00~F26.xx	25.00
F05.19	Input mapping application parameter 2	Range: F00.00~F26.xx	25.00
F05.20	Input mapping application parameter 3	Range: F00.00~F26.xx	25.00
F05.21	Input mapping application parameter 4	Range: F00.00~F26.xx	25.00
F05.22	Input mapping application parameter 5	Range: F00.00~F26.xx	25.00
F05.23	Input mapping application parameter 6	Range: F00.00~F26.xx	25.00
F05.24	Input mapping application parameter 7	Range: F00.00~F26.xx	25.00

F05.25	Input mapping application parameter 8	Range: F00.00~F26.xx	25.00
F05.26	Input mapping application parameter 9	Range: F00.00~F26.xx	25.00
F05.27	Input mapping application parameter 10	Range: F00.00~F26.xx	25.00

Input parameter address mapping.

This parameter is used for mapping waiting for input. Integral part corresponds with group no. of the parameter, while decimal part corresponds with intra-class reference (parameter series no. within group parameter). For example: Setting F05.18=00.00 indicates that mapping F05.18=00.00 as input parameter1.



Note

1. xx represents function code.
2. F25.xx represents not mapping.
3. By this way, some incontinuity parameter can be together to read the data, and using the input mapping application parameter to increase the communication efficiency. For example, if reading F00.00, F01.10, F02.02 and F03.04, you can map the above-mentioned parameters to F05.18, F05.19, F05.20, F05.21 and F05.22. Under RTU communication mode, only 1 continuous reading 5 groups of parameter commands (01 03 05 12 00 05 24 D1) can read 5 groups of parameter values, thus improving communication efficiency.

F05.28 ~ F05.39	Reserved		
-----------------------	----------	--	--

7.7 Setting curve parameter group: F06

F06.00	Setting curve selection	Range: units digit: 0~2 tens digit: 0~2 hundreds digit: 0~2 thousands digit: 0~2	0000
---------------	--------------------------------	-----------------------------------------------------------------------------------------------------	-------------

Units digit: AI1 curve selection

0: curve 1.

1: curve 2.

2: curve 3.

Tens digit: AI2 curve selection

Same as units digit.

Hundreds digit: rapid pulse curve selection

Same as units digit.

Thousands digit: Pulse width setting curve selection

Same as units digit.

This function code tens digit, hundreds digit and thousands digit are used to select analog quantity input AI1, AI2, rapid pulse input and pulse width input signal setting curve. Curve 1 and 2 are 3 point curve, curve 3 is 4 point curve. User can select different curves for adjustment based on characteristic requirement of the input signal so as to realize specific input.

F06.01	Curve 1 min. setting	Range: 0.0% ~ curve 1 Inflexion setting	0.0%
F06.02	Corresponding physical quantity of curve 1 min. setting	Range: 0.0 ~ 100.0%	0.0%
F06.03	Curve 1 inflexion setting	Range: curve 1 min. setting ~ curve 1 Max. setting	50.0%
F06.04	Corresponding physical quantity of curve 1 inflexion setting	Range: 0.0 ~ 100.0%	50.0%
F06.05	Curve 1 Max. setting	Range: curve 1 inflexion setting ~100.0%	100.0%
F06.06	Corresponding physical quantity of curve 1 Max. setting	Range: 0.0 ~ 100.0%	100.0%
F06.07	Curve 2 min. setting	Range: 0.0% ~ curve 2 inflexion setting	0.0%
F06.08	Corresponding physical quantity of curve 2 min. setting	Range: 0.0 ~ 100.0%	0.0%
F06.09	Curve 2 inflexion setting	Range: curve 2 min. setting ~ curve 2 Max. setting	50.0%

F06.10	Corresponding physical quantity of curve 2 inflexion setting	Range: 0.0 ~ 100.0%	50.0%
F06.11	Curve 2 Max. setting	Range: curve 2 inflexion setting ~ 100.0%	100.0%
F06.12	Corresponding physical quantity of curve 2 Max. setting	Range: 0.0 ~ 100.0%	100.0%
F06.13	Curve 3 min. setting	Range: 0.0% ~ curve 3 inflexion 1 setting	0.0%
F06.14	Corresponding physical quantity of curve 3 min. setting	Range: 0.0 ~ 100.0%	0.0%
F06.15	Curve 3 inflexion 1 setting	Range: curve 3 min. setting ~ curve 3 inflexion 2 setting	30.0%
F06.16	Corresponding physical quantity of curve 3 inflexion 1 setting	Range: 0.0 ~ 100.0%	30.0%
F06.17	Curve 3 inflexion 2 setting	Range: curve 3 inflexion 1 setting ~ curve 3 Max. setting	60.0%
F06.18	Corresponding physical quantity of curve 3 inflexion 2 setting	Range: 0.0 ~ 100.0%	60.0%
F06.19	Curve 3 Max. setting	Range: curve 3 inflexion 1 setting ~100.0%	100.0%
F06.20	Corresponding physical quantity of curve 3 Max. setting	Range: 0.0 ~ 100.0%	100.0%

Take curve 1 as an example:

Parameter F06.01 ~ F06.06 is used to set analog quantity input voltage and its representative set value relationship. When analog quantity input voltage is greater than the set “Max. input”(F06.05), analog quantity voltage is calculated based on “Max. input”; similarly, When analog input voltage is smaller than the set “min. input”(F06.01), Set based on “curve lower than min. input setting selection”(F06.21), calculated by min. input or 0.0%.



Note

1. For function and usage of curve 2, please refer to curve 1 instruction.
2. Curve 3 function is similar to curve 1 and curve 2, but curve 1 and 2 are three-point straight line, while curve 3 is four-point curve, which can realize more flexible corresponding relationship.
3. The output positive/negative polarity of curve 1, 2, 3 is decided by the features of input analog signal. Curve will not change output positive/negative polarity.
4. As frequency setting, 100.0% setting corresponding physical quantity is upper limit frequency F01.11.

F06.21	Curve lower than min. input corresponding selection	Range: units digit: 0,1 tens digit: 0,1 hundreds digit: 0,1 thousands digit: 0,1 ten thousands digit: 0,1	11111
--------	-----------------------------------------------------	-----------------------------------------------------------------------------------------------------------------------	-------

Units digit: curve 1 setting

0: Corresponds to min. setting corresponding physical quantity.

1: 0.0% of the corresponding physical quantity.

Tens digit: curve 2 setting

Same as units digit.

Hundreds digit: curve 3 setting

Same as units digit.

Thousands digit: extended curve 1

Same as units digit.

Ten thousands digit: extended curve 2

Same as units digit.

This parameter is used to set, when curve's corresponding analog quantity input voltage is smaller than the min. setting, how to decide corresponding setting analog quantity.

For example, F06.21 units=0, when analog quantity input is lower than F06.01, this curve output F06.02 corresponding physical quantity value. If F06.21 units=1, when analog quantity input is lower than F06.01, this curve output is 0.

Take 0 ~ 10V A11 for setting frequency as an example: A11 selects curve 1, setting frequency and A11 relationship as shown in Fig. 7-11.

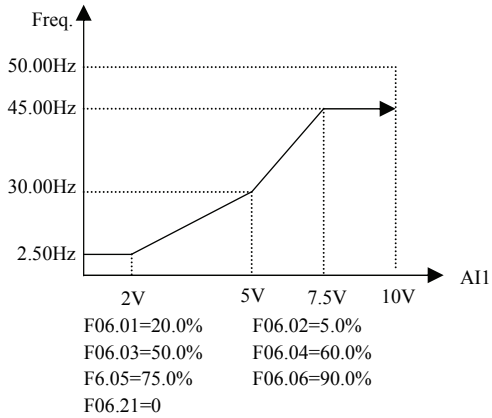

Fig. 7-11 AI1 selects curve 1 frequency setting

7.8 Analog quantity, Pulse input function parameter group: F07

F07.00	A11 input filter time	Range: 0.000~9.999s	0.050s
F07.01	A11 setting gain	Range: 0.000~9.999	1.004
F07.02	A11 setting bias	Range: 0.0~100.0%	0.5%

A11 input filter time, is used to set A11 software filter time. When field analog quantity is easily interrupted, increase filter time to make the analog quantity check stable, but when filter time is greater, the response time of analog quantity check is slower. Please set according to the actual situation.

A11 setting bias is indicated with Max. input (10V or 20mA) percentage, which is used to set up and down translation quantity of A11 analog input. Take voltage input, bias positive as an example, the adjustment relationship of setting bias and gain adjustment before and after adjustment is as follows:

Analog input A11 (after revise) = input gain(F07.01) × Analog input A11 (before revise) + setting bias (F07.02) × 10V

Taking current input and bias positive as an example, the adjustment relationship between gain adjustment and setting bias is as follows:

Analog input A11 (after revise) = input gain(F07.01) × Analog input A11 (before revise) + setting bias (F07.02) × 20mA

F07.03	A12 input filter time	Range: 0.000~9.999s	0.050s
F07.04	A12 setting gain	Range: 0.000~9.999	1.003
F07.05	A12 setting bias	Range: 0.0~100.0%	0.1%

Parameter F07.03 ~ F7.05 is used to set analog quantity input A12 filter time , gain and setting bias, For detail using method, please refer to analog quantity input A11. Take voltage input, bias positive as an example, the adjustment relationship between gain adjustment and setting bias is as follows:

Analog input A12 (after revise) = input gain(F07.04) × Analog input A12 (before revise) + setting bias (F07.05) × 10V

Taking current input and bias positive as an example, the adjustment relationship between gain adjustment and setting bias is as follows:

Analog input A12 (after revise) = input gain(F07.04) × Analog input A12 (before revise) + setting bias (F07.05) × 20mA

F07.06	Analog setting bias polarity	Range: units digit: 0,1 tens digit: 0,1	01
---------------	-------------------------------------	----------------------------------------------------	-----------

Units digit: A11 setting bias polarity

0: Positive polarity.

1: Negative polarity.

Tens digit: AI2 setting bias polarity

0: Positive polarity.

1: Negative polarity.

Parameter F07.06 is used to set analog quantity AI1 and when AI2 counts the polarity of bias. Take voltage input as an example, when F07.06 units are set as 0:
 Analog input AI1(after revise) = input gain(F07.01)×Analog input AI1(before revise)+ Setting bias(F07.02)×10V

When F7.06 units are set as 1:

Analog input AI1(after revise) = input gain(F07.01)×Analog input AI1(before revise)− Setting bias(F07.02)×10V

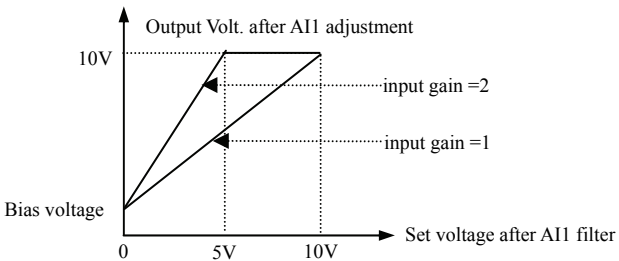

Fig. 7-12 AI1 adjustment

F07.07	Pulse input filter time	Range: 0.000~9.999s	0.000s
F07.08	Pulse input gain	Range: 0.000~9.999	1.000
F07.09	Pulse input Max. frequency	Range: 0.01~50.00KHz	10.00KHz

F07.07, F07.08 parameter defines filter time and gain when frequency channel selection terminal pulse is set. When setting filter time, Please be noted that the longer the filter time is, the slower the change rate of output frequency is. So set filter time properly according to the actual situation. Pulse width gain is for impulse quantity of current input impulse terminal.

F7.09 parameter defines frequency input range when frequency setting channel selection terminal pulse is set. When actual input frequency is greater than the set Max. frequency, deal with it according to Max. frequency.

F07.10	Pulse width input filter time	Range: 0.000~9.999s	0.000s
F07.11	Pulse width input gain	Range: 0.000~9.999	1.000
F07.12	Pulse width input logic setting	Range: 0,1	0

F07.13	Pulse width Max. input width	Range: 0.1~999.9ms	100.0ms
---------------	-------------------------------------	---------------------------	----------------

F07.10, F07.11 parameter defines filter time and gain when frequency channel selection terminal pulse width is set. When setting filter time, Please be noted that when the Max. pulse width set in F07.13 is smaller, the filter time is not suggested to be set too long, otherwise the response time of output frequency will be very slow. Pulse width gain is for impulse width duty cycle of current impulse width input terminal

0: Positive logic.

1: Negative logic.

F07.12 defines valid level of digital quantity input X8 channel input pulse when frequency channel selection terminal pulse width is set. The applications shall go with double polarity working state of X input terminal.

F07.13 parameter defines the width range of input valid pulse when frequency setting channel selection terminal pulse width is set.

F07.14	Reserved		
F07.15	Reserved		
F07.16	Reserved		
F07.17	Reserved		

7.9 On-off input function parameter group: F08

F08.00	Input terminal positive and negative logic setting	Range: 0000~FFFF	0000
---------------	-----------------------------------------------------------	-------------------------	-------------

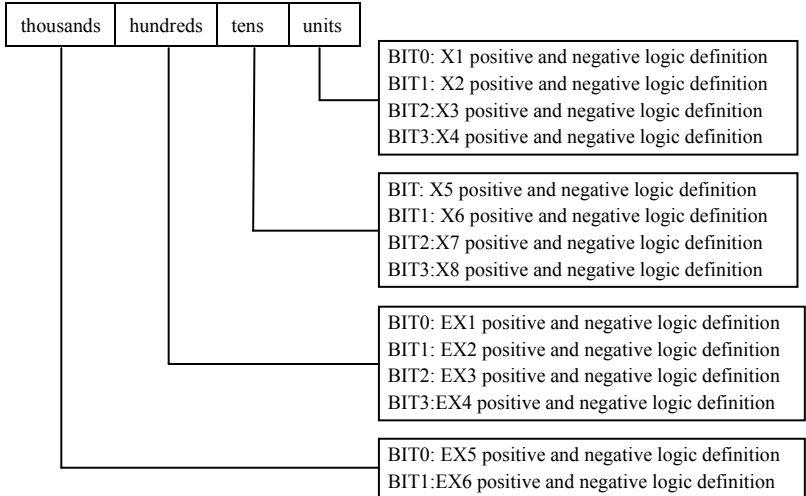

The setting of this parameter is finally converted to binary setting, relationship between binary setting and hexadecimal is as shown in table 7-2.

Table 7-2 Relationship between binary setting and bit displayed value

Binary setting				Hexadecimal (bit displayed value)
BI3	BIT2	BIT1	BIT0	
0	0	0	0	0
0	0	0	1	1
0	0	1	0	2
0	0	1	1	3
0	1	0	0	4
0	1	0	1	5
0	1	1	0	6
0	1	1	1	7
1	0	0	0	8
1	0	0	1	9
1	0	1	0	A
1	0	1	1	B
1	1	0	0	C
1	1	0	1	D

1	1	1	0	E
1	1	1	1	F

Bit refers to units, tens, hundreds or thousands displayed in operation panel.

F08.00 parameter defines valid logic state of Xi input terminal:

Positive logic: Xi terminal and corresponding common port closed valid, opened invalid;

Negative logic: Xi terminal and corresponding common port closed invalid, opened valid;

When BIT selects 0, it indicates positive logic; 1 indicates negative logic. Proper setting of this parameter can realize correct logic input without changing terminal wiring.

F08.01	Input terminal filter time	Range: 0.000~1.000s	0.010s
---------------	-----------------------------------	----------------------------	---------------

F08.01 parameter sets filter time of input terminal check. When input terminal state is changed, the terminal state change is valid only when the set filter time is unchanged. Otherwise, it will remain the last state, thus effectively reduce malfunction caused by interruption. The group C monitor state is for the state of the disposed parameter. When demand terminal as the high speed function, low down the value of this parameter is needed in case losing the signal.

F08.02	X1 Input terminal closed time	Range: 0.00~99.99s	0.00s
F08.03	X1 Input terminal opened time	Range: 0.00~99.99s	0.00s
F08.04	X2 Input terminal closed time	Range: 0.00~99.99s	0.00s
F08.05	X2 Input terminal opened time	Range: 0.00~99.99s	0.00s
F08.06	X3 Input terminal closed time	Range: 0.00~99.99s	0.00s
F08.07	X3 Input terminal opened time	Range: 0.00~99.99s	0.00s
F08.08	X4 Input terminal closed time	Range: 0.00~99.99s	0.00s
F08.09	X4 Input terminal opened time	Range: 0.00~99.99s	0.00s
F08.10	X5 Input terminal closed time	Range: 0.00~99.99s	0.00s
F08.11	X5 Input terminal opened time	Range: 0.00~99.99s	0.00s
F08.12	X6 Input terminal closed time	Range: 0.00~99.99s	0.00s
F08.13	X6 Input terminal opened time	Range: 0.00~99.99s	0.00s
F08.14	X7 Input terminal closed time	Range: 0.00~99.99s	0.00s
F08.15	X7 Input terminal opened time	Range: 0.00~99.99s	0.00s
F08.16	X8 Input terminal closed time	Range: 0.00~99.99s	0.00s

F08.17	X8 Input terminal opened time	Range: 0.00~99.99s	0.00s
---------------	--------------------------------------	---------------------------	--------------

F08.02 ~ F08.17 parameter defines the corresponding delay time of Xi input terminal from closed to opened or opened to closed so as to meet user's multiple requirements. This parameter does not affect the monitor value of input terminal state. You can revise the parameter to control the filtering when the interruption is strong.

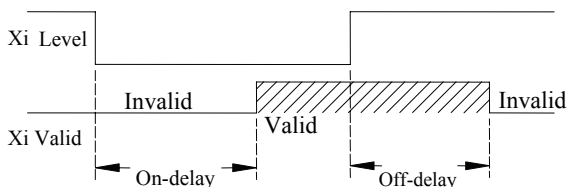

Fig. 7-13 closed and opened delay

F08.18	Input terminal X1 function selection	Range: 0~96	1
F08.19	Input terminal X2 function selection	Range: 0~96	2
F08.20	Input terminal X3 function selection	Range: 0~96	0
F08.21	Input terminal X4 function selection	Range: 0~96	0
F08.22	Input terminal X5 function selection	Range: 0~96	0
F08.23	Input terminal X6 function selection	Range: 0~96	0
F08.24	Input terminal X7 function selection	Range: 0~96	0
F08.25	Input terminal X8 function selection	Range: 0~96	0

Multi-functional input terminal X1 ~ X8 provides users with up to 95 selections, which can be selected based on actual applications. For details, please refer to parameter function Table 7-3.

Table 7-3 Multi-functional input selection function table

Content	Function	Content	Function
0	Leave control terminal unused	49	Auxiliary frequency reset
1	Forward running FWD terminal	50	Command switchover to panel
2	Reverse running REV terminal	51	Command switchover to terminal
3	External forward jogging control	52	Command switchover to communication
4	External reverse jogging control	53	Running command Channel selection terminal 1
5	Multi-step speed control terminal 1	54	Running command Channel selection terminal 2

7 Detailed function specification

6	Multi-step speed control terminal 2	55	Forward prohibited command (Stop according to the stop mode, invalid for jogging command)
7	Multi-step speed control terminal 3	56	Reverse prohibited command (Stop according to the stop mode, invalid for jogging command)
8	Multi-step speed control terminal 4	57	Swinging frequency input
9	Acceleration/deceleration time selection terminal 1	58	Resetting state of swinging frequency
10	Acceleration/deceleration time selection terminal 2	59	Interior counter reset end
11	Acceleration/deceleration time selection terminal 3	60	Interior counter input end
12	Acceleration/deceleration time selection terminal 4	61	Internal timer resetting
13	Main and auxiliary frequency operational rule selection terminal 1	62	Internal timer triggering
14	Main and auxiliary frequency operational rule selection terminal 2	63	Length count input
15	Main and auxiliary frequency operational rule selection terminal 3	64	Length reset
16	Frequency ascending command (UP)	65	Reset this operation time
17	Frequency descending command (DOWN)	66	Reserved
18	Frequency ascending/descending frequency resetting	67	Reserved
19	Multi-step closed loop terminal 1	68	Reserved
20	Multi-step closed loop terminal 2	69	Reserved
21	Multi-step closed loop terminal 3	70	Reserved
22	External equipment failure input	71	Reserved
23	External interruption input	72	Reserved
24	External resetting input	73	Reserved
25	Free stop input	74	Reserved
26	External stop instruction—Stop according to the stop mode	75	Reserved
27	stop DC braking input command DB	76	Reserved
28	inverter running prohibited—Stop according to the stop mode	77	Reserved
29	Acceleration/deceleration prohibited command	78	Reserved
30	Three-wire running control	79	Reserved
31	Process PID invalid	80	Reserved
32	Process PID stop	81	Reserved
33	Process PID integral holding	82	Reserved
34	Process PID integral resetting	83	Reserved
35	Process PID function negation (Closed loop adjustment feature negation)	84	Reserved
36	Simple PLC invalid	85	Reserved

37	Simple PLC halted	86	Reserved
38	Simple PLC stop state resetting	87	Reserved
39	Main frequency switchover to digit (keypad)	88	Reserved
40	Main frequency switchover to AI1	89	Reserved
41	Main frequency switchover to AI2	90	Reserved
42	Main frequency switchover to EA11	91	Reserved
43	Main frequency switchover to EA12	92	Pulse frequency input (X8 VALID)
44	Main frequency setting channel selection terminal 1	93	Pulse width PWM INPUT (X8 VALID)
45	Main frequency setting channel selection terminal 2	94	Reserved
46	Main frequency setting channel selection terminal 3	95	Reserved
47	Main frequency setting channel selection terminal 4	96	Reserved
48	Clear auxiliary frequency	-	-

Function introduction in Table 7-3 is as shown below:

1, 2: External command terminal. When running command channel is terminal running command, control inverter's forward and reverse by external terminal.

3, 4: External jogging command terminal. Set as any running command channel setting running command, control inverter's jogging forward and jogging reverse by external terminal.

5 ~ 8: Multi-step running terminal. By setting these functions' terminal ON/OFF combination, up to 15 multi-step running frequencies can be set. The increase and decrease time of each step corresponds to the each step time.

Table 7-4 Multi-step running selection table

K ₄	K ₃	K ₂	K ₁	Frequency setting
OFF	OFF	OFF	OFF	Other running frequencies
OFF	OFF	OFF	ON	Multi-step frequency 1
OFF	OFF	ON	OFF	Multi-step frequency 2
OFF	OFF	ON	ON	Multi-step frequency 3
OFF	ON	OFF	OFF	Multi-step frequency 4
OFF	ON	OFF	ON	Multi-step frequency 5
OFF	ON	ON	OFF	Multi-step frequency 6
OFF	ON	ON	ON	Multi-step frequency 7
ON	OFF	OFF	OFF	Multi-step frequency 8
ON	OFF	OFF	ON	Multi-step frequency 9
ON	OFF	ON	OFF	Multi-step frequency 10
ON	OFF	ON	ON	Multi-step frequency 11
ON	ON	OFF	OFF	Multi-step frequency 12
ON	ON	OFF	ON	Multi-step frequency 13

ON	ON	ON	OFF	Multi-step frequency 14
ON	ON	ON	ON	Multi-step frequency 15

When using multi-step speed to run and simple PLC to run, use multi-step speed frequency (F10.31 ~ F10.45) above, take multi-step speed running as an example: Define control terminal X1, X2, X3, X4:

When F08.18=5, F08.19=6, F08.20=7, F08.21= 8, X1, X2, X3, X4 are used to define multi-step speed running, as shown in Fig. 7-14.

Fig. 7-14 takes terminal running command channel as an example, X5 is set as forward terminal, X6 is reverse terminal, to control by forward and reverse running.

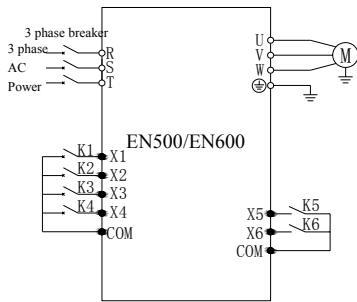

Fig. 7-14 Multi-step speed running wiring

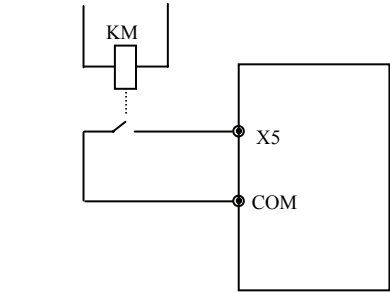

Fig. 7-15 Peripheral equipment fault Normally Open

9 ~ 12: Acceleration/deceleration time terminal selection. By ON/OFF of acceleration/deceleration time terminal, acceleration/deceleration time 1 ~ 15 can be selected. For details, see Table 7-5:

Table 7-5 Acceleration/deceleration time terminal selection

Acceleration/deceleration time selection terminal 4	Acceleration/deceleration time selection terminal 3	Acceleration/deceleration time selection terminal 2	Acceleration/deceleration time selection terminal 1	Acceleration/deceleration time selection
OFF	OFF	OFF	ON	Acceleration/deceleration time 1
OFF	OFF	ON	OFF	Acceleration/deceleration time 2
OFF	OFF	ON	ON	Acceleration/deceleration time 3
OFF	ON	OFF	OFF	Acceleration/deceleration time 4
OFF	ON	OFF	ON	Acceleration/deceleration time 5
OFF	ON	ON	OFF	Acceleration/deceleration time 6
OFF	ON	ON	ON	Acceleration/deceleration time 7
ON	OFF	OFF	OFF	Acceleration/deceleration time 8
ON	OFF	OFF	ON	Acceleration/deceleration time 9
ON	OFF	ON	OFF	Acceleration/deceleration time 10
ON	OFF	ON	ON	Acceleration/deceleration time 11
ON	ON	OFF	OFF	Acceleration/deceleration time 12

ON	ON	OFF	ON	Acceleration/deceleration time 13
ON	ON	ON	OFF	Acceleration/deceleration time 14
ON	ON	ON	ON	Acceleration/deceleration time 15

13 ~ 15: Main and auxiliary frequency operational rule selection terminal. By ON/OFF of frequency setting channel selection terminal 13, 14, and 15, 7 kinds of main and auxiliary frequency operational rules defined in F01.06 parameter can be realized. Switchover between main and auxiliary operational rule terminal is prior to function code F01.06 setting. For details, please see table 7-6:

Table 7-6 Selection table of terminal main and auxiliary frequency operational rule

Main and auxiliary operational rule selection terminal 3	Main and auxiliary operational rule selection terminal 2	Main and auxiliary operational rule selection terminal 1	Main and auxiliary operational rule selection
OFF	OFF	OFF	Decided by F01.06
OFF	OFF	ON	Synthesized frequency is sub-frequency
OFF	ON	OFF	Operation rule: addition
OFF	ON	ON	Operation rule: subtraction
ON	OFF	OFF	Operation rule: multiplication
ON	OFF	ON	Synthesized frequency is Max. value
ON	ON	OFF	Synthesized frequency is min. value
ON	ON	ON	Synthesized frequency is nonzero value

16, 17: Frequency ascending command UP/descending command DOWN. Realize frequency ascending or descending by control terminal, substitute operation keypad for remote control. Normal running F01.00 or F01.03 set as 3 is valid. Ascending/descending rate is set in F18.06 and F18.07.

18: Frequency ascending/descending frequency resetting.

When frequency setting is set as terminal UP/DOWN, this terminal can eliminate the set frequency value by terminal UP/DOWN.

19 ~ 21: Multi-step closed loop setting terminal. By ON/OFF of multi-step closed loop setting terminal, Table 7-7 Multi-step closed loop setting selection can be realized.

Table 7-7 Multi-step closed loop setting selection table

Multi-step closed loop setting selection terminal 3	Multi-step closed loop setting selection terminal 2	Multi-step closed loop setting selection terminal 1	Multi-step closed loop setting selection
OFF	OFF	OFF	Closed loop setting decided by F11.01
OFF	OFF	ON	Multi-step closed loop setting 1
OFF	ON	OFF	Multi-step closed loop

			setting 2
OFF	ON	ON	Multi-step closed loop setting 3
ON	OFF	OFF	Multi-step closed loop setting 4
ON	OFF	ON	Multi-step closed loop setting 5
ON	ON	OFF	Multi-step closed loop setting 6
ON	ON	ON	Multi-step closed loop setting 7

22: External equipment failure jump-in. with this terminal, peripheral equipment fault signal can be input, which is convenient for inverter to perform fault monitoring for peripheral equipment, as shown in Fig. 7-15.

23: External interruption input. When the inverter is running, after receiving external interruption signal, it blocks output, and runs with zero frequency. Once external interruption signal is released, and inverter running command is still valid, inverter auto revolving speed tracking starts, the inverter restarts.

24: External resetting input. When fault alarm occurs to the inverter, you can reset fault by this terminal. Its function and operation keypad  key function are in accordance.

25: Free stop input. The purpose of this function and free stop set in F02.11 is the same, but here it uses control terminal to realize, which is convenient for remote control.

26: External stop instruction. This command is effective for all running command channel, when this function terminal is effective, the inverter stops running according to mode set by F2.11.

27: Stop DC braking input command DB. Implement DC braking to the motor during stop by control terminal so as to realize emergency stop and accurate position of the motor. During deceleration stop, if this function terminal closed, when frequency is lower than the brake starting frequency F02.14, it will brake according to brake current defined in F02.16. It will not stop until terminal is opened.

28: Inverter running prohibited. The running inverter stops freely when this terminal is effective, and forbidden to start in waiting status. It is mainly applied to occasion needing safe linkage.

29: Acceleration/deceleration prohibited command. When this function is valid, keep the motor away from any external signal (except stop command), maintain current revolving speed running.



Note

This function is invalid in normal deceleration stop process.

30: Three-wire running control. Refer to F08.26 operating mode (Three-wire operating mode) function introduction.

31: Process PID invalid. Realize flexible switchover in low-level running mode under closed-loop running status.



Note

1. Switchover between closed-loop and low level running mode can be available only when the inverter runs in closed-loop mode (F11.00=1 or F12.00=1).
2. When switching to low-level running mode, start-stop control, direction and acceleration/deceleration time comply with relevant setting of running mode.

32: Process PID stop. Invalid when PID stops, when inverter maintains current output frequency, PID regulation of frequency source is no more performed.

33: Process PID integral holding. PID integral impact maintains, and will not regulate according to the output quantity.

34: Process PID integral resetting. When the terminal is valid, PID integral regulation function halts, but PID proportional control and differential control function are still valid.

35: Process PID function negation. When the terminal is valid, direction of PID effect and setting direction of F11.13 is opposite.

36: simple PLC invalid. Realize flexible switchover in low-level running mode under PLC running status.



Note

1. Switchover between PLC and low level running mode can be available only when the inverter runs in PLC mode (F10.00 unit's digit is not 0).
2. When switching to low-level running mode, start-stop control, direction and acceleration/deceleration time comply with relevant setting of running mode.

37: Simple PLC halted. It is to control the stop of running PLC, when the terminal is valid, the inverter runs at zero frequency, PLC running does not time; after invalid implementation, auto revolving speed tracking starts and keep on running PLC.

38: Simple PLC stop state resetting. Under stop status of PLC running mode, will clear PLC run step, runtime, run frequency etc. recorded when PLC running stops if this terminal is effective, please see F10 group function description.

39: Main frequency switchover to digital setting (keypad). The main frequency provision channel is switched to keypad digital provision when this terminal is valid (setting frequency by keypad up and down key).

40: Main frequency switchover to AI1. The main frequency provision channel is switched to analog quantity AI1 provision when this terminal is valid

41: Main frequency switchover to AI2. The main frequency provision channel is switched to analog quantity AI2 provision when this terminal is valid

42: Main frequency switchover to EA11. When extended analog quantity is valid, the main frequency provision channel is switched to extended analog quantity EA11 provision when this terminal is valid,

43: Main frequency switchover to EA12. When extended analog quantity is valid, , the main frequency provision channel switchover to extended analog quantity EA12 provision when this terminal is valid.

44 ~ 47: Main frequency setting channel selection terminal. By ON/OFF of selection terminal 1 ~ 4, Free selection of main frequency setting channel can be realized by terminal. The priority of main frequency setting channel selection terminal (terminal function 44 ~ 47) is higher than the main frequency switchover to (terminal function 41, 42, 43). For details, see table 7-8.

Table 7-8 Main frequency setting channel selection terminal

Channel selection terminal 4	Channel selection terminal 3	Channel selection terminal 2	Channel selection terminal 1	Main frequency setting channel selection terminal
OFF	OFF	OFF	ON	Operation keypad digital setting
OFF	OFF	ON	OFF	AI1 analog setting
OFF	OFF	ON	ON	AI2 analog setting
OFF	ON	OFF	OFF	Terminal UP/DOWN setting
OFF	ON	OFF	ON	Communication setting
OFF	ON	ON	OFF	EA11 analog setting (extended)
OFF	ON	ON	ON	EA12 analog setting (extended)
ON	OFF	OFF	OFF	rapid pulse setting (X8)
ON	OFF	OFF	ON	Pulse width setting (X8)
ON	OFF	ON	OFF	Terminal encoder setting (X1, X2)
ON	OFF	ON	ON	Keypad analog potentiometer setting (optional)
ON	ON	OFF	OFF	Reserved
ON	ON	OFF	ON	Reserved
ON	ON	ON	OFF	Reserved

48: Auxiliary frequency reset. Only valid for digit auxiliary frequency, when this function terminal is valid, reset auxiliary frequency setting quantity, setting frequency is completely decided by main frequency setting channel.

49: Command switchover to panel. When current command source is reset by terminal or communication, switchover between current command source and keypad command setting can be realized by this terminal.

50: Command switchover to terminal. When current command source is reset by keypad or communication, switchover between current command source and terminal command setting can be realized by this terminal.

51: Command switchover to communication. When current command source is reset by keypad or terminal, switchover between current command source and communication command setting can be realized by this terminal.

52, 53: Running command Channel selection terminal. For details, please refer to Table 7-9.

Table 7-9 Running command channel logic mode

Running command channel selection terminal 2	Running command channel selection terminal 1	Running command channel
OFF	OFF	Invalid
OFF	ON	Operation keypad running command channel
ON	OFF	Terminal running command channel
ON	ON	Communication running command channel

54: Forward prohibited command. Enable this terminal during the forward running process, and the inverter stops according to the stop mode. First enable this terminal, and then forward running enters zero frequency running status. Jogging running is not affected by this.

55: Reverse prohibited command. Function and “Forward prohibited command” are opposite.

56: Swinging frequency input. When the starting mode of swinging frequency is manual input, this terminal is valid, and swinging frequency function is valid. See F13 group function parameter instruction. When swinging frequency is set as manual input, this terminal is invalid, run with preset frequency of swinging frequency.

57: Resetting state of swinging frequency. When selecting swinging frequency function, no matter auto or manual input mode, closing this terminal will clear state information of swinging frequency memorized in the inverter. When opening this terminal, swinging frequency restarts. For details, please see F13 group function.

58: Interior counter reset end. Reset inverter built-in counter, and go with counter triggering signal input. For details, please see parameter F08.27, F08.28.

59: Interior counter input end. Interior counter’s counting pulse input port,

pulse max. frequency: 50.0KHz.

60: Interior timer reset end. Reset inverter built-in timer, goes with timer triggering-end signal input.

61: Interior timer triggering end. See parameter F08.29 function.

62: Length count input. Length counting input terminal, see fixed length function of F13 group parameter.

63: Length reset. When the terminal is valid, reset internal length value, see F13 fixed length function of parameter group.

64: Reset this operation time. When the terminal is valid, the running counting time of this inverter is reset, see timing running defined in F18 group.

65 ~ 90: Reserved

91: Pulse frequency input (X8 valid). Only valid for multi-functional input terminal X8, this function terminal accepts pulse signal as frequency setting, relationship between the input signal pulse frequency and setting frequency is as shown in F06 and F07 group parameter.

92: Pulse width PWM input (X8 valid). Only valid for multi-functional input terminal X8, this function terminal accepts PWM signal, check pulse width as frequency setting, relationship between input PWM Pulse width and setting frequency is as shown in F06 and F07 group parameter.

93~96:Reserved

F08.26	FWD/REV operating mode selection	Range: 0~4	0
---------------	-----------------------------------------	-------------------	----------

This parameter defines five different modes by controlling external terminal inverter running.

0: Two-wire control mode 1

K2	K1	Operating command
0	0	Stop
1	0	REV
0	1	FWD
1	1	Stop

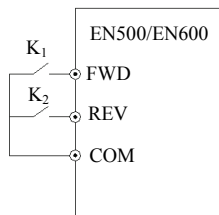
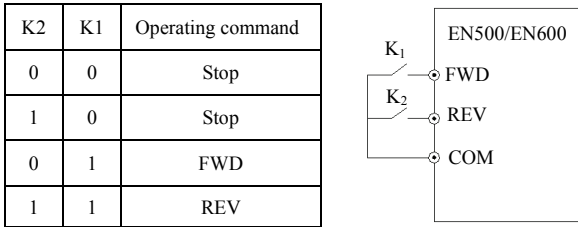
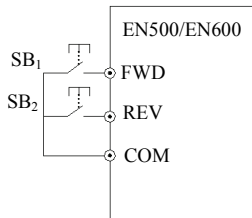

Fig. 7-16 Two-wire operating mode 1

1: Two-wire control mode 2**Fig. 7-17 Two-wire operating mode 2****2: Two-wire control mode 3 (monopulse control mode)**

Monopulse control is triggered-type control. After triggering SB1 once, it forwards runs. Retriggering SB1 once, it stops. Triggering SB1 once, it reversely runs. Retriggering SB2 once, it stops. If it is forward running, the inverter stops when triggering SB2 once. Retriggering SB1 once, it stops. If it is reverse running, the inverter stops when triggering SB1 once.

**Fig. 7-18 Two-wire control mode 3****3: Three-wire control mode 1**

Defines are as follows:

SB1: stop button

SB2: forward button

SB3: reverse button

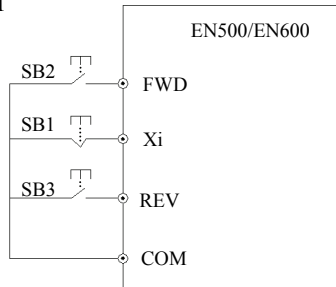
**Fig. 7-19 Three-wire operating mode 1**

X_i is $X_1 \sim X_8$'s Multi-functional Input terminal, at this moment, define its

corresponding terminal function as “Three-wire running control” function of No.30.

4: Three-wire control mode 2

SB1: stop button

SB2: run button

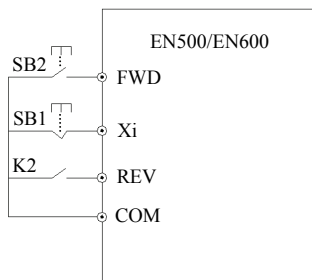

K2	Running direction selection
0	Forward
1	Reverse

Fig. 7-20 Three-wire operating mode 2

X_i is $X_1 \sim X_8$'s Multi-functional input terminal, At this moment, define its corresponding terminal function as “Three-wire running control” function of No. 30.

F08.27	Set internal count value to setting	Range: 0~65535	0
F08.28	Specify internal count to setting	Range: 0~65535	0

F08.27 and F08.28 are to additionally define functions of 30 and 31 in 7-10.

When X_i (Counting trigger signal input function terminal) output pulse reaches F08.27 defined value, Y_1 (Y_1 is set as internal count value final value to) outputs one indicating signal, as shown in Fig. 7-21, When X_i inputs the eighth pulse, Y_1 outputs one indicating signal. At this moment, F08.27=8.

When X_i (Counting trigger signal input function terminal) output pulse reaches F08.28 defined value, Y_2 (Y_2 is set as internal counter specified value to) outputs one indicating signal, until set count value arrives.

As shown in Fig. 7-21, when X_i inputs the fifth pulse, Y_2 starts outputting one indicating signal. Until set count value 8 arrives, F08.28=5. When specified count value is greater than set count value, specified count value Invalid.

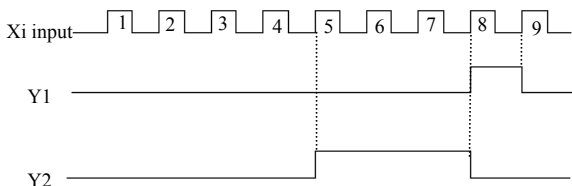

Fig. 7-21 set count value setting and specified count value setting

F08.29	Internal timer timing setting	Range: 0.1~6000.0s	60.0s
---------------	--------------------------------------	---------------------------	--------------

This parameter sets timing time of inverter internal timer, timer is triggered by external triggering terminal (Xi terminal function no. is 61), the timer starts timing upon receiving external triggering signal. After reaching timing time, Yi terminal outputs a breadth of 0.5s valid pulse signal. When internal timer clearing terminal is valid (Xi terminal function is set as 60), internal timer is reset.

F08.30	Terminal pulse encoder frequency rate	Range: 0.01~10.00Hz	1.00Hz
---------------	----------------------------------------------	----------------------------	---------------

This parameter defines main frequency regulation speed during terminal pulse encoder setting frequency (F01.00=9). Main frequency terminal encoder pulse input can only choose channel X1 and X2 combination; auxiliary frequency terminal encoder pulse input can only choose channel X3 and X4 combination, and the rate of the auxiliary frequency encoder frequency is the fixed rate.



Note

When 9 is selected in F01.00 and F01.03, X1~X4 can only be used as encoder frequency setting. Other terminal functions defined by F08.18~F08.21 are invalid.

F08.31	Reserved		
---------------	-----------------	--	--

7.10 Switch output function parameter group: F09

F09.00	Open-collector output terminal Y1 output setting	Range: 0~60	0
F09.01	Open-collector output terminal Y2 output setting	Range: 0~60	0
F09.02	Open-collector output terminal Y3 output setting	Range: 0~60	0
F09.03	Open-collector output terminal Y4 output setting	Range: 0~60	0
F09.04	Programmable relay output setting	Range: 0~60	22

Functions of the above parameters are used to select Y1 ~ Y4 and relay output terminals. Table 7-10 shows the functions of the above 4 terminals. One function can be selected repeatedly.

Open-collector (Yi) and high-speed pulse (DO) output share terminal Y4. Y4 terminal as the high-speed pulse function to be modified F00.22 thousands place to 1.

Table7-10 Output terminals function selection diagram

Setting	Function	Setting	Function
0	No output	31	Set count value reached
1	Frequency inverter running(RUN)	32	Designated count value reached
2	Frequency inverter Forward running	33	Shutdown time arrival of the running
3	Frequency inverter Reverse running	34	Time arrival of the running
4	Frequency inverter DC brake	35	Setup running time arrived
5	Frequency inverter Ready for operation(RDY)	36	Setup power-on time arrived
6	Shutdown command indicator	37	1st pump variable frequency
7	Zero current state	38	1st pump frequency
8	Over current state	39	2nd pump variable frequency
9	Current 1 arrived	40	2nd pump frequency
10	Current 2 arrived	41	Communication given
11	Frequency inverter Zero-frequency output	42	Reserved
12	Frequency arriving signal (FAR)	43	Reserved
13	Frequency level detection signal 1 (FDT1)	44	Reserved
14	Frequency level detection signal 2(FDT2)	45	Reserved
15	Output frequency arriving upper limit(FHL)	46	Reserved
16	Output frequency arriving lower limit(FLL)	47	Reserved
17	Frequency 1 arrived	48	Reserved
18	Frequency 2 arrived	49	Reserved
19	Frequency inverter overload pre- alarm signal(OL)	50	Reserved

20	Frequency inverter Low voltage lock-up signal(LU)	51	Reserved
21	External stopping command(EXT)	52	Reserved
22	Frequency inverter fault	53	Reserved
23	Frequency inverter warning	54	Reserved
24	Simple PLC operation running	55	Reserved
25	Completion of simple PLC operation	56	Reserved
26	Simple PLC cycle-running completed	57	Reserved
27	Simple PLC suspended	58	Reserved
28	Upper and lower limit of Wobble	59	Reserved
29	Setup length arrived	60	Reserved
30	Internal counter final value arrived	-	-

The instructions of the function output terminals listed in table 7-10 are as below:

0: The terminal function is idle.

1:Frequency inverter is running(RUN).The Drive is in the running state, output the indicator signal.

2. Frequency inverter is forward running. The Drive is in the forward running state, output the indicator signal.

3. Frequency inverter is reversed running. The Drive is in reversed running state, output the indicator signal.

4.Frequency inverter is DC braking. The Drive is in DC braking state, output the indicator signal.

5. Frequency inverter is ready to run. This signal being valid means that the Drive bus voltage is normal, the Drive is running and forbidding the terminal is invalid, it can accept a start command.

6. Shutdown command indicator. When the shutdown command is valid, output the indicator signal.

7. Zero current is detected. When detected the output meet the zero current state, output the indicator signal. Please refer to the instruction of F09.12and F09.13parameters for details.

8. Over current is detected. When the output current meet the over current detection conditions, output the indicator signal. Please refer to the instruction of F09.14and F09.15 parameters for details.

9. Current 1 arrived. When the output current reaches the detection conditions to meet the current 1, output the indicator signal. Please refer to the instruction of F09.16and F09.17 parameters for details.

10. Current 2 arrived. When the output current reaches the detection conditions to meet the current 2, output the indicator signal. Please refer to the instruction of F09.18and F09.19 parameters for details.

11. Frequency inverter Zero frequency output. Please refer to the function

instruction of F09.10 and F09.11.

12. Frequency arriving signal (FAR). Please refer to the function instruction of F09.05.

13. Frequency level detection signal 1 (FTD1). Please refer to the function instruction of F09.06, F09.07.

14. Frequency level detection signal 2 (FTD2). Please refer to the function instruction of F09.08, F09.09.

15. Output frequency reaches upper limit (FHL). When the running frequency reaches upper limit, the output is indicator signal.

16. Output frequency reaches lower limit (FHL). When the running frequency reaches lower limit, the output is indicator signal.

17. Frequency 1 arriving output. Please refer to the function instruction of F09.20, F09.21.

18. Frequency 2 arriving output. Please refer to the function instruction of F09.22, F09.23.

19. Frequency inverter overload pre-alarm signal. Frequency inverter output current exceeds F19.06 overload pre-alarm detection levels, and time is greater than F19.07 overload pre-alarm delay time, output the indicator signal.

20. Frequency inverter Low voltage lock-up signal (LU). When the frequency inverter is running, the DC bus voltage below the limit level, output indication signal.

21. External fault shutdown (EXT). When the frequency inverter appears external fault trip alarm (E-18), output indication signal.

22. Frequency inverter fault. When the frequency inverter detects fault, the output is indication signal.

23. Frequency inverter warning. When the frequency inverter detects alarm, the output is indication signal.

24. Simple PLC during operating. The simple PLC is enabled, and enter into operation state, output indication signal

25. Simple PLC stage operation completed. When the simple PLC stage operation is completed, output indication signal (single pulse signal, the width is 500ms).

26. Simple PLC ends after running a cycle. After the completion of a cycle of simple PLC, output indication signal (single pulse signal, the width is 500ms)

27. Simple PLC pause. When the simple PLC is running into the pause state, output is indication signal.

28. Wobble upper and lower limit. If the frequency fluctuation range calculated by center frequency exceeds the upper limit F01.11 or belows lower

limit F01.12 after selecting the wobble function, it will output indication signal, as shown in Figure 7-22.

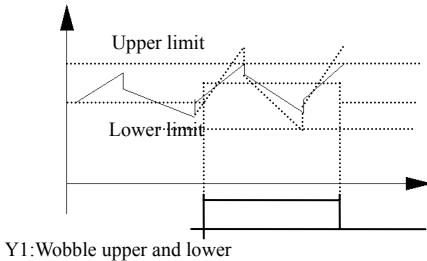

Fig.7-22 Wobble amplitude limit

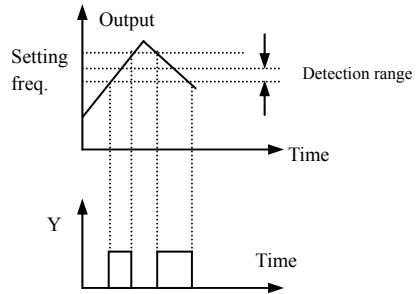

Fig.7-23 Freq. arrival signal output diagram

29. Setup length arrived. When detected the actual length exceeds a set value F13.08, output indication signal.

30. Internal counter final value arrived. Please refer to the function instruction of F08.27.

31. Internal counter specified value arrived. Please refer to the function instruction of F08.28.

32. Internal counter timing meter arrival. Please refer to the function instruction of F08.29.

33. Shutdown time arrival of the running. Frequency inverter runs longer than the setting time of F18.12, output indication signal.

34. Time arrival of the running. Frequency inverter runs longer than the setting time of F18.13, output indication signal.

35. Setup time arrived. Accumulated running time of the frequency inverter reaches the set accumulated running time (F18.10), output indication signal.

36. Setup power-on time arrived. Accumulated power on time of the frequency inverter reaches the set accumulated running time (F18.09), the output indication signal.

37: 1st pump variable frequency.

38: 1st pump frequency.

39: 2nd pump variable frequency.

40: 2nd pump frequency

When using Y1 ~ Y4 achieve two pumps constant pressure water supply, Y1 ~ Y4 functions are arranged in order of 37 to 40. Under constant pressure water supply mode, the four parameters must all set to this value, the terminal functions can be achieved

41: Communication given. In this moment the output of Yi is controlled by communication, Please refer to the related communication protocol for details.

42~60:Reserved

F09.05	Detection amplitude of frequency arrival(FAR)	Range: 0.00~50.00Hz	5.00Hz
---------------	------------------------------------------------------	----------------------------	---------------

This parameter is added in the definition of Table 7-10 on the 12th functions. As shown in Figure 7-23, when the inverter output frequency in the setting frequency of positive and negative detection width, output indication signal.

F09.06	FDT1(frequency level)level	Range: 0.00Hz~upper limit frequency	10.00Hz
F09.07	FDT1 lag	Range: 0.00~50.00Hz	1.00Hz
F09.08	FDT2(frequency level)level	Range: 0.00Hz~upper limit frequency	10.00Hz
F09.09	FDT2 lag	Range: 0.00~50.00Hz	1.00Hz

F09.06, F09.07 is in the definition of Table 7-10 on the 13th Functions, F09.08, F09.08 is in the definition of Table 7-10 on the 14th functions, take an example of 13th functions: When the output frequency exceeds a certain setting frequency (FDT1 level), output indicator Signal, until the output frequency drops below the certain frequency FDT1 frequency level (FDT1 level -FDT1 lag). As shown in Figure 7-24.

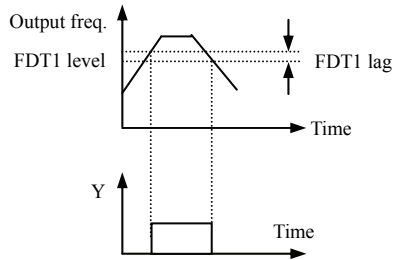

Fig.7-24 Freq. level detection diagram

F09.10	Zero-frequency signal detection value	Range: 0.00Hz~upper limit frequency	0.00Hz
F09.11	Zero-frequency backlash	Range: 0.00Hz~upper limit frequency	0.00Hz

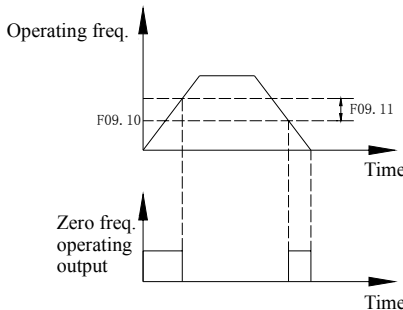

Fig.7-25 Zero-frequency signal detection

Parameter F09.10, F09.11 defines the zero frequency output control function. When the output frequency is within the zero-frequency signal detection range, if Yi output function selects 11, then the output of Yi is indication signal.

F09.12	Zero current detection amplitude	Range: 0.0~50.0%	0.0%
F09.13	Zero current detection time	Range: 0.00~60.00s	0.1s

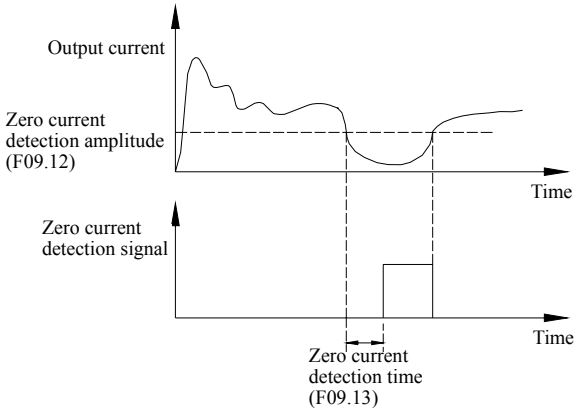

Fig.7-26 Zero current detection diagram

When the output current of the inverter is less than or equal to zero current detection level, and lasts longer than the zero current detection time, then the output of frequency inverter multifunction Yi is indication signal. Figure 7-26 is the schematic of zero current detection.

F09.14	Over-current detection value	Range: 0.0~250.0%	160.0%
F09.15	Over-current detection time	Range: 0.00~60.00s	0.00s

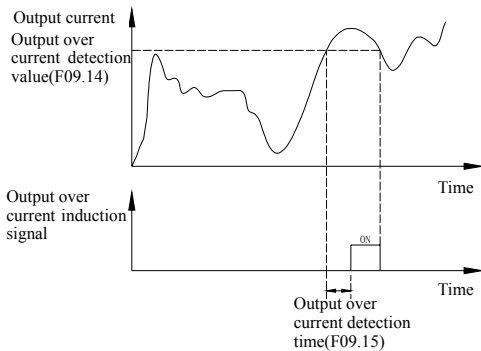

Fig.7-27 Output over-current detection diagram

When the output current of the inverter is greater than the over-current detection points, and lasted longer than the over-current detection time, frequency inverter multifunction Yi output indication signal, Figure 7-27 is the schematic of output over-current detection.

F09.16	Current 1 arriving the detection value	Range: 0.0~250.0%	100.0%
F09.17	Current 1 width	Range: 0.0~100.0%	0.0%
F09.18	Current 2 arriving the detection value	Range: 0.0~250.0%	100.0%
F09.19	Current 2 width	Range: 0.0~100.0%	0.0%

When the output current of frequency inverter is within the positive and negative detection width of setting current arrival, then the output of frequency inverter multifunction Yi is indication signal.

EN500/EN600 provides two current arrival and detection width parameters, table 7-28 is the function schematic diagram.

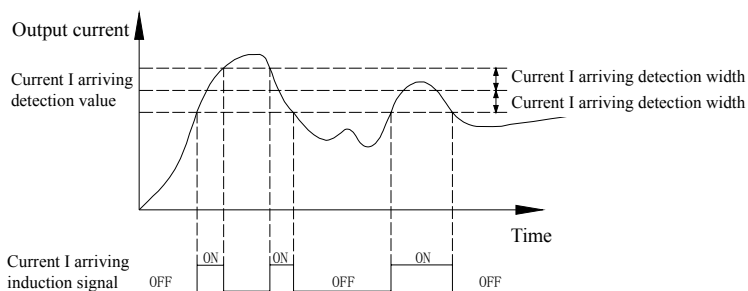

Fig.7-28 Current arriving detection diagram

F09.20	Frequency 1 arriving detection value	Range:0.00Hz~upper limit frequency	50.00Hz
F09.21	Frequency 1 arriving detection width	Range:0.00Hz~upper limit frequency	0.00Hz
F09.22	Frequency 2 arriving detection value	Range:0.00Hz~upper limit frequency	50.00Hz
F09.23	Frequency 2 arriving detection width	Range:0.00Hz~upper limit frequency	0.00Hz

When the output frequency of frequency inverter reaches detecting value of the positive and negative detecting width range, then the output of multifunctional Yi is indication signal.

EN500/EN600 provides two sets of frequency arrival detecting parameters, which have set frequency value and frequency detecting width respectively. Table 7-29

is the diagram of this function.

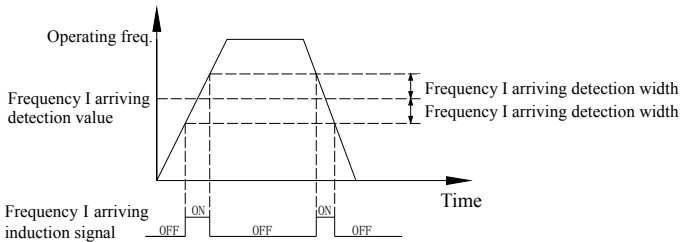

Fig.7-29 Frequency arriving detection diagram

F09.24	Positive and negative logic setting of output terminal	Range: 0000~FFFF	0000
---------------	---------------------------------------------------------------	-------------------------	-------------

This parameter defines the output logic of the standard output terminal Y_i , relay RLY and expand output terminal EY_i , relays $ERY1$, $ERLY2$.

0: positive logic, output terminal and the common terminal close to the valid state, disconnect invalid state

1: reverse logic, output terminal and the common terminal close to the invalid state, disconnect valid state

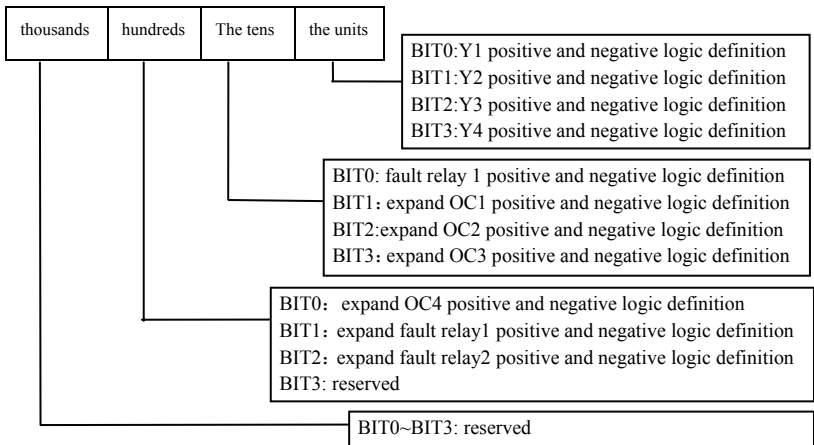

F09.25	Y1 output closed delay time	Range: 0.000~50.000s	0.000s
F09.26	Y1 output disconnected delay time	Range: 0.000~50.000s	0.000s
F09.27	Y2 output closed delay time	Range: 0.000~50.000s	0.000s
F09.28	Y2 output disconnected delay time	Range: 0.000~50.000s	0.000s
F09.29	Y3 output closed delay time	Range: 0.000~50.000s	0.000s
F09.30	Y3 output disconnected delay time	Range: 0.000~50.000s	0.000s
F09.31	Y4 output closed delay time	Range: 0.000~50.000s	0.000s
F09.32	Y4 output disconnected delay time	Range: 0.000~50.000s	0.000s
F09.33	Relay output closed delay time	Range: 0.000~50.000s	0.000s
F09.34	Relay output disconnected delay time	Range: 0.000~50.000s	0.000s

Parameter F09.25 ~ F09.34 defines the corresponding delay time from connect or disconnect to frequency level of the multifunction output terminals. Table 7-30 is the schematic of multi-function output terminal operation.

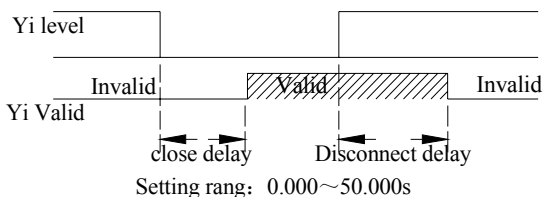

Fig.7-30 Multifunction output terminal action diagram

F09.35	Analog output (AO1) selecting	Range: 0~25	0
F09.36	Analog output (AO2) selecting	Range: 0~25	0
F09.37	DO function selecting(reuse with Y4)	Range: 0~25	0

0:output frequency before slip compensation(0.00Hz~ upper limit frequency)

1:output frequency after slip compensation(0.00Hz~ upper limit frequency)

2: setup frequency(0.00Hz~ upper limit frequency)

3:master setup frequency(0.00Hz~ upper limit frequency)

4:auxiliary setup frequency(0.00Hz~ upper limit frequency)

- 5:current output 1(0~2×rated current of frequency inverter)
 6:current output 1(0~3×rated current of frequency inverter)
 7:output voltage(0~1.2×rated voltage of load motor)
 8: bus voltage (0~1.5×Rated bus voltage)
 9:motor speed(0~3 ×rated speed)
 10:PID given(0.00~10.00V)
 11:PID feedback(0.00~10.00V)
 12:AI1(0.00~10.00V or 4~20mA)
 13:AI2(-10.00~10.00V or 4~20mA)
 14: communication given(AO output is controlled by communication, please refer to the related communication protocol for details.)
 15:motor rotate speed (0.00Hz~upper limit frequency)
 16:current given torque (0~2 times of rated torque)
 17:current output torque(0~2 times of rated torque)
 18:current torque current(0~2 times of rated motor current)
 19:current flux current(0~1 times of rated motor flux current)
 20~25:reserved



Note

- 1.Terminal AO1 and AO2 are optional output terminal of 0~10V or 4~20mA which can satisfy the variety needs of customer.
- 2.By disposing F00.21 analog output, output of terminal AO1 and AO2 can be 0~10V or 4~20mA to satisfy the variety needs of customer.
- 3.The unit's place of F00.22 is set to 1 when DO output pulse signal.
- 4.Rated flux current=current value of F15.11 parameter.
 Rated torque current=sqrt (rated motor current×rated motor Current-rated flux current×rated flux current)

F09.38	Reserved		
--------	----------	--	--

F09.39	Analog output (AO1) filter time	Range: 0.0~20.0s	0.0s
F09.40	Analog output (AO1) gain	Range: 0.00~2.00	1.00
F09.41	Analog output (AO1) bias	Range: 0.0~100.0%	0.0%

Parameter F09.39 defines the filter time of A01 output, its reasonable setting can improve stability of analog output. But a higher setting will influence the rate of change, which can not reflect the instantaneous value of corresponding physical quantity.

If users want to change the display range or error correction table headers, you can achieve it by adjusting the output gain and bias of AO1.

When AO1 output voltage, the adjustment is as follows:

Analog output AO1(after revise)=output gain(F09.40)×analog output AO1(before revise)+output bias(F09.41)×10V

When AO1 output current, the adjustment is as follows:

Analog output AO1(after revise)=output gain(F09.40)×analog output AO1(before revise)+output bias(F09.41)×20mA



Note

This function code will influence analog output during modify processes.

F09.42	Analog output (AO2) filter time	Range: 0.0~20.0s	0.0s
F09.43	Analog output (AO2) gain	Range: 0.00~2.00	1.00
F09.44	Analog output (AO2) bias	Range: 0.0~100.0%	0.0%

Please refer to the function introduce of parameters F09.39~F09.41

F09.45	DO filter time	Range: 0.0~20.0s	0.0s
F09.46	DO output gain	Range: 0.00~2.00	1.00
F09.47	DO maximum pulse output frequency	Range: 0.1~20.0KHz	10.0KHz

Please refer to the function introduce of parameters F09.39~F09.41.

Maximum pulse output frequency of terminal DO corresponds to maximum select value of F09.37. For example, F09.31=0, terminal DO's function is: output frequency before slip compensation, which means Maximum pulse output frequency corresponds to upper frequency.

F09.48	Reserved		
F09.49	Reserved		
F09.50	Reserved		

7.11 Simple PLC/Multi-speed function parameters Group:F10

F10.00	Simple PLC operate setting	Range: unitdigit: 0~3 tens digit: 0~2 hundreds digit: 0,1 thousands digit: 0,1	0000
---------------	-----------------------------------	---------------------------------------------------------------------------------------------------	-------------

The simple PLC operation mode, re-start mode after interruption, unit of running time and the storage mode when power off can be set in different bit of parameter F10.00, details as follows:

Unit digit: simple PLC operation mode.

0:**No action**.PLC operation mode is disabled.

1:**Stop after single cycle**. as show in Fig.7-31, the drive stops automatically after one cycle of operation and will not start only when receiving RUN command again.

2: Maintain final value after one cycle, as show in Fig.7-32, the drive will keep running with the final value and the direction after complete one cycle operation, the drive won't stop according to the set stop mode until the stop command is available.

3: Continuous operation, as show in Fig.7-33, the drive will start next cycle of operation automatically after completing one cycle of operation until receiving STOP command then stop according the set stop mode.

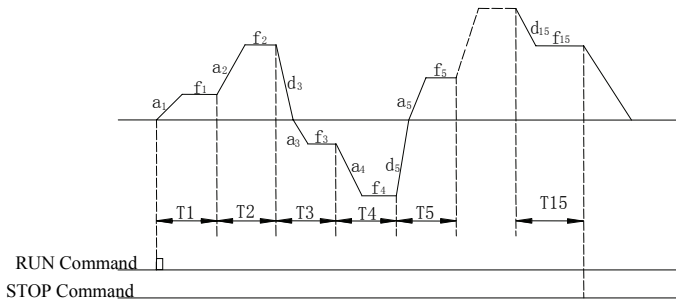

Fig.7-31 PLC stop operating after one cycle mode

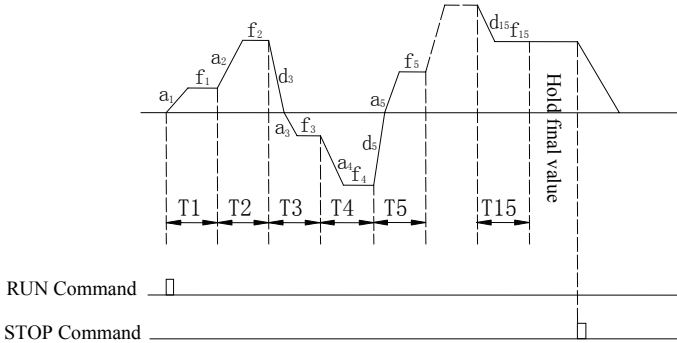

Fig.7-32 PLC holds the final value after one cycle mode

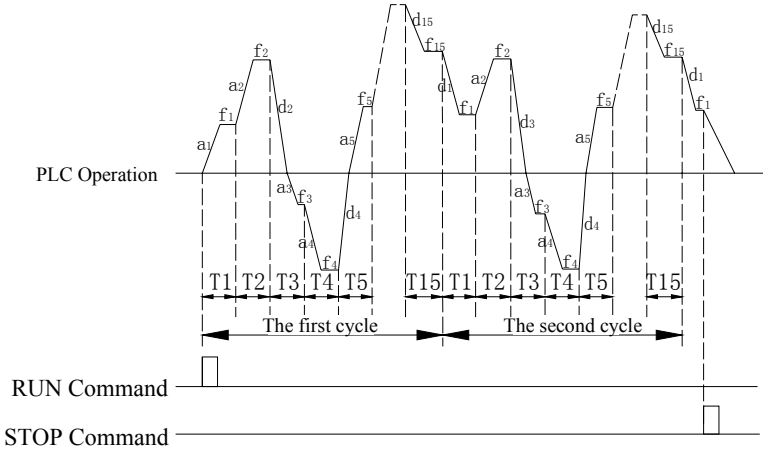

Fig7-33 PLC continuous operation mode

a1~a15: The Acc time of different steps

d1~d15: The Dec time of different steps

f1~f15: The frequency of different steps

There are 15 steps can set in Fig.7-31, 7-32, 7-33.

Tens digit: Restart mode after interruption.

0: Restart from the first step.

If the drive stops during PLC operation due to receiving STOP commands, fault alarm or power failure, it will run from the first step after restarting.

1: Restart from the interruption step;

If the drive stops during PLC operation due to receiving STOP command or fault

alarm, the drive will record the operating time of the current step and will continue from the step where the drive stops after restart at the frequency defined for this step with the remained time, as show in Fig.7-34.If the drive stops due to power off, it will not record the state and from the first step operate when restart.

2: Restart from the interrupted Frequency

If the drive stops during PLC operation due to receiving STOP command or fault alarm, the drive will record the operating time and the current frequency of the interrupt step, it will operating with the record time and record frequency when restart, as show in Fig7-35

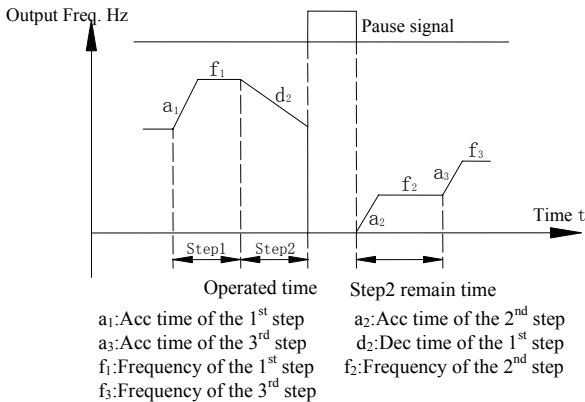

Fig.7-34 simple PLC restart mode 1

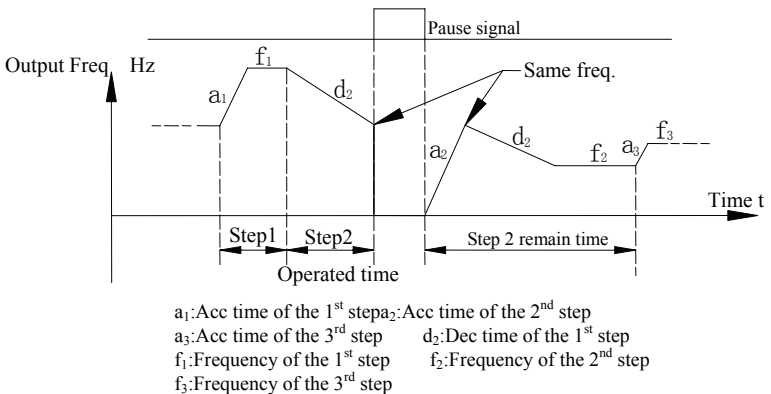

Fig.7-35 PLC Restart mode 2

Hundreds digit: PLC unit of running time.

0: Seconds;

1: Minutes;

The unit is effective for the running time of different steps only, during the operation of PLC, the unit of Acc time and Dec time is defined by parameter F01.19.



Note

1. The step is ineffective if the time of this step of PLC operation is set as 0 thereafter operate the next step.

2. Control the PLC process a pause ,ineffective, operate via terminal ,for details please refer to parameters in F8 Group that relative with terminal function.

Thousands digit: the storage mode when power off.

0: No storage. No record the running state when power off, it will restart from the first step when power on again.

1: Storage. Records the running status which include the step, running frequency and running time when power off, it restart with the mode that set in hundreds digit after power on again.



Note

No matter power-off storage in stop status or running status, you should set thousands digit as 1 thereafter set tens digit as 1 or 2,otherwise power-off storage function is ineffective.

F10.01	Step 1 setting	Range: 000H~E22H	000
F10.02	Step 2 setting	Range: 000H~E22H	000
F10.03	Step 3 setting	Range: 000H~E22H	000
F10.04	Step 4 setting	Range: 000H~E22H	000
F10.05	Step 5 setting	Range: 000H~E22H	000
F10.06	Step 6 setting	Range: 000H~E22H	000
F10.07	Step 7 setting	Range: 000H~E22H	000
F10.08	Step 8 setting	Range: 000H~E22H	000
F10.09	Step 9 setting	Range: 000H~E22H	000
F10.10	Step 10 setting	Range: 000H~E22H	000
F10.11	Step 11 setting	Range: 000H~E22H	000
F10.12	Step 12 setting	Range: 000H~E22H	000

F10.13	Step 13 setting	Range: 000H~E22H	000
F10.14	Step 14 setting	Range: 000H~E22H	000
F10.15	Step 15 setting	Range: 000H~E22H	000

F10.01~F10.15 are used to configure the operating frequency, direction and Acc/Dec time of each PLC operating step. These functions are all selected by digits on different place of parameters. Details as below:

Unit digit: Frequency setting

0:select multi-frequency i. i=1~15,please refer to F10.31~F10.45 for definitions of multi-frequency.

1:the frequency is determined by the combination of the main frequency and the auxiliary frequency.

2: Reserved.

Tens digit: Direction choosing

0: Forward.

1: Reversed.

2: Determined by operating commands (FWD, REV)

Hundreds digit: Acc/Dec time choose

0: Acc/Dec time 1

1: Acc/Dec time 2

2: Acc/Dec time 3

3: Acc/Dec time 4

4: Acc/Dec time 5

5: Acc/Dec time 6

6: Acc/Dec time 7

7: Acc/Dec time 8

8: Acc/Dec time 9

9: Acc/Dec time 10

A: Acc/Dec time 11

B: Acc/Dec time 12

C: Acc/Dec time 13

D: Acc/Dec time 14

E: Acc/Dec time 15

Accelerate time1~15 defined by F01.17,F01.18,F04.16~F04.43

F10.16	Step 1 running time	Range: 0~6000.0	10.0
F10.17	Step 2 running time	Range: 0~6000.0	10.0
F10.18	Step 3 running time	Range: 0~6000.0	10.0

F10.19	Step 4 running time	Range: 0~6000.0	10.0
F10.20	Step 5 running time	Range: 0~6000.0	10.0
F10.21	Step 6 running time	Range: 0~6000.0	10.0
F10.22	Step 7 running time	Range: 0~6000.0	10.0
F10.23	Step 8 running time	Range: 0~6000.0	10.0
F10.24	Step 9 running time	Range: 0~6000.0	10.0
F10.25	Step 10 running time	Range: 0~6000.0	10.0
F10.26	Step 11 running time	Range: 0~6000.0	10.0
F10.27	Step 12 running time	Range: 0~6000.0	10.0
F10.28	Step 13 running time	Range: 0~6000.0	10.0
F10.29	Step 14 running time	Range: 0~6000.0	10.0
F10.30	Step 15 running time	Range: 0~6000.0	10.0

Parameters F10.16~F10.30 defined Running time of each PLC Step from Step 1 to Step 15.



Note

Each step running time include Acc time and Dec time.

F10.31	Multi-Frequency 1	Range:0.00Hz~upper limit Freq.	5.00Hz
F10.32	Multi-Frequency 2	Range:0.00Hz~upper limit Freq.	10.00Hz
F10.33	Multi-Frequency 3	Range:0.00Hz~upper limit Freq.	20.00Hz
F10.34	Multi-Frequency 4	Range:0.00Hz~upper limit Freq.	30.00Hz
F10.35	Multi-Frequency 5	Range:0.00Hz~upper limit Freq.	40.00Hz
F10.36	Multi-Frequency 6	Range:0.00Hz~upper limit Freq.	45.00Hz
F10.37	Multi-Frequency 7	Range:0.00Hz~upper limit Freq.	50.00Hz
F10.38	Multi-Frequency 8	Range:0.00Hz~upper limit Freq.	5.00Hz
F10.39	Multi-Frequency 9	Range:0.00Hz~upper limit Freq.	10.00Hz
F10.40	Multi-Frequency 10	Range:0.00Hz~upper limit Freq.	20.00Hz
F10.41	Multi-Frequency 11	Range:0.00Hz~upper limit Freq.	30.00Hz
F10.42	Multi-Frequency 12	Range:0.00Hz~upper limit Freq.	40.00Hz

F10.43	Multi-Frequency 13	Range:0.00Hz~upper limit Freq.	45.00Hz
F10.44	Multi-Frequency 14	Range:0.00Hz~upper limit Freq.	50.00Hz
F10.45	Multi-Frequency 15	Range:0.00Hz~upper limit Freq.	50.00Hz

Frequency will be used in Multi-speed operation mode and Simple PLC operation mode. More details please refer to the Multi-speed terminal operation function in Parameters Group F08 and Simple PLC operation function in Parameters Group F10.

7.12 Closed-Loop PID operation Parameters Group:F11

Analog feedback control system:

Pressure reference is input through the terminal AI1, and water pressure sensor send a 4-20mA to the terminal AI2 of inverter as a feedback signal, all of them make up of analog closed-loop control system via build-in PID adjuster ,as shown in Fig.7-36

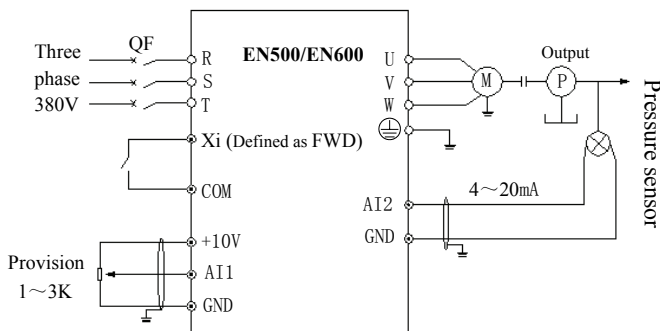

Fig.7-36 Build-in PID adjuster control system diagram



Setting the value of F11.01 can choose the channel of pressure reference.

Operating principle of built-in PID function of EN500/EN600 is shown in Fig.7-37 as below:

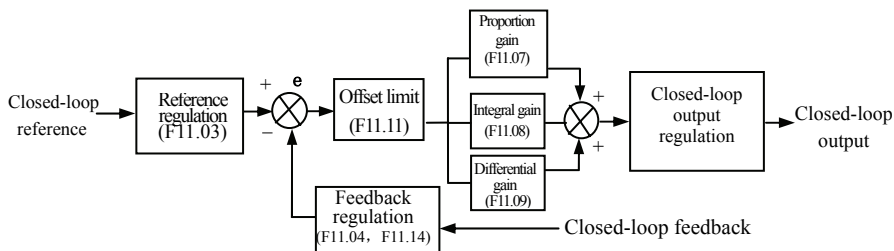

Fig.7-37 PID block control principle diagram

In above diagram ,the definition of closed-loop reference ,feedback error limit and PI parameters are similar with the general PID adjuster, the relationship between reference and expected feedback is shown in Fig.7-38.The reference and feedback

are converted and based on 10.00V.

In Fig.7-37, the real values of closed-loop reference and feedback can be regulated in Group F06 and F07, so that can reach a good performance.

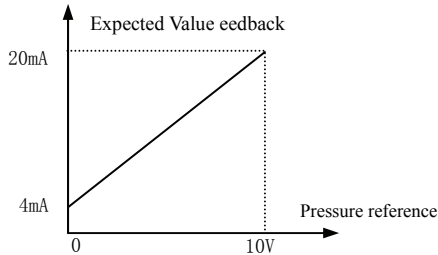

Fig.7-38 Reference and expected feedback value

After the system control mode is confirmed, follow the procedures below to set the closed-loop parameters:

- (1) Determine the closed-loop reference and feedback channel (F11.01~F11.02).
- (2) The relationship between the closed-loop reference and feedback should be defined for closed-loop control (the Group F6).
- (3) Set up the closed-loop frequency presetting function (F11.19, F11.20).
- (4) Adjust the proportion gain, integral gain, differential gain, sampling cycle and error limit (F11.07~F11.11).

F11.00	Closed-loop control function	Range: 0,1	0
---------------	-------------------------------------	-------------------	----------

0:PID closed-loop function disabled

1:PID closed-loop function enabled

F11.01	Reference channel choose	Range: 0~7	0
---------------	---------------------------------	-------------------	----------

0: Digital provision

1:AI1 analog 0-10V or 4-20mA provision

2:AI2 analog provision

3:EA11 analog provision (Extensible)

4:EA12 analog provision (Extensible)

5: Pulse provision

6: Communication provision(Please refer to the chapter of Modbus communication)

7: Reserved



Note

Except the above provision channels, Multi-Closed-loop provision is available. Connecting different terminal to choose different provision value which with a highest priority.

F11.02	Feedback channel selection	Range: 0~8	0
---------------	-----------------------------------	-------------------	----------

- 0:AI1 analog input**
- 1:AI2 analog input**
- 2:EA11 analog input(Extensible)**
- 3:EA12 analog input(Extensible)**
- 4:AI1+AI2**
- 5:AI1-AI2**
- 6:Min {AI1, AI2}**
- 7:Max {AI1, AI2}**
- 8: Pulse input**

F11.03	Provision channel filtering time	Range: 0.01~50.00s	0.20s
F11.04	Feedback channel filtering time	Range: 0.01~50.00s	0.10s
F11.05	PID output filtering time	Range: 0.00~50.00s	0.00s

The external reference signal and feedback signal usually carry some noise. those noise signal can be filtered by setting the time constant of filter in F11.03 and F11.04. The bigger the time constant is, the better the immunity capability, but with a slow response. The shorter the time constant is, the faster the response, but the immunity capability became weak.

The PID output filter time is the time of the filter for output frequency or torque, the bigger time, the slower the response output.

F11.06	Provision digital setting	Range: 0.00~10.00V	1.00V
---------------	----------------------------------	---------------------------	--------------

This function can realize digital setting of reference via keypad.



Note

When the PID function is enabled, Setting F18.14 as 1 can adjust pressure reference by press \uparrow \downarrow , otherwise the \uparrow \downarrow keys are invalid for adjusting reference in monitoring mode.

F11.07	Proportion Gain Kp	Range: 0.000~9.999	0.100
F11.08	Integral Gain Ki	Range: 0.000~9.999	0.100
F11.09	Differential Gain Kd	Range: 0.000~9.999	0.000

F11.10	Sampling cycle T	Range: 0.01~1.00s	0.10s
---------------	-------------------------	--------------------------	--------------

The bigger of the proportion gain of K_p , the faster the response, but oscillation may easily occur.

If only proportion gain K_p is used in regulation, the offset cannot be eliminated completely. To eliminate the offset, please use the integral gain K_i to form a PI control system. The bigger K_i is, the faster the response, but oscillation may easily occur if K_i is big enough.

The sampling cycle T refers to the sampling cycle of feedback value. The PI D regulator calculates once in each sampling cycle. The bigger the sampling cycle is, the slower the response.

F11.11	Deviation limit	Range: 0.0~20.0%	2.0%
---------------	------------------------	-------------------------	-------------

It defines the max. Deviation of the output from the reference, as shown in Fig.7-39, the PID adjuster stops operation when the feedback value within this range. Setting this parameter correctly will improve the moderation of the accuracy and stability of the system

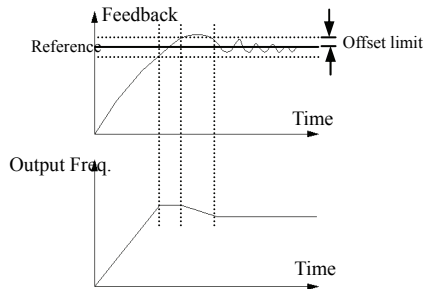

Fig.7-39 Offset limit



Offset limit is the percentage refer to the value of reference.

Note

F11.12	PID differential amplitude limit	Range: 0.00~100.00%	0.10%
---------------	-----------------------------------------	----------------------------	--------------

In the PID regulator, the effect of differential is too sensitive too easy to cause system oscillation, therefore limit the effect of differential PID in a smaller range, F11.12 the parameter that used to set the output range of PID differential.

F11.13	Closed-loop regulation characteristic	Range: 0,1	0
---------------	----------------------------------------------	-------------------	----------

0: Positive effect. When the provision increases, select while requiring speed of motor increase.

1: Negative effect. When the provision increases, select while requiring

speed of motor decrease.

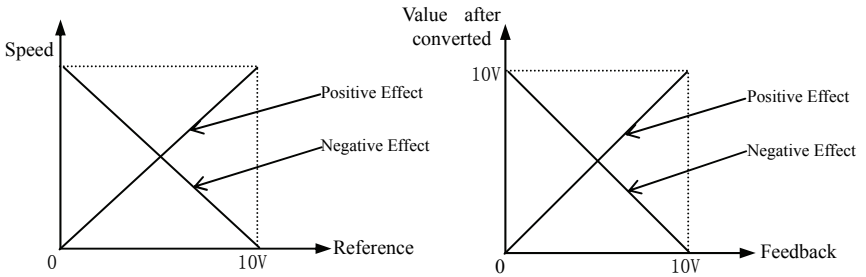

Fig.7-40 Closed-loop characteristic

Fig.7-41 Feedback characteristic

F11.14	Feedback channel positive-negative characteristic	Range: 0,1	0
---------------	----------------------------------------------------------	-------------------	----------

0: Positive characteristic. The relationship between reference and feedback is positive

1: Negative characteristic. The relationship between reference and feedback is negative

This parameter is used to change the feedback characteristic of the feedback signal. After input into inverter through the feedback channel, the feedback pressure will compare with the reference after regulated by the positive and negative characteristic regulation, as shown in Fig.7-41

F11.15	PID regulation upper limit frequency	Range: 0.00Hz~upper limit Frequency	50.00Hz
F11.16	PID regulation lower limit frequency	Range: 0.00Hz~upper limit Frequency	0.00Hz

User can set up the parameters F11.15 and F11.16 to define the output lower limit and upper limit frequency of the PID regulator.

F11.17	Integral regulation selection	Range: 0,1	0
---------------	--------------------------------------	-------------------	----------

0: Stop integral regulating when the comparison value of the reference and feedback reaches the range of threshold for integral separation

1: Keep integral regulating even though the comparison value of the reference and feedback reach the range of threshold integral separation

Adjusting this parameter can avoid integral saturation and improve the response of the system.

F11.18	PID threshold of the integral separation	Range: 0.0~100.0%	100.0%
---------------	-------------------------------------------------	--------------------------	---------------

PID integral separated function: there is no integral regulating just proportion regulating during closed-loop control when the comparison value that between

reference and feedback is bigger than this threshold. When the comparison is smaller than this threshold, the integral regulating will be active, and can adjust the response speed of system by adjusting this parameter.

F11.19	Preset Closed-loop frequency	Range: 0.00Hz~upper limit frequency	0.00Hz
F11.20	Holding time of preset Closed-loop frequency	Range: 0.0~6000.0s	0.0s

This function can make the closed-loop adjuster into the stable status quickly.

When the closed-loop function start, the output frequency will ramp up to the preset closed-loop frequency(F11.19) within the Acc time, and keep running the time that set in F11.20 then start the closed-loop operation as shown is Fig.7-42

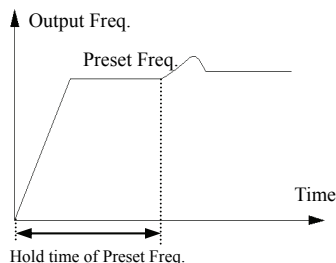

Fig.7-42 Preset closed-loop operating



Note

Preset closed-loop Function is ineffective when set F11.19 and F11.20 as 0.

F11.21	Closed-loop output reversion selection	Range: 0~2	2
---------------	-----------------------------------------------	-------------------	----------

0: The inverter will runs with the low limit frequency when the closed-loop output value is negative

1:The inverter will reverse running when the value of the closed-loop output is negative(be opposite of the initial direction)

2: determined by running demand. The motor running direction is determined by demand direction.



Note

The comparison value can be display in the PID monitor parameters, it's positive when the reference bigger than the feedback value, and negative when reference smaller than feedback value.

F11.22	Closed-loop output reversion frequency upper limit	Range: 0.00Hz~upper limit Frequency	50.00Hz
---------------	-----------------------------------------------------------	--------------------------------------------	----------------

The PID regulator is a kind of bipolar adjustment. By setting F11.21 and F11.22, can choose whether the inverter reverse run in some degree frequency or not.

F11.23	Multiple closed-loop provision 1	Range: 0.00~10.00V	0.00V
F11.24	Multiple closed-loop provision 2	Range: 0.00~10.00V	0.00V
F11.25	Multiple closed-loop provision 3	Range: 0.00~10.00V	0.00V
F11.26	Multiple closed-loop provision 4	Range: 0.00~10.00V	0.00V
F11.27	Multiple closed-loop provision 5	Range: 0.00~10.00V	0.00V
F11.28	Multiple closed-loop provision 6	Range: 0.00~10.00V	0.00V
F11.29	Multiple closed-loop provision 7	Range: 0.00~10.00V	0.00V

Among the closed-loop reference channel, besides the 7 channels defined by F11.01, the closed-loop reference can also be defined in F11.23~F11.29. The priority of multi-closed-loop reference control is higher than the reference channels that defined by F11.01.

Multi-closed-loop reference 1~7 can be selected by external terminals. Please refer to the terminal function 19~21 of introductions to F08.18~F08.25. When the function of Constant water supply is enable, the reference of constant water pressure is decided by the multi-closed-loop reference which selected by external terminals.

Computational formula: constant pressure reference = $F12.06 \times \text{Multi-closed-loop reference} / 10.00V$. By using this functions can realize different times with a different constant water pressure.

7.13 Constant pressure water supply function parameters Group: F12

F12.00	Constant pressure water supply mode selection	Range: 0~4	0
---------------	------------------------------------------------------	-------------------	----------

0: disabled.

1: Inverter works in one-drive-two-pump mode.

2: Choose extensible constant pressure board acts in one-drive-two-pump mode.

3: Choose extensible constant pressure board acts in one-drive-three-pump mode.

4: Choose extensible constant pressure board acts in one-drive-four-pump mode.

This function can be used to choose different kinds of constant pressure water supply mode, and you should choose an extensible constant pressure board to realize one-drive-three mode and one-drive-four mode and F00.19 should be set to 2.



Note

1. The function of Group F11 will be effective automatically when the constant pressure supply function is enabled.
2. Except for the related parameters in Group F11 and F12 for Closed-loop, the function of Yi should be enabled in F9 for the inverter works in one-drive-two-pump mode without an extend board.
3. Output terminal Y4/DO should be set to Y4.
4. When one inverter drive one pump with constant pressure water supply, the parameter F09.00~F09.03 (Y1~Y4) can not be set 37~38.

F12.01	Target pressure setting	Range: 0.000~the range of long-distance manometer	0.200Mpa
---------------	--------------------------------	----------------------------------------------------------	-----------------

This parameter defined the target pressure of the constant pressure supply system. The channels of the pressure reference and feedback are defined by F11.01 and F11.02.

F12.02	Sleep frequency threshold	Range: 0.00Hz~upper limit frequency	30.00Hz
F12.03	Revival pressure threshold	Range: 0.000~F12.06 Mpa	0.150Mpa

The function of Sleep frequency threshold: To save energy and protect the motor, when the water feedback pressure within the offset limit (F11.11), and the operating frequency is under in the sleep frequency threshold (F12.02), after a sleep delay time (F12.04), the system will enter a sleep mode and the operating frequency will drop to 0.00Hz

Revival function: When the system is in the sleep mode, if the feedback water pressure keep less than F12.03 (the revival pressure) a delay time (F12.05), the system will revival from the sleep mode.

F12.04	Sleep delay time	Range: 0.0~6000.0s	0.0s
---------------	-------------------------	---------------------------	-------------

This parameter is the delay time that from the feedback pressure meets the sleep conditions to the system enter in sleep mode.

Within the sleep delay time, if the feedback pressure does not meet the sleep conditions, the system will not enter into sleep mode

Sleep function is disabled when F12.04=0.

F12.05	Revival delay time	Range: 0.0~6000.0s	0.0s
---------------	---------------------------	---------------------------	-------------

When the constant pressure supply system in the sleep state, if the feedback pressure of system less than F12.11 which defined the revival pressure threshold ,the system will revival and get out of sleep mode after the revival delay time.

F12.06	The range of long-distance manometer	Range: 0.001~9.999Mpa	1.000Mpa
---------------	---------------------------------------------	------------------------------	-----------------

This parameter defines the range of long-distance manometer. Setting this parameter can correspond to the maximum feedback pressure with the analog feedback signal 10V or 20mA

F12.07	Allowed deviation of upper limit frequency or lower limit frequency when add or reduce pump	Range: 0.1~100.0%	1.0%
---------------	----------------------------------------------------------------------------------------------------	--------------------------	-------------

When output frequency reaches the deviation range of upper limited frequency and the feedback is less than given value, adding pumps judge is available. When output frequency reaches the deviation range of lower limited frequency and the feedback is more than given value, decreasing pumps judge is available.

When F12.07=0.0%, output frequency reach upper or lower limitation frequency and the pressure meets the requirement, then decrease pumps is available.

F12.08	Pump switch judging time	Range: 0.0~999.9s	5.0s
---------------	---------------------------------	--------------------------	-------------

When the output frequency up to the upper limit frequency (F11.15) but the pressure still not meeting the requirement, the system will add pump after the judging time.

When the output frequency down to the lower limit frequency (F11.16) but the pressure still not meeting the requirement, the system will reduce pump after the judging time.

F12.09	Electromagnetic contactor switching delay time	Range: 0.1~10.0s	0.5s
---------------	-------------------------------------------------------	-------------------------	-------------

This parameter defines the action delay time of magnetic control conductor when it's switch from power source supply to variable or from variable frequency control to power source supply.

F12.10	Automatic switching time interval	Range: 0000~9999Mins	0
---------------	------------------------------------------	-----------------------------	----------

By setting this parameter can avoid the rust of motor when it's not work long time. The inverter will switch the work status of the working pump and static pump automatically and smartly under the switch interval.

The automatic switch function is disabled when set the parameter as 0000. The system will switch one time when each restart of system as this parameter is 0001. If the value of this parameter is bigger than 0002, the system will switch automatically according the switch interval.

F12.11	Revival mode selection	Range: 0,1	1
F12.12	Revival pressure coefficient	Range: 0.01~0.99	0.75

When F12.11=0, the revival pressure of the constant pressure supply is the value of F12.03.

When F12.11=1, the revival pressure is the calculating value of $F12.12 * F12.01$

F12.13	Reserved		
F12.14	Reserved		

7.14 Traverse, Fixed-length control Function Parameters Group: F13

F13.00	Traverse function selection	Range: 0,1	0
---------------	------------------------------------	-------------------	----------

0: Disabled

1: Enabled

F13.01	Traverse operating mode	Range: unit digit: 0,1 tens digit: 0,1 hundreds digit: 0,1 thousands digit: 0,1	0000
---------------	--------------------------------	----------------------------------------------------------------------------------------------------	-------------

Unit digit: Start mode 1st

0: Auto start. The drive operates at the preset frequency of traverse for a certain time thereafter enter traverse mode automatically.

1: Terminal manual mode. Choosing multi-function terminal($X_i = X_1 \sim X_8$) as 56 function, when the terminal is enabled, the drive will enter traverse mode. The drive will exit traverse operation and operate at the pre-set traverse frequency when it's disabled.

Tens digit: Traverse amplitude AW mode choosing

0: Variable swing. Amplitude AW changes with the central frequency and the change rate relate to the definition of F13.02.

1: Fixed swing. Traverse operating amplitude AW is determined by Upper limit Frequency and F13.02.

Note: The traverse central frequency is set by the main frequency.

Hundreds digit: Restart mode

0: Restart at the initial state.

1: Restart at the memorized state before stopping

Thousands digit: Traverse state saving when power off.

This function is effective when the start mode is Restarting from the reserved memory state, and saving operating state when power off.

0: Not save

1: Save



Note

When in variable amplitude mode, the channel of central frequency is confirmed by F01.06. During the traverse frequency operation, the Acc and Dec time are controlled only by traverse frequency circle F13.04 when adjusting the central frequency.

F13.02	Traverse frequency swing value	Range: 0.0~50.0%	10.0%
---------------	---------------------------------------	-------------------------	--------------

Variable amplitude: $AW = \text{the central frequency} \times F13.02$

Fixed amplitude: $AW = \text{Upper limit frequency} \times F13.02$



Note

The traverse operating frequency is restricted by the upper and lower limit of frequency. Incorrectly setting the frequency will lead to abnormal of traverse operation.

F13.03	Sudden-jump frequency	Range:0.0~50.0%	2.0%
---------------	------------------------------	------------------------	-------------

As shown in Fig.7-43, there is not a jitter frequency when $F13.03=0$.

F13.04	Traverse cycle	Range:0.1~999.9s	10.0s
---------------	-----------------------	-------------------------	--------------

F13.04 defines a complete cycle of traverse operation which including rising and falling processed.

F13.05	Triangular wave rising time	Range:0.0~98.0%(Traverse cycle)	50.0%
---------------	------------------------------------	----------------------------------------	--------------

Definition traverse rising time= $F13.04 \times F13.05$ (s), the traverse falling time= $F13.04 \times (1-F13.05)$ (s).

Please refer to Fig.7-43

F13.06	Preset frequency of Traverse	Range:0.00~400.00Hz	0.00Hz
---------------	-------------------------------------	----------------------------	---------------

F13.06 defines the operating frequency of the Drive before entering traverse operation.

F13.07	Traverse preset frequency waiting time	Range:0.0~6000.0s	0.0s
---------------	-----------------------------------------------	--------------------------	-------------

F13.07 defines the operating time of Preset frequency before entering Traverse operation when auto-start mode is enabled.

If manual start mode is available, F13.07 is disabled.

Please refer to Fig.7-43 as below.

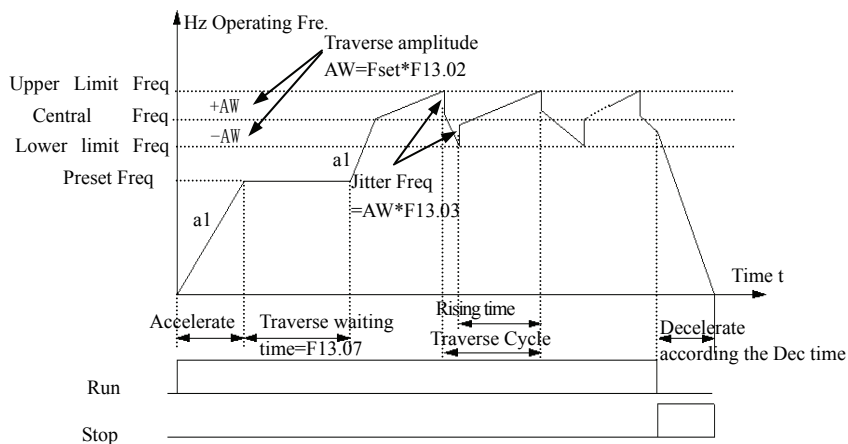

Fig.7-43 Traverse operation

F13.08	Setting length	Range: 0~65535m	0m
F13.09	Number of pulses for axis per circle	Range: 1~10000	1
F13.10	Perimeter of shaft	Range: 0.01~100.00cm	10.00cm
F13.11	Reserved		
F13.12	Correction coefficient of length	Range: 0.001~1.000	1.000

Set length, Actual length and Numbers of pulses per cycle are used for fixed length control.

The Actual length is calculated by the number of pulses collected by terminal Xi(i=1~8).

Allocate corresponding Xi terminal with 62(Length count input).

Actual length=(The number of Pulses×F13.10×F13.12)/ F13.09.

When the actual length (F00.02 = 39)exceeds the set length (F13.08), the drive can output a “Length reached” signal via Yi or relay.



Note

When F00.02=39, Actual length can be monitored by C-01 in running state, Count length function is available both V/F control mode and Vector Control mode.

F13.13	Processes when reaching the set length	Range: 0,1	1
---------------	-----------------------------------------------	-------------------	----------

0: Reset

When reaching the set length, the counter reset automatically.
Restart counting with the coming of next pulse.

1: Keep the record

When reaching the set length, the counter keep the record at present.

F13.14	Processes of length record when stop	Range: 0,1	1
---------------	---------------------------------------------	-------------------	----------

0: Reset

The counter reset automatically when stop the drive.

1: Keep the record.

When stop the drive, the counter keep the record at present.

7.15 Vector Control parameters Group: F14

F14.00	Speed/Torque control selection	Range: 0,1	0
---------------	---------------------------------------	-------------------	----------

0: Speed control mode

1: Torque control mode (this parameter is effective when set F00.24 as 1 or 2).

When the control mode is vector control with PG or without PG, the user can select torque control or speed control by setting the parameter of F14.00 or through control multi-function terminal which selected as No.65 function.

F14.01	Speed loop high speed proportional Gain	Range:0.1~40.0(Valid when F00.24=1 or 2)	20.0
F14.02	Speed loop high speed integral time	Range:0.001~10.000s(Valid when F00.24=1 or 2)	0.040s
F14.03	Speed loop low speed proportional Gain	Range:0.1~80.0(Valid when F00.24=1 or 2)	20.0
F14.04	Speed loop low speed integral time	Range:0.001~10.000s(Valid when F00.24=1 or 2)	0.020s
F14.05	Speed loop parameter switching frequency	Range:0.00Hz~20.00Hz(Valid when F00.24=1 or 2)	5.00Hz

Through F14.01 to F14.05, you can set the proportional gain and integral time of Speed loop regulator, so as to change the speed response characteristic under vector control mode.

The system dynamic response of speed loop can be faster if the proportional gain is increased or the integral time is decreased. However, if the proportional gain is too large or the integral time is too small, the system tends to oscillate.

The suggested adjusting way as below:

When the default parameter is not suitable, please fine adjust the parameters based on the default value. Proportional gain is usually adjusted first. Under the condition that the system is immune from oscillation, proportional gain can be increased as big as possible. Then adjust integral time so that the system responds fast and will not be over adjusted.

The above parameters are valid for Closed-loop or Open-loop speed control mode, invalid for V/F control and torque control mode.

F14.06	Stable coefficient of low frequency generating	Range: 0~50(Valid when F00.24=1 or 2)	16
---------------	-------------------------------------------------------	----------------------------------------------	-----------

When the motor connected to frequency inverter under a low frequency generating status, Please adjusting this parameter appropriately.

For example, the frequency inverter will be unstable when drives a potential load which is declining gradually. Increasing F14.06 will improve the stability of the system.

F14.07	Current loop proportional gain	Range: 1~500(Valid when F00.24=1 or 2)	70
F14.08	Current loop integral time	Range: 0.1~100.0ms(Valid when F00.24=1 or 2)	4.0ms

F14.07 and F14.08 are the PI regulator parameters of Current loop.

The system torque dynamic response can be faster if the Current loop proportional gain P is increased or Current loop integral time constant Ti is decreased.

The system stability can be improved if the Current loop proportional gain P is decreased or integral time constant Ti is increased.

In general, the above parameters don't need change.

F14.09	Motor-driven torque current limit value	Range: 0.0~250.0%(Valid when F00.24=1, 2 and 3)	180.0%
F14.10	Braking torque current limit value	Range: 0.0~250.0%(Valid when F00.24=1 or 2)	180.0%

It is the range of output torque of speed loop defined by the positive torque and negative torque limit. When the application needs quick acceleration and deceleration, this parameter can be appropriately increased to meet the specific requirements. However, if it's too large, the drive tends to over-current.

In torque control mode, the range of actual torque output is restricted to the above limit too.

F14.11	Asynchronous motor flux-weakening control coefficient	Range: 20.0~100.0%(Valid when F00.24=1 or 2)	80.0%
F14.12	Asynchronous motor Min. flux coefficient	Range: 10.0~80.0%(Valid when F00.24=1 or 2)	10.0%

Parameters of F14.11, F14.12 Used to correcting the weakening curve in weakening field. The correction of the curve will improve the precision of speed control during weakening field. The minimum field reference is the minimum value of weakening field. And F14.12 is just available for Closed-loop vector control mode.

F14.13	Torque provision channel selection	Range: 0~8	0
---------------	-------------------------------------------	-------------------	----------

0: Digital setting

1:AI1 analog provision(0-10V or 4-20mA corresponds to 0~200.0% Rated torque current of the motor)

2:AI2 analog provision

3: Terminal UP/DOWN adjusting

4:Communication provision(0~10000 corresponds to 0~200.0% Rated torque current of the motor)

5:EA11 analog provision (Extensible)

6:EA12 analog provision (Extensible)

7: High speed Pulse provision (Please choose the related function of X8)

8: Terminal width provision (Please choose the related function of X8)

The range of the above channels which from the Min value to the Max value corresponds to 0.0~200% Rated torque current of motor.

F14.14	Torque polarity setting	Range: 00~11	00
---------------	--------------------------------	---------------------	-----------

Unit digit: Polarity of Torque reference

0: Positive

1: Negative

Tens digit: Polarity of Torque compensation

0: Same direction with torque reference

1: Opposite direction with torque reference

F14.14 defines the polarity of torque compensation and torque reference. When select AI2, EAI1, EAI2 as provision channels and set as bipolar mode, the polarity of torque provision depends on the polarity of the analog. At this time, the units digit of F14.14 is invalid.

It's available changing the direction of torque provision through multi-function key.

F14.15	Torque digital setting value	Range:0.0~200.0%(Valid when F00.24=1 or 2)	0.0%
---------------	-------------------------------------	---------------------------------------------------	-------------

When F14.13=0, the value of torque provision is set by F14.15. A 100.0% value of F14.15 corresponds to the rated current of motor. The actual output torque will be decreased when the motor under a weakened field status. When choosing digital setting, press up and down keypad can revise the torque value.

F14.16	Forward speed limit channel selection in torque control mode	Range: 0~8	0
F14.17	Reverse frequency limit channel selection in torque control mode	Range: 0~8	0

0: Digital setting

1:AI1 analog provision

2:AI2 analog provision

3: Terminal UP/DOWN adjusting

4: Communication provision

5:EAI1 analog provision (Extensible)

6:EAI2 analog provision (Extensible)

7: High speed Pulse provision (Please choose the related function of X8)

8: Terminal width provision (Please choose the related function of X8)

When positive torque provided, if the load torque is smaller than the output torque, the motor's rotational speed will rise forward continuously to the forward

frequency limit defined by limit channel (F14.16),so as to avoiding runaway of the motor.

When negative torque provided, if the load torque is smaller than the output torque, the motor's rotational speed will rise reverse continuously to the reverse frequency limit defined by limit channel (F14.17),so as to avoiding runaway of the motor.

F14.18	Forward Speed limit in Torque control mode	Range: 0.00Hz~Upper limit freq.(Valid when F00.24=1 or 2)	50.00Hz
F14.19	Reverse Speed limit in Torque control mode	Range: 0.00Hz~Upper limit freq.(Valid when F00.24=1 or 2)	50.00Hz

When F14.16=0, F14.17=0, the related limit frequency of the positive torque or negative torque are confirmed by F14.18 and F14.19.

F14.20	Acc and Dec time of torque provision	Range: 0.000~60.000s Valid when F00.24=1 or 2)	0.100s
---------------	---------------------------------------------	-------------------------------------------------------	---------------

The torque provision from the provision channel will form the final torque provision after the Acc and Dec time of F14.20.Suitable value of F14.20 can avoid vibration of the motor which caused by saltation of torque provision.

F14.21	Torque compensation	Range: 0.0~100.0% Valid when F00.24=1 or 2)	0.0%
---------------	----------------------------	----------------------------------------------------	-------------

Tens digit of F14.14 and F14.21 define the characteristic and value of torque compensation. When Large torque losing which caused by mechanical losing of motor, Setting torque compensation is needed.100% of F14.21 corresponds to the rated torque current of motor.

F14.22	Positive torque gain regulation coefficient	Range: 50.0~150.0% Valid when F00.24=1 or 2)	100.0%
F14.23	Negative torque gain regulation coefficient	Range: 50.0~150.0% Valid when F00.24=1 or 2)	100.0%

When choosing positive torque provision, adjusting F14.22 will correct the matching of the actual output torque and the torque provision if they are unmatched.

When choosing negative torque provision, adjusting F14.23 will correct the matching of the actual output torque and the torque provision if they are unmatched.

F14.24	Flux braking coefficient	Range: 0.0~300.0% (Valid when F00.24=1 or 2)	0.0%
---------------	---------------------------------	-----------------------------------------------------	-------------

Under open-loop and closed-loop speed control mode, increasing the strength of the field can realize fast decreasing of the motor when stop. The energy generated during the field braking process will be consumed in a form of heat inside of the motor. As a result, the temperature of motor inside will increase when field

braking frequently. Please care about the temperature of the motor not over the allowed maximum value. If an operation command be given during the process of field braking, the field braking function will be canceled and the frequency inverter will operate to the set frequency again. Please disable the field braking function when using braking resistor.

F14.25	Pre-excitation start-up time constant	Range: 0.1~3.0(Valid when F00.24=1)	0.5
---------------	----------------------------------------------	--------------------------------------------	------------

In SVC control mode, decrease the value of F14.25 appropriately will decrease the start time of the motor, realizing fast start performance.

F14.26	Speed loop proportional gain	Range: 0.010~6.000(Valid when F00.24=3)	0.500
F14.27	Speed loop integral time constant	Range: 0.010~9.999(Valid when F00.24=3)	0.360

Adjusting F14.26 and F14.27 will change the responsive characteristic of Vector control.

F14.28	Motor stabilization coefficient	Range: 10~300(Valid when F00.24=3)	100
---------------	----------------------------------------	-------------------------------------------	------------

When the motor which connected to the drive is vibration and not stable, increasing F14.28 will get rid of the vibration.

F14.29	Compensation gain of vibration restrain	Range: 100.0~130.0%(Valid when F00.24=3)	100.0%
---------------	------------------------------------------------	-------------------------------------------------	---------------

The compensation is 0 when F14.29=100%.Large enough of this value will lead to over-current when start operation.

F14.30	Torque compensation limit frequency	Range: 0.00Hz~Upper limit Freq(Valid when F00.24=1,2)	0.00Hz
---------------	--------------------------------------------	--------------------------------------------------------------	---------------

When the output frequency is bigger than the value of F14.30, the torque compensation defined by F14.21 is 0.And the actual torque compensation will linear decrease from 0Hz to the frequency of F14.30.

7.16 Motor parameters Group: F15

F15.00	Reserved		
F15.01	Asynchronous motor rated power	Range: 0.1~999.9KW	Depend on type
F15.02	Asynchronous motor rated voltage	Range: 1~690V	Depend on type
F15.03	Asynchronous motor rated current	Range: 0.1~6553.5A	Depend on type
F15.04	Asynchronous motor rated frequency	Range: 0.00~400.00Hz	Depend on type
F15.05	Asynchronous motor rated rotational speed	Range: 0~60000r/min	Depend on type
F15.06	Asynchronous motor Poles No.	Range: 1~7	2

Set the parameters according to the motor nameplate no matter whether V/F control mode or vector control mode is adopted, otherwise it may be abnormal.

To achieve better V/F or vector control performance, motor auto-tuning is required.

The motor auto-tuning accuracy depends on the correct setting of motor nameplate parameters.

F15.07	Asynchronous motor Stator resistance	Range: 0.001~65.535Ω(AC drive power<7.5KW)	Depend on type
		Range: 0.0001~6.5535Ω(Ac drive power≥7.5KW)	
F15.08	Asynchronous motor Rotor resistance	Range: 0.001~65.535Ω(AC drive power<7.5KW)	Depend on type
		Range: 0.0001~6.5535Ω(Ac drive power≥7.5KW)	
F15.09	Asynchronous motor leakage inductance	Range: 0.01~655.35mH(AC drive power<7.5KW)	Depend on type
		Range: 0.001~65.535mH (AC drive power≥7.5KW)	
F15.10	Asynchronous motor mutual inductance	Range: 0.1~6553.5mH (AC drive power<7.5KW)	Depend on type
		Range: 0.01~655.35mH (AC drive power≥7.5KW)	
F15.11	Asynchronous motor no-load current	Range: 0.01~655.35A	Depend on type



F15.07~F15.11 is the characteristic parameters of asynchronous motor, not display on the nameplate, which need detected by auto-tuning. To achieved a good control performance, please let the motor unload before start rotating auto-tuning. For the asynchronous motor that cannot be disconnected from the load, you can choose static auto-tuning or input the motor parameters manually. Another way is just set F15.01 and used the default parameters in F15.01~F15.11. Meantime, Choosing different type of G and P will also change the default parameters in F15.01~F15.11.

F15.12 ~ F15.18	Reserved		
-------------------------------------	-----------------	--	--

F15.19	Motor parameter auto-tuning selection	Range: 0~3	0
---------------	----------------------------------------------	-------------------	----------

0: No action

1: Static auto-tuning

It is applied to applications where the motor cannot be disconnected from the load or the process is complicated. Values on the motor's nameplate should be input correctly before starting auto-tuning(F15.01-F15.06), Set F15.11 as 1 and press , back to monitoring mode, then press  to start auto-tuning which with a "tune" symbol on the keyboard.



After auto-tuning, the Drive will exit process automatically and the detected values of the stator's resistance, rotor's resistance and the leakage inductance will be saved in F15.07-F15.09.

In static auto-tuning mode, the value of No-load current and mutual inductive reactance will not be detected. The user can input the related values with the reference of the Motor factory data or the data on the motor test report. Without related value, please adopt the Default value. Otherwise it may cause negative influence on the performance of motor.

During the process of auto-tuning, any abnormal please press  to stop auto-tuning.

2: Rotating auto-tuning of Asynchronous motor

Rotating auto-tuning function is suitable for the applications which the load of motor is lighter than 30% of the rated load or some kind of small inertia load. Please try your best to disconnect the load of your motor and make the motor in static or unload state so that auto-tuning the value of motor exactly.

Values on the motor's nameplate should be input correctly before starting auto-tuning(F15.01-F15.06), Set F15.19 as 2 and press , back to monitoring mode, then press  to start auto-tuning which with a "tune" symbol on the

keyboard.

After auto-tuning, the Drive will exit process automatically and the detected values of the stator's resistance, rotor's resistance, the leakage inductance, No-load current and mutual inductive reactance will be saved in F15.07-F15.11.

During the process of auto-tuning, any abnormal please press  to stop auto-tuning.

3: Reserved

F15.20 ~ F15.22	Reserved		
-------------------------------------	-----------------	--	--

7.17 Closed-loop encoder parameters Group: F16

F16.00	Reserved		
F16.01	Encoder line number	Range: 0~10000	1024

This parameter should be set as same as the value of encoder installed on the axis of motor, or it will lead to an offset between the monitor speed and the actual speed of the motor.

F16.02	Direction of encoder	Range: units digit:0,1 tens digit: reserved	00
---------------	-----------------------------	--------------------------------------------------------	-----------

Units digit: Phase sequence of AB phase

0: Forward

1: Reverse

Tens digit: Reserved

The above parameters define the Encoder pulses per revolution and AB phase sequence of encoder, wrong phase sequence will lead to over-current alarm of the drive.

F16.03	Encoder fractional frequency coefficient	Range: 0.001~60.000	1.000
---------------	-------------------------------------------------	----------------------------	--------------

This parameter can correct the actual speed of the motor when the encoder not installed on the axis of motor.

For example, when the encoder installed on a reduction gears with a 10:1 ratio, you should set F16.02 as 10.000 so that get a correct feedback of actual motor speed.

Because of encoder usually install on the axis of motor in closed-loop vector control mode, so there is no need setting this parameters in this mode.

F16.04	Encoder filtering coefficient	Range: 5~100	15
---------------	--------------------------------------	---------------------	-----------

In some occasion with strong interference, increasing the value of F16.04 properly will weaken the vibration of the motor which because of the interference of the encoder signal. Meantime, a too big and too small value of F16.04 will lead to the vibration of the system.



Note

Except for correct setting of F16 parameters Group, Correct setting of F00.19 is also needed for a normal Closed-loop vector control.

F16.05 ~ F16.13	Reserved		
-------------------------------------	-----------------	--	--

7.18 Reserved parameters Group1:F17

F17.00 ~ F17.20	Reserved		
-------------------------------------	-----------------	--	--

7.19 Enhanced Control Functions Parameters Group: F18

F18.00	Operation panel control frequency binding	Range: 0~15	0
---------------	--------------------------------------------------	--------------------	----------

F18.00 can bundle operation panel with frequency reference channels, to achieve synchronous switching.

0: No bundling

1: Keyboard digital provision

2:AI1 analog provision

3:AI2 analog provision

4: Terminal UP/DOWN adjust setting

5: Communication provision (MODBUS and FieldBus used a same storage registers)

6:EAI1 analog provision (Extensible)

7:EAI2 analog provision (Extensible)

8: High speed Pulse provision (Please choose the corresponding functions of X8)

9: Terminal pulse-width provision (Please choose the corresponding functions of X8)

10: Terminal encoder provision (Defined by X1 and X2)

11~15:Reserved

Different control command channels can be bundled to the same frequency reference channel. After success bundled, the bundled frequency reference channel have a highest priority and just available for Main frequency bundling.

F18.01	Terminal control frequency binding	Range: 0~15	0
---------------	-------------------------------------------	--------------------	----------

Please refer to the description of F18.00

F18.02	Communication control frequency binding	Range: 0~15	0
---------------	------------------------------------------------	--------------------	----------

Please refer to the description of F18.00

F18.03	Digital frequency integral function selection	Range: units digit: 0,1 tens digit: 0,1	00
---------------	------------------------------------------------------	----------------------------------------------------	-----------

Units digit: Keyboard UP/DOWN Integration control

0: Integral function enabled

1: Integral function disabled

Tens digit: Terminal UP/DOWN Integration control

0: Integral function enabled

1: Integral function disabled

This function should cooperate with 16 and 17 functions of multi-function

terminal.

F18.04	Keyboard UP/DOWN integral rate	Range: 0.01~50.00Hz	0.10Hz
---------------	---------------------------------------	----------------------------	---------------

When the keyboard UP/DOWN Integration is enabled, if keep adjusting the frequency in the same direction, the Integration effect will be effective, and the Integration rate is determined by F18.04.

This function is suitable for the applications that need adjusting frequency quickly.

F18.05	Keyboard no integral single step's size setup	Range: 0.01~10.00Hz	0.01Hz
---------------	------------------------------------------------------	----------------------------	---------------

When the keyboard UP/DOWN integral function disabled, the rate of adjusting frequency fixed by the value of F18.05.

F18.06	Terminal UP/DOWN Integral rate	Range: 0.01~50.00Hz	0.20Hz
---------------	---------------------------------------	----------------------------	---------------

F18.07	Terminal no integral single step's size setup	Range: 0.01~10.00Hz	0.10Hz
---------------	------------------------------------------------------	----------------------------	---------------

Please refer to the functions of F18.04 and F18.05 for the functions of F18.06 and F18.07.

F18.08	Droop control decline frequency	Range: 0.00~10.00Hz	0.00Hz
---------------	----------------------------------------	----------------------------	---------------

When several drivers drive one load, the function can make the drives share the load equally. When the load of one drive is heavier, the drive will reduce its output frequency to shed part of the load.

This function is suitable for the share of several motors which with a common load. The value of F18.08 is the maximum reduced frequency when the drive reaches the rated power.

F18.09	Setup accumulate power on time	Range: 0~65535h	0
---------------	---------------------------------------	------------------------	----------

F18.10	Setup accumulate run time	Range: 0~65535h	0
---------------	----------------------------------	------------------------	----------

When the actual accumulate operation time reach to the set accumulated operation time (F18.10), the drive will output an indication signal. Please refer to the description of F09.00~F09.03.

F18.09 defined the expected accumulated time of power on from Ex factory.



Note

Power-on time and accumulated run time can be checked by monitoring parameters group C.

F18.11	Timing run function enable	Range: 0,1	0
---------------	-----------------------------------	-------------------	----------

0: Disabled

1: Enabled

F18.12	Timing run stop time	Range: 0.1~6500.0Min	2.0Min
---------------	-----------------------------	-----------------------------	---------------

When F18.11 Timing operation function enabled, the driver will start the timer with inverter start.

The drive will stop automatically and the multi-function Yi (Set Yi as the 33 function) will output an indicator signal when reach to the set stop time.



Note

The timer of inverter start form 0 every times, the user can monitor the current operation time through the F0 Group.

F18.13	Currently run arrival time	Range: 0.0~6500.0Min	1.0Min
---------------	-----------------------------------	-----------------------------	---------------

When the actual operation time reach to this time, the multi-function Yi (choose Yi as 34 function) will output an indicator signal of “Currently operation time reached”.

F18.14	Keyboard UP/DOWN selection under monitor mode	Range: 0~6	0
---------------	------------------------------------------------------	-------------------	----------

0: Keyboard frequency provision frequency adjusting

1: PID digital reference value adjusting

2~6:Reserved

When F18.14 =1, UP/DOWN is used to adjust the PID digital reference value in Monitor Mode merely.

When F18.14 =0, UP/DOWN is used to adjust the frequency value not only in Monitor Mode when choose frequency digital reference channel.

F18.15	V/F vibration restrain end frequency	Range: 0.00Hz~upper limit frequency	50.00Hz
---------------	---------------------------------------------	--------------------------------------------	----------------

In V/F Control mode, when the output frequency of inverter is bigger than the limit frequency, the suppression of F03.12 will be disabled. Adjusting F18.15 can restrain the shake phenomenon of motor in a large range.

F18.16	Torque closed loop control selection	Range: 0,1 (when F00.24=1 or 2)	1
---------------	---------------------------------------------	----------------------------------------	----------

When F18.16=0, torque open loop control is available

When F18.16=1, torque close loop control is available, which can increase the precision of torque control

F18.17 ~ F18.24	Reserved		
-------------------------------------	-----------------	--	--

7.20 Protective Relevant Function Parameters Group:F19

F19.00	Power off restart waiting time	Range: 0.0~20.0s (0 indicates disabled this function)	0.0s
--------	--------------------------------	----------------------------------------------------------	------

When the power is off, then power-on, whether this inverter will start automatically after a waiting time.

When F19.00=0.0s, after the power off then power-on, inverter will not start automatic. F19.00≠0.0s, after the power off then power-on again, if all is ready, inverter will run automatically with the start method defined by F02.00 after waiting the time defined by F19.00.



Note

Conditions for repower-on after power-off: it should be in the running status before power-off; there's no fault and running signal maintained when power-on again; there's no other factors which affect normal starting.

F19.01	Fault self-recovery times	Range: 0~10 (0 indicates no self-recovery function)	0
F19.02	Fault self-recovery interval time	Range: 0.5~20.0s	5.0s

When the inverter is running, because of fluctuation of load, faults may happen in some case and it will top to output. In order not to stop the operation of equipment, choosing the recovery functions No alarm, stop in stopping mode. Inverter will recovery to run with speed-checking restart style, within the setting time, if inverter cannot run, then fault protection will begin, stop running. No alarm, when the self recovery times of fault are set to 0, self recovery function stops.



- 1.When using fault self recovery function, and make sure the equipment is permitted and inverter do not enter fault.
- 2.Self recovery function have the effect on power-on terminal protection, clock fault. overload and over-heated, output short-circuit, short circuit to ground ,and the lack-voltage when running of fault Protection is disabled.
- 3.When F19.00≠0,open stop and restart function. We can start this equipment without operators, so be careful to use this function.

F19.03	Motor overload protection action selection	Range: 0~2	2
--------	--------------------------------------------	------------	---

When the AC motors is overloaded , this mode of Protection will happen.

0: Alarm, continue operation; It happens with only warning, no motor overload Protection characteristic (used cautiously, at this time, inverter has nothing to do with load motor for overload protection);

1: Alarm, Stop according to the stop mode;

2: Fault, Free stop. When it is overloaded, the output of inverter is block, this AC motor free stop.

F19.04	Motor overload protection coefficient	Range: 20.0~200.0% (Motor rated current)	150.0%
---------------	----------------------------------------------	-------------------------------------------------	---------------

In order to apply effective overload protection to different kinds of motors, the Max output current of the drive should be adjusted as shown in Fig. 7-44.

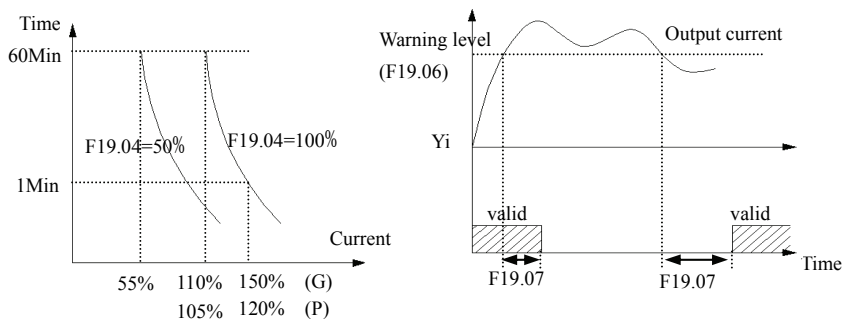

Fig.7-44 Electronic thermal relay protection Fig.7-45 Overload alarm

This adjustable value can base on the user's setting. In the same condition, if the AC motor is overloaded and need the fast protection, then decrease F19.04, or else increase.

F19.05	Inverter overload pre-alarm detection selection	Range: 0,1	0
---------------	--------------------------------------------------------	-------------------	----------

0: Detection all the time. during the working process of inverter, it still work after detecting overload situation.

1: Enable only constant speed detection. Only the inverter work in a constant speed mode, it still works after detecting overload situation.

F19.06	Inverter overload pre-alarm detection level	Range: 20~180% (Inverter rated current)	130%
F19.07	Inverter overload pre-alarm delay time	Range: 0.0~20.0s	5.0s

If output current higher parameter F19.06, the set electrical level will go though delay time of F19.07, open collector will output enabled signal (please refer to fig7-45 and parameter list F09.00~F09.03).

F19.08	Motor underload alarm detection level	Range: 0.0~120.0% (Motor rated current)	50.0%
F19.09	Motor underload alarm detection time	Range: 0.1~60.0s	2.0s

The output current Inverter will lower than Underload alarm detection level F19.08 (definite the value, comparing to motor rating current) , and the last time will over motor underload alarm detection level time F19.09, then Yi will output underload alarm Signal .

F19.10	Motor underload alarm detection action	Range: units digit: 0~2 tens digit: 0~2	00
---------------	-----------------------------------------------	----------------------------------------------------	-----------

Units digit: detection selection.

0: No detection.

1: The operation has been detected all the time. This detection is enabled during the running process of inverter.

2: Detect in constant speed mode only. This detection is enabled during the constant speed mode only.

Tens digit: action selection.

0: when it's in alarm, continue operation. inverter will only warn when detecting motor is underload alarm

1: Alarm, Stop according to the stop mode

2: Fault, Free stop .The inverter will detect motor is in underload alarm, and it will lock PWM output, the motor will stop with free rotation.

F19.11	Input & output phase loss, short circuit detection action	Range: units digit: 0,1 tens digit: 0,1 hundreds digit: 0,1 thousands digit: 0,1	1111
---------------	----------------------------------------------------------------------	-----------------------------------------------------------------------------------------------------	-------------

Units digit: input phase failure protect

0: No detection.

1: Fault, Free stop .When inverter detect that the input is lacked one phase, alarm in input lacked, alarm, and free stop.

Tens digit: output phase failure protection

0 : No detection.

1:Fault, Free stop .When inverter detect that the output is lacked one phase, alarm in input lacked, then Free stop.

Hundreds digit: power-on will detect Short circuit protection.

0: No detection.

1: Fault, Free stop. When inverter is power-on, the output to earth is short-circuiting. At this time, the fault of short-circuiting to earth while power on is alarmed, the inverter freely stops.

Thousands digit: The detection to earth Short circuit protection in the running

mode.

0: No detection.

1: Fault, Free stop. When inverter is power-on, the output to earth is short-circuiting during the running process. At this time, the fault of short-circuiting to earth while running is alarmed, the inverter freely stops.

F19.12	Overvoltage stall selection	Range: 0,1	1
---------------	------------------------------------	-------------------	----------

0: Disabled.

1: Enabled

F19.13	Overvoltage stall protection voltage	Range: 120~150%	125%
---------------	---------------------------------------------	------------------------	-------------

During deceleration, the motor's decelerate rate may be lower than that of drive's output frequency due to the load inertia. At this time, the motor will feed the energy back to the drive, resulting in the voltage rise on the drive's DC bus. If no measures taken, the drive will trip due to over voltage.

During the deceleration, the drive detects the bus voltage and compares it with the over voltage point at stall defined by F19.13. If the bus voltage exceeds the stall over-voltage point, the output frequency of the inverter will stop decreasing. When the bus voltage become lower than the point, then run slowly, as shown in Fig. 7-46.

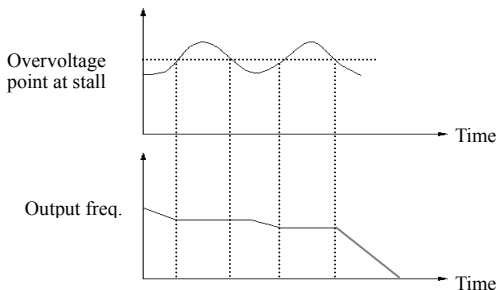

Fig. 7-46 Over-voltage at stall

F19.14	Automatic current limit level	Range: 110~230%	170%
F19.15	Frequency decline rate of automatic current limit	Range: 0.00~99.99Hz/s	10.00Hz/s
F19.16	Automatic current limit action selection	Range: 0,1	0

0: Constant speed disabled.

1: Constant speed enabled.

Auto current limiting function is used to limit the load current smaller than the

value defined by F19.14 in real time. Therefore the drive will not trip due to surge over-current. This function is especially useful for the applications with big load inertia or big change of load.

F19.14 defines the threshold of auto current limiting. It is a percentage of the drive's rated current.

F19.15 defines the decrease rate of output frequency when the drive is in auto current limiting status.

If F19.15 is set too small, overload fault may occur. If it is set too big, the frequency will change too sharply and therefore, the drive may be in generating status for longtime, which may result in overvoltage protection.

Auto current limiting function is always active in Acc or Dec process. Whether the function is active in constant speed operating process is decided by F19.16.

F19.16=0 Auto current limiting function is disabled inconstant speed operating process;

F19.16=1 Auto current limiting function is enabled inconstant speed operating process;

In auto current limiting process, the drive's output frequency may change; therefore, it is recommended not to enable the function when the drive's output frequency is required stable.

F19.17	Rapid current-limiting coefficient	Range: 150%~250%	230%
---------------	-------------------------------------------	-------------------------	-------------

The rapid current limit function can reduce the AC drive's over-current faults at maximum, guaranteeing uninterrupted running of the AC drive. If the AC drive is in a rapid current limit state for a long time, the AC drive may be overheated or overloaded for further protection.

The lower the setting of the F19.17, the more sensitive the rapid current limit is. When the F19.17 equals 250%, the rapid current limit function is invalid.

F19.18	Motor run section selection when instant power off	Range: 0,1	0
---------------	-----------------------------------------------------------	-------------------	----------

0: disabled

1: enabled

F19.19	Frequency droop rate when instant power off	Range: 0.00~99.99Hz/s	10.00Hz/s
F19.20	Voltage rebound estimate time when instant power off	Range: 0.00~10.00s	0.10s
F19.21	Action estimate voltage when instant power off	Range: 60~100%	80%
F19.22	Allowed the longest off time when instant power off	Range: 0.30~5.00s	2.00s

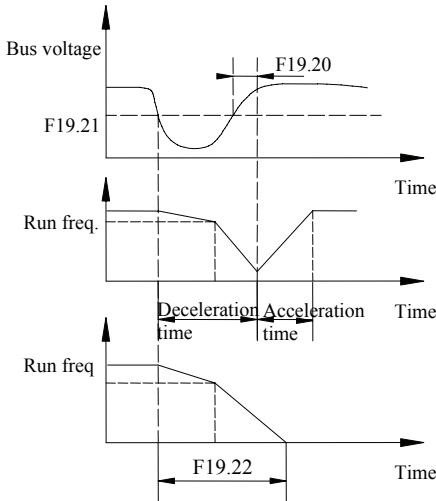

Fig 7-47 AC drive action diagram upon instantaneous power failure

Upon instantaneous power failure or sudden voltage dip, the DC bus voltage of the AC drive reduces. This function enables the AC drive to compensate the DC bus voltage reduction with the load feedback energy by reducing the output frequency so as to keep the AC drive running continuously.

If $F19.18 = 1$, upon instantaneous power failure or sudden voltage dip, the AC drive decelerates. Once the bus voltage resumes to normal, the AC drive accelerates to the set frequency. If the bus voltage remains normal for the time exceeding the value set in $F19.20$, it is considered that the bus voltage resumes to normal.

When instantaneous power failure happens, if the time is exceed the time of $F19.22$ definite, inverter No alarm, stop in stopping mode Free stop.

F19.23	Terminal external device fault action selection	Range: 0~2	2
---------------	--------------------------------------------------------	-------------------	----------

0: Alarm, continue operation .When inverter checked that Terminal of the external is no alarm, stop in stopping mode enabled, it will alarm, then run continue. Under this mode, the inverter will do nothing with Terminal of the external in No alarm, stop in stopping mode, so please cautiously use.

1: Alarm, Stop according to the stop mode .When Inverter detect terminal outside fault is enabled, alarm, and then press Stop in stopping mode.

2: Fault, Free stop .When inverter detect terminal external fault is enabled,

alarm for external equipment fault, and free stop.

F19.24	Power on terminal protection selection	Range: 0,1	0
---------------	-----------------------------------------------	-------------------	----------

0: Disabled.

1: Enabled.

When setting power down and then restart function is enabled, this function is disabled. When the running command channel is terminal command, and when power-on and detection run the command is enabled, it will get terminal protection with faults, this function only is enabled for terminal FWD/REV function.

F19.25	Provide lost detection value	Range: 0~100%	0%
F19.26	Provide lost detection time	Range: 0.0~20.0s	0.5s

When setting PID is lower than F19.25 definition continuous(setting the Max. as base), and the constant time is over than the time that F19.26 definition detected, then PID setting will lost, inverter will run base on F19.31 Units place set.PID loss detection show on fig 7-48.

F19.27	Feedback lost detection value	Range: 0~100%	12%
F19.28	Feedback lost detection time	Range: 0.0~20.0s	0.5s

When the feedback value of PID is lower than F19.27 definite(setting the input as base, and the constant time is over than the time that F19.28 definition detected, then PID setting will lost.

Inverter will run base on F19.31 Tens place set.PID loss detection show on fig 7-48.

F19.29	Deviation magnitude abnormal detection value	Range: 0~100%	50%
F19.30	Deviation magnitude abnormal detection time	Range: 0.0~20.0s	0.5s

When the Error amount of PID is higher than F19.29 definite(setting the input as base, and the constant time is over than the time that F19.30 definition detected, then PID setting will lost. inverter will run base on F19.31 hundred's place set.PID loss detection show on fig 7-48.

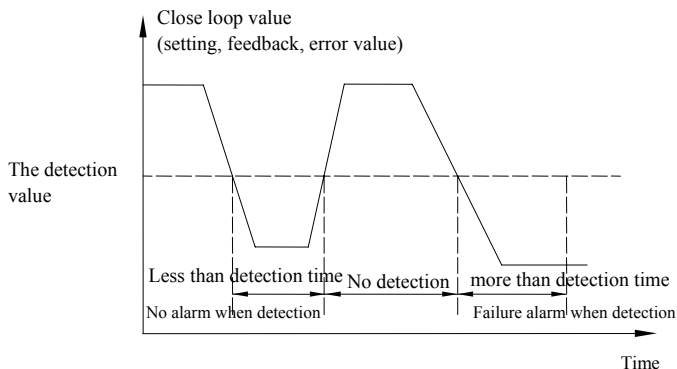

Fig. 7-48 Closed loop detection timing diagram

F19.31	Protection selection 1 action	Range: units digit: 0~3 tens digit: 0~3 hundreds digit: 0~3	000
---------------	--------------------------------------	----------------------------------------------------------------------------	------------

This parameter defines the Internal PID controls the action selection of the setting loss and the fault Error amount. When it's set as 0 OR 1, inverter will have no response. And with no protection selection, users should set this parameter basing on the actual applications.

Units digit: setting PID lost motion detection.

0: no detection.

1: Alarm, continue operation

2: Alarm, Stop according to the stop mode

3: Fault, Free stop.

Tens digit: PID feedback for lost motion detection.

0: no detection.

1: Alarm, continue operation.

2: Alarm, Stop according to the stop mode.

3: Fault, Free stop.

Hundreds digit: The amount of error fault for PID detection operation

0: no detection.

1: Alarm, continue operation

2: Alarm, Stop according to the stop mode

3: Fault, Free stop.

F19.32	Protection action selection 2	Range: units digit: 0~2 tens digit: 0~2 hundreds digit: 0~2 thousands digit: 0,1	1200
--------	-------------------------------	-------------------------------------------------------------------------------------------	------

This parameter definite the communication fault, E²PROM fault, Contactor fault and lack-voltage when it's in No alarm, stop in stopping mode for the action selection of inverter. When it's set as 0, during the fault situation, inverter will only alarm. And with no protection selection, users should set this parameter basing on the actual applications.

Units digit: communication fault action, including communication replay and fault.

0: Alarm, continue operation

1: Alarm, Stop according to the stop mode

2: Fault, free stop .

Tens digit: E²PROM fault action selection.

0: Alarm, continue operation

1: Alarm, stop according to the stop mode

2: Fault, free stop.

Hundreds digit: Contactor fault action selection.

0: Alarm, continue operation

1: Alarm, stop according to the stop mode

2: Fault, free stop.

Thousands digit: running lack-Voltage fault display action selection.

0: no detection.

1: Fault, free stop.

F19.33	Reserved		
F19.34	Reserved		

F19.35	Fault indication and clock during the period of recovery	Range: units digit: 0,1 tens digit: 0,1	00
--------	----------------------------------------------------------	--------------------------------------------	----

Units digit: During automatic reset of fault display selection.

0: Action. During automatic reset, Yi and Relay of will update display the Signal based on the internal state.

1: No action. During automatic reset, Yi and Relay display Signal No action.

Tens digit: Lock function selection, to realize display before power-off.

0: disabled.

1: enabled. When this function is enabled, if the inverter shows the fault before the last time power down, then the inverter will display the fault last time

fault state, make sure that users will know about the inverter's potential faults.

F19.36	Continuous run frequency selection when alarm	Range: 0~3	0
---------------	------------------------------------------------------	-------------------	----------

This parameter defines the run frequency when users choose “Alarm, continues to run” for the inverter's failure.

0: running at the current setting frequency.

1: running at the upper limiting frequency.

2: running at the lower limit frequency.

3: running at the fault Alternate frequency.

F19.37	Abnormal standby frequency	Range: 0.00Hz~upper limit frequency	10.00Hz
---------------	-----------------------------------	--------------------------------------------	----------------

This parameter define the alternative running frequency when inverter fault , user can use it along with parameter F19.36.

F19.38	Disconnection testing time of encoder	Range: 0.0~8.0s (No detection while at 0)	0.0s
---------------	----------------------------------------------	------------------------------------------------------	-------------

When the inverter runs with the closed-loop vector mode, the detection starts while the run frequency is higher than 1Hz, when the A,B-phase signal of the encoder continues for the time set in F19.38, and no feedback has been received, then the inverter alarms the fault of E-37 and freely stop.

F19.39	Overspeed detection value	Range: 0.0~120.0% (equals upper limit frequency)	120.0%
F19.40	Overspeed detection time	Range: 0.00~20.00s (no detection while at 0)	0.00s

Under the open-loop or the closed-loop vector mode, when it was detected that the motor rotational speed is higher than the setting value of F19.39, and after the continue time of F19.40's setting value, the inverter alarms fault of E-38 and freely stop. No detection when F19.40 equals 0, but detection is still available when F19.39 equals 0.

F19.41	Detection value of too large speed deviation	Range: 0.0~50.0% (equals upper limit frequency)	10.0%
F19.42	Detection time of too large speed deviation	Range: 0.00~20.00s (no detection while at 0)	0.00s

Under the open-loop or the closed-loop vector running mode, when it was detected that the difference of motor rotational speed and setting rotational speed equals the setting value of F19.41, and after the continue time of F19.42's setting value, the inverter alarms fault of E-39 and freely stop. No detection when F19.42 equals 0, but detection is still available when F19.41 equals 0.

F19.43	Overvoltage suppression coefficient	Range: 0.0~100.0%	90.0%
---------------	--------------------------------------------	--------------------------	--------------

The bigger value of F19.43, the more obvious the suppression will be, but the load response will be slow, the parameter is available when F00.24=1 or 2.

When the load fluctuation is strong, the devices like crusher, punch, pipe file machine and the equipment with clutch will be over-voltage easily, so increasing the parameter is needed.

F19.44	Reserved		
---------------	-----------------	--	--

7.21 Internal Virtual Input Output Node Parameter Group: F20

F20.00	Virtual input VDI1 function selection	Range: 0~90	0
F20.01	Virtual input VDI2 function selection	Range: 0~90	0
F20.02	Virtual input VDI3 function selection	Range: 0~90	0
F20.03	Virtual input VDI4 function selection	Range: 0~90	0
F20.04	Virtual input VDI5 function selection	Range: 0~90	0

VDI1 to VDI5 have the same functions as Xi terminals on the control board and can be used for digital input. For more details, see description of F08.18 to F08.25. The realization of the function set by internal virtual terminal must be based on the available terminal function.

F20.05	Virtual output VDO1 function selection	Range: 0~60	0
F20.06	Virtual output VDO2 function selection	Range: 0~60	0
F20.07	Virtual output VDO3 function selection	Range: 0~60	0
F20.08	Virtual output VDO4 function selection	Range: 0~60	0
F20.09	Virtual output VDO5 function selection	Range: 0~60	0

VDO functions are similar to the Yi functions on the control board. The VDO can be used together with VDIx to implement some simple logic control.

If VDO function is set to non-0, the function setting and use of VDOx are the same as the output of parameter of Yi. Please refer to descriptions in group F09.

F20.10	Virtual output VDO1 open delay time	Range: 0.00~600.00s	0.00s
F20.11	Virtual output VDO2 open delay time	Range: 0.00~600.00s	0.00s
F20.12	Virtual output VDO3 open delay time	Range: 0.00~600.00s	0.00s
F20.13	Virtual output VDO4 open delay time	Range: 0.00~600.00s	0.00s
F20.14	Virtual output VDO5 open delay time	Range: 0.00~600.00s	0.00s
F20.15	Virtual output VDO1 close delay time	Range: 0.00~600.00s	0.00s
F20.16	Virtual output VDO2 close delay time	Range: 0.00~600.00s	0.00s
F20.17	Virtual output VDO3 close delay time	Range: 0.00~600.00s	0.00s
F20.18	Virtual output VDO4 close delay time	Range: 0.00~600.00s	0.00s

F20.19	Virtual output VDO5 close delay time	Range: 0.00~600.00s	0.00s
---------------	---------------------------------------------	----------------------------	--------------

F20.10~ F20.19 definite the time of open up and shut down terminal VDO1~VDO5 definite is the delay time of internal level from open up to shut down.

F20.20	Virtual input VDI enable control	Range: 00~FF	00
---------------	-----------------------------------------	---------------------	-----------

Parameter F20.20 is to control VDI1~VDI5 is enable. F20.20(BIT0-BIT4) is according to the enable unit VDI1~VDI5, 0 stands for disabled , 1 stands for enable. The relations are below:

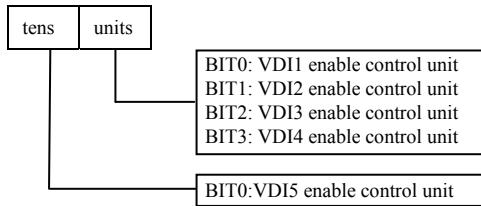

F20.21	Virtual input VDI status digital setup	Range: 00~FF	00
---------------	-----------------------------------------------	---------------------	-----------

Virtual input terminal VDI state is determined by the VDI F20.21 definite virtual input VDI state Digital and virtual output terminal VDO state, the relation between them is logical OR.

Parameter F20.21 BIT0-BIT4 is according to VDI1~VDI5 state, 0 stands for disabled state, 1 stands for enabled state.

F20.22	Virtual input: output connection	Range: 00~FF	00
---------------	-----------------------------------------	---------------------	-----------

Bit0 : The connection of VDI1 and VDO1

0 : positive logic.

1 : negative logic.

Bit1 : The connection of VDI2 and VDO2

0 : positive logic.

1 : negative logic.

Bit2 : The connection of VDI3 and VDO3

0 : positive logic.

1 : negative logic.

Bit3 : The connection of VDI4 and VDO4

0 : positive logic.

1 : negative logic.

Bit4 : The connection of VDI5 and VDO5

0 : positive logic.

1 : negative logic.

Parameter F20.22 definite logical relation if the virtual output terminal, Bit0~Bit4 is according to logical relation setting of VDI1~VDI5 and VDO1~VDO5 , 0 stands for positive logic , 1 stands for negative logic.



Note

Parameter F20.21 definition VDI state , the Digital setting will not influence by F20.22.

7.22 Reserved parameter group 2:F21

F21.00 ~ F21.21	Reserved		
-------------------------------------	-----------------	--	--

7.23 Reserved parameter group 3:F22

F22.00 ~ F22.17	Reserved		
-------------------------------------	-----------------	--	--

7.24 Reserved parameter group 4:F23

F23.00 ~ F23.17	Reserved		
-------------------------------------	-----------------	--	--

7.25 Reserved parameter group 5:F24

F24.00 ~ F24.13	Reserved		
-------------------------------------	-----------------	--	--

7.26 User Definition Display Parameter Group: F25





F25.00	User function code 1	Range: F00.00~F25.xx	25.00
F25.01	User function code 2	Range: F00.00~F25.xx	25.00
F25.02	User function code 3	Range: F00.00~F25.xx	25.00
F25.03	User function code 4	Range: F00.00~F25.xx	25.00
F25.04	User function code 5	Range: F00.00~F25.xx	25.00
F25.05	User function code 6	Range: F00.00~F25.xx	25.00
F25.06	User function code 7	Range: F00.00~F25.xx	25.00
F25.07	User function code 8	Range: F00.00~F25.xx	25.00
F25.08	User function code 9	Range: F00.00~F25.xx	25.00
F25.09	User function code 10	Range: F00.00~F25.xx	25.00
F25.10	User function code 11	Range: F00.00~F25.xx	25.00
F25.11	User function code 12	Range: F00.00~F25.xx	25.00
F25.12	User function code 13	Range: F00.00~F25.xx	25.00
F25.13	User function code 14	Range: F00.00~F25.xx	25.00
F25.14	User function code 15	Range: F00.00~F25.xx	25.00
F25.15	User function code 16	Range: F00.00~F25.xx	25.00
F25.16	User function code 17	Range: F00.00~F25.xx	25.00
F25.17	User function code 18	Range: F00.00~F25.xx	25.00
F25.18	User function code 19	Range: F00.00~F25.xx	25.00
F25.19	User function code 20	Range: F00.00~F25.xx	25.00
F25.20	User function code21	Range: F00.00~F25.xx	25.00
F25.21	User function code 22	Range: F00.00~F25.xx	25.00
F25.22	User function code 23	Range: F00.00~F25.xx	25.00
F25.23	User function code 24	Range: F00.00~F25.xx	25.00
F25.24	User function code 25	Range: F00.00~F25.xx	25.00
F25.25	User function code 26	Range: F00.00~F25.xx	25.00
F25.26	User function code 27	Range: F00.00~F25.xx	25.00

F25.27	User function code 28	Range: F00.00~F25.xx	25.00
F25.28	User function code 29	Range: F00.00~F25.xx	25.00
F25.29	User function code 30	Range: F00.00~F25.xx	25.00

This parameter is the User-defined parameter, user can choose the at most 30 from F0 to F30 that are reflect into F25, in order to check and alter more convenient.

Use F25.00 setting the first function code parameter that users plan to. then use F25.01 setting the second function code parameter that users plan to, so after the maximum 30 User-defined parameter that can define is finished, then setting F00.00=3(user list view, press ). If users want to drop out user-defined parameter mode, setting F00.00≠3, then press.

For example: user plan to set three User-defined parameter :F02.01,F03.02 和 F04.00 , following the steps below :

- (1)Use F25.00 to set the first function code parameter02.01, press  ;
- (2)Use F25.01 to set the second function code parameter03.02, press  ;
- (3)Use F25.02 to set the third function code parameter04.00, press  .
- (4)Set F00.00=3(user list view, press ).

After the setting is finished , if users do not change F00.00 function code, when enter function code display state, the operation panel will display F00.00,F02.01,F03.02 and F04.00 only, if the user do not want to display User-defined parameter, setting F00.00 to the display expected mode.



Note

1. xx represent function code.
- 2.F25.xx represent no reflection.



Note

When the setting function parameter is not available into the range of EN500/EN600 permit, setting the User-defined parameter will not make effective.

7.27 Fault Record Function Parameter Group: F26

F26.00	The last fault record	Range: 0~50	0
F26.01	The last two fault records	Range: 0~50	0
F26.02	The last three fault records	Range: 0~50	0
F26.03	The last four fault records	Range: 0~50	0

0:No fault.

1~26: E-01~E-26 fault.

27~29: Reserved.

30~39: E-30~E-39 fault.

40~50: Reserved.

F26.00~F26.03 definite the four times previous four code of faults and the two times previous fault for the voltage, current terminal and etc of inverter , users base on fault code and refer to fault function& fault handle process, then getting the results for different types of fault and reasons.

F26.04	Setup frequency at the last one fault	Range:0.00Hz~upper limit frequency	0.00Hz
F26.05	Output frequency at the last one fault	Range:0.00Hz~upper limit frequency	0.00Hz
F26.06	Output current at the last one fault	Range: 0.0~6553.5A	0.0A
F26.07	DC bus voltage at the last one fault	Range: 0.0~6553.5V	0.0V
F26.08	Module temperature at the last one fault	Range: 0~125℃	0℃
F26.09	Input terminal status at the last one fault		0
F26.10	Accumulated run time at the last one fault	Range: 0~65535min	0min
F26.11	Setup frequency at the last two fault	Range:0.00Hz~upper limit frequency	0.00Hz
F26.12	Output frequency at the last two fault	Range:0.00Hz~upper limit frequency	0.00Hz
F26.13	Output current at the last two fault	Range: 0.0~6553.5A	0.0A
F26.14	DC busbar voltage at the last two fault	Range: 0.0~6553.5V	0.0V
F26.15	Module temperature at the last two fault	Range: 0~125℃	0℃
F26.16	Input terminal status at the last two fault		0

F26.17	Accumulated run time at the last two fault	Range: 0~65535min	0min
---------------	---------------------------------------------------	--------------------------	-------------

F26.04~F26.17 record the running state of fault for the first and second time before, when Input terminal state at the fault, the terminal state is the whole terminal state after the time delay, including the standard input terminal state and expanded input terminal state .When Virtual terminal communication is set as the terminal panel point , the standard Input terminal state is determined by the actual physical input terminal and Virtual terminal communication .please refer to the details of the Input terminal state :

Bit0:X1(Standard input terminal 1). 1: valid;0: invalid
 Bit1:X2(Standard input terminal 2). 1: valid;0: invalid
 Bit2:X3(Standard input terminal 3). 1: valid;0: invalid
 Bit3:X4(Standard input terminal 4). 1: valid;0: invalid
 Bit4:X5(Standard input terminal 5). 1: valid;0: invalid
 Bit5:X6(Standard input terminal 6). 1: valid;0: invalid
 Bit6:X7(Standard input terminal 7). 1: valid;0: invalid
 Bit7:X8(Standard input terminal 8). 1: valid;0: invalid
 Bit8:EX1(Extended input terminal 1). 1: valid;0: invalid
 Bit9:EX2(Extended input terminal 2). 1: valid;0: invalid
 Bit10:EX3(Extended input terminal 3). 1: valid;0: invalid
 Bit11:EX4(Extended input terminal 4). 1: valid;0: invalid
 Bit12:EX5(Extended input terminal 5). 1: valid;0: invalid
 BIT13:EX6(Extended input terminal 6). 1: valid;0: invalid

7.28 Password and Manufacturer Function Parameter Group: F27



F27.00	User password	Range: 00000~65535	00000
--------	---------------	--------------------	-------

User password setting function is used for preventing unauthorized persons from checking and modifying the functional parameters.



Set F27.00 to 00000 if the user password function is unnecessary.

If user password function is necessary, input a 5-digit non-zero figure, and press  to confirm. The password is effective at once.

To change the password:

Press  and input the primary password, select F27.00 (F27.00=00000 at the moment), then input new password and press  to confirm. The password is effective at once.

To cancel the password:

Press  into the state of verification, and enter the original correct 5-digit password into the state of parameter editing, then select F27.00 (F27.00=00000 at the moment), and directly press  to confirm, the password can be canceled.



Note

Please memorize the password. Seeking advice from manufacturer in case it is lost.

F27.01	Manufacturer password	Range: 00000~65535	00000
--------	-----------------------	--------------------	-------

Factory setting function, the user can't modify.

8 Troubleshooting

8.1 Failure and countermeasure

Possible failure types in EN500/EN600 are shown in Table 8-1, the fault types including fault and alarm two kinds. Such as if inverter fault display E-XX, while the corresponding alarm is displayed in A-XX. Once the inverter failure, fault types are stored in the F26 fault recording parameter group, and if alarm, alarm status has been revealed, until the alarm source release, alarm status are not logged to the F26 parameter group. Some failure code is reserved for intelligent automatic diagnosis function which will be executed continuously in future. When failure takes place in the inverter, the user should check according to note of these table first and record failure phenomena detailedly. Please contact our after-sale service and technical support Department or agent in your local place when technical service is needed.

Table 8-1 Failure type and the countermeasure

Failure code	Failure type	Possible reason	Countermeasure
E-01	Overcurrent during accelerating process	Accelerating time is too short	Prolong accelerating time
		Improper V/F curve	Adjust V/F curve setting, adjust manual torque boost or change to automatic torque boost
		Restart rotating motor	Set speed checking restart function
		Low power source voltage	Check input power supply
		Too small power of the inverter	Choose inverter with high-power
		Output phase lose under vector control	Check whether the motor wiring is in good condition
E-02	Overcurrent during decelerating process	Decelerating time is too short	Prolong decelerating time
		Have potential energy load or big Inertia load	Increase braking power of external energy consumption braking subassembly
		Power of inverter is a bit small	Choose inverter with high-power
E-03	Overcurrent during constant speed process	Load change suddenly or have unwanted phenomena	Check or reduce saltation of the load
		Acc./Dec. time is set to too short	Prolong accelerating /decelerating time properly
		low power source voltage	Check input power supply
		Power of inverter is a bit small	Choose inverter with high-power
E-04	Overvoltage during accelerating process	Unwanted input voltage	Check input power supply
		Acc. time is set to too short	Prolong accelerating time properly

		Restart rotating motor	Set speed checking restart function
E-05	Overvoltage during decelerating process	Decelerating time is too short	Prolong decelerating time
		Have potential energy load or big inertia load	Increase braking power of external energy consumption braking subassembly
E-06	Overvoltage during constant speed process	Unwanted input voltage	Check input power supply
		Acc/Dec time is set to too short	Prolong accelerating decelerating time properly
		Input voltage change abnormally	Assemble reactor
		Load inertia is a bit big	Use energy consumption subassembly
E-07	Inverter control power supply overvoltage	Unwanted input voltage	Check input power supply or look for service
E-08	Low-voltage when running	Input voltage is too low	Check the input voltage
E-09	Inverter overload protection	Acc time is set to too short	Prolong accelerating time
		DC injection braking is too big	Reduce DC injection braking current, prolong braking time
		improper V/F curve	Adjust V/F curve and torque boost
		Restart rotating motor	Set speed checking restart function
		power source voltage is too low	check power source voltage
		Load is too big	Choose inverter with high-power
E-10 (A-10)	Motor overload protection	Improper V/F curve	Adjust V/F curve and torque boost
		Power source voltage is too low	check power source voltage
		General motor run at low speed with big load	Can choose frequency conversion motor for long time low speed run
		Motor overload protection factor set incorrectly	to set motor overload protection factor correctly
		Motor blocked up or load change too suddenly and quickly	Check the load
E-11 (A-11)	Motor underload protection	The operating current of inverter less than underload threshold	Confirm whether the parameters F19.08, F19.09 setting are reasonable
		load divorced from motor	Checking whether the load divorced from motor
E-12	The input phase lose	The three-phase input power supply is abnormal	Check the three-phase input power line is off or poor contact

		Power supply board anomaly	Look for service from manufacturer or agent
		The control board anomaly	Look for service from manufacturer or agent
E-13	The output phase lose	Anomaly wire between motor and inverter	Check the motor wire
		When the motor runs inverter three-phase output unbalanced	Check whether the motor three-phase winding is balance
		Power supply board anomaly	Look for service from manufacturer or agent
		The control board anomaly	Look for service from manufacturer or agent
E-14	Inverting module protection	Transient overcurrent of the inverter	Refer to countermeasure for overcurrent
		phase to phase short circuit or earthing short circuit of output 3 phase	wiring again
		Air-path blocked or fan damaged	To clear air-path or replace the fan
		Ambient temperature is too high	Lower ambient temperature
		Connecting wire or insert on control board loose	Check and connect the wire again
		Unwonted current wave caused by missing output phase etc.	Check wiring
		Assistant power supply damaged and drive voltage lacking	Look for service from manufacturer or agent
		Unwonted control board	Look for service from manufacturer or agent
E-15	Short circuit to ground when operation	Motor short circuit to ground	The replacement of cable or motor
		Hall component is damaged or the hall wiring is poor or the current detection circuit is abnormal	Look for service from manufacturer or agent
E-16	Short circuit to ground when power on	Motor short circuit to ground	Change the cable or motor
		The power supplier of the inverter and the motor wiring are reversed	Change the cable or motor wiring
		Hall component is damaged or the hall wiring is poor	Look for service from manufacturer or agent
E-17 (A-17)	Inverter overheat	Continuous alarm on A-17 for more than 30 minutes	Cleaning or to improve the ventilation duct
		Duct blockage	Cleaning or to improve the ventilation duct

		The ambient temperature is too high	To improve the ventilation conditions, decreasing the carrier frequency
		Fan damage	Change new one
		External fault emergency stop terminal closed	Open external failure terminal after external failure is settled
E-18 (A-18)	External device failure	Sudden stop terminal for external failure closed	Open external failure terminal after external failure is settled
E-19	Current detecting circuit failure	Connecting wire or insert on control board loose	Check and connect the wire again
		Assistant power supply damaged	Look for service from manufacturer or agent
		Hall component damaged	Look for service from manufacturer or agent
		Unwonted amplifying circuit	Look for service from manufacturer or agent
E-20	External interference failure	The interruption protection of CPU is triggered, but none of the actual overcurrent, overvoltage and short circuit signals have been detected	Press "STOP/RESET" button to reset or add external power supply filter from power input side
E-21	Internal interference failure	Internal disturbance serious	Power off and restart, if the failure persists, seek the manufacturer or dealer service
E-22 (A-22)	PID given loss	PID given loss threshold setting is not reasonable	To reset the relevant parameters
		External given disconnection	Check external given wiring
		The control board anomaly	Look for service from manufacturer or agent
E-23 (A-23)	PID feedback loss	PID feedback loss threshold setting is not reasonable	To reset the relevant parameters
		Feedback signal disconnection	Check external feedback signal wiring
		The control board anomaly	Look for service from manufacturer or agent
E-24 (A-24)	PID error amount abnormal	PID error abnormal detection threshold setting is not reasonable	To reset the relevant parameters
		The control board anomaly	Look for service from manufacturer or agent
E-25	Start terminal protection	Terminal command effective when power on .	Check the external input terminal state
E-26 (A-26)	Communication failure	Baud rate set improperly	set Baud rate properly
		Serial port communication error	Press "STOP/RESET" key to reset, look for service
		Failure warning parameter set improperly	Modify F05.04, F05.05

		Upper device doesn't work	Check if upper device work and wiring is correct
E-27	Reserved		
E-28	Reserved		
E-29	Reserved		
E-30 (A-30)	E ² PROM read and write wrongly	Mistake take place when read or write control parameter	Reset by pressing "STOP/RESET" Look for service from manufacturer or agent
E-31	Temperature detecting disconnection	Temperature sensor fault	Look for service from manufacturer or agent
		The temperature detection circuit anomaly	Look for service from manufacturer or agent
E-32	Self tuning failure	Parameter setting not according to the motor nameplate	set parameter correctly according to the motor nameplate
		current anomaly when tuning	Select inverter match the motor
		Motor wiring error	Check the motor three-phase wiring
E-33 (A-33)	Contactor anomaly	Power board anomaly	Look for service from manufacturer or agent
		Contactor anomaly	Replace contactor
E-34	The factory fault 1	Debugging use in factory	
E-35	The factory fault 2	Debugging use in factory	
E-36 (A-36)	The bus capacitor overheating	Poor cooling environment	Improve the inverter heat dissipation environment
		The inverter capacity is too small	Select inverter match motor
		Bus capacitance cooling fan is damaged	Replace the bus capacitor cooling fan
E-37	Encoder disconnection	Damaged encoder or poor wiring	Check the wiring or the encoder
E-38	Overspeed protection	Short acceleration time	Prolong the acceleration time
		Low inverter power	Select high-power inverter
		Overspeed detect parameter F19.39 and F19.40 is set improperly	Set the parameter properly according to the situation
E-39	Large speed deviation protection	Short Acceleration/ deceleration time	Prolong the acceleration time
		Low inverter power	Select high-power inverter
		Over velocity misalignment. Parameter F19.41 and F19.42 is set improperly	Set the parameter properly according to the situation
E-40 ~ E-50	Reserved		
A-51	The main and auxiliary given frequency channel exclusiveness alarm	Parameter setting error	F01.00 and F01.03 cannot be set to the same channel (9: terminal encoder given except)

A-52	Terminal function exclusiveness alarm	Terminal parameters setting repeatedly	function Check the terminal function settings
LOCH1.	Keypad lock	Keypad lock	The details, see 5.2.6 keypad lock operation

8.2 Failure record lookup

This series inverter can record latest 4 failure code and inverter run parameter of the last 2 times failure, refer to these information can redound to finding out reason of the failure.

Failure information is all stored in F26 group parameter, please enter into F26 group parameter to see about information by referring to keypad operation method.

Code	Content	Code	Content
F26.00	Previous one failure record	F26.09	Input terminal state at previous failure
F26.01	Previous two failure record	F26.10	Running time at previous failure
F26.02	Previous three failure record	F26.11	Set freq. at previous 2 failure
F26.03	Previous four failure record	F26.12	Output freq. at previous 2 failure
F26.04	Set freq. at previous failure	F26.13	Output current at previous 2 failure
F26.05	Output freq. at previous failure	F26.14	DC bus volt. at previous 2 failure
F26.06	Output current at previous failure	F26.15	Module temp. at previous 2 failure
F26.07	DC bus volt. at previous failure	F26.16	Input terminal state of previous 2 failure
F26.08	Module temp. at previous failure	F26.17	Running time of previous 2 failure

8.3 Failure reset



- 1. Before reset you must find out reason of failure downright and eliminate it, otherwise may cause permanent damage to the inverter.**
- 2. If can't reset or failure takes place again after resetting, should look for reason and continuous resetting will damage the inverter.**
- 3. Reset should take place 5 minutes later after overload, overheat protection action.**
- 4. For the fault of E-14, the reset is invalid, the motor wiring should be checked after power off, and restart the inverter.**
- 5. When there is a fault of E-16 after power on, do not directly run the inverter after reset, and need to check whether the input, out wiring are reversed.**

To resume normal running when failure takes place in the inverter, you can choose following any kind of operation:

- (1) After you set any terminal of X1~X8 to be inputted by external RESET, it will be reset after connected to COM.
- (2) When failure code is displayed, press  key after confirmed that it can be restoration.
- (3) Communication reset. Please refer to annex description.
- (4) Cut off power supply.

8.4 Alarm reset

When an alarm occurs, must eliminate alarm source which cause alarm, otherwise the alarm cannot be eliminated, also cannot be reset by reset button.

9 Maintenance

9.1 Routine maintenance

When you use this series you must assemble and operate it according to demand listed in this “service manual” strictly. During run state, temperature, humidity, vibration and aging parts will affect it, which may cause failure of the inverter. To avoid this, it is recommended to perform routine inspections and maintenance.

Table 9-1 Daily inspection and maintenance items

Period		Inspection item
Daily	Periodic	
√		Daily cleaning: (1) Inverter should be maintained in a clean state (2) Clean up the dust on the surface of inverter, prevent the dust into the inverter internal (especially metal dust). (3) Clean up the oil stain of cooling fan
	√	Check the air duct, and regularly clean.
	√	Check whether the screws is loose
	√	Check whether the inverter is corrode
√		Whether inverter installation environment changes
√		Whether the inverter cooling fan is working properly
√		Whether the inverter is overheating
√		When running whether voice of motor abnormal change.
√		Whether occur abnormal vibration when motor running
	√	Check wiring terminals have arc trace
	√	The main circuit insulation test

Recommend to inspect with following instrument:

Input voltage: electric voltmeter; output voltage: rectifying voltmeter; input output current: pincers ammeter.

9.2 Inspection and replacement of damageable parts

Some component parts in the inverter will be abraded or bear descending performance for long-term usage, to assure that the inverter can run stably and reliably, it is recommended to perform defending maintenance and replace corresponding parts if necessary.

(1) Cooling fan

Abnormal noise, even oscillation may take place if the fan have wearing bearing, aging blade, here replacement of the fan should be considered.

(2) Filter electrolyte capacitance

When frequent-changing load causes increasing pulsant current and aging electrolyte under high ambient temperature, the electrolyte capacitance may be damaged and here should replace it.

9.3 Repair guarantee

(1) We provide the free maintenance within warranty time if any failure or damage under normal usage, the warranty time can be seen in the warranty card, we will charge some when exceed warranty time.

(2) We will take some upkeep if one of following situations takes place within period of repair guarantee.

- a. If did not use the inverter according to *service manual* strictly or did not use it under ambient demanded in *service manual*, which cause failure.
- b. Failure caused by applying the inverter to non-normal function;
- c. Failure caused by self-repair, refit which is not already allowed;
- d. Damage caused by bad keeping, falling down from high place or other extrinsic factor after purchasing the inverter;
- e. Failure caused by natural disaster or its reason such as unwonted voltage, thunderbolt, water fog, fire, salt corroding, gas corroding, earthquake and storm etc.;
- f. Make bold to tear up product logo (such as: nameplate etc.); Body serial number don't accord with that in repair guarantee card.

(3) We calculate service fee based on actual cost, which is subject to contract if any.

(4) You can contact the agent and also our company directly if you have questions. After repair guarantee period, we shall also provide lifetime charged repair service for our products.



Note

Our company will also provide lifetime repair service with fee for inverter which is not within period of repair guarantee.

9.4 Storage

The user must pay attention to following points for temporary storage and long-term storage after purchasing the inverter:

- (1) Avoid storing the inverter in high temperature, moist place and place of dust, metal powder and assure good ventilation.
- (2) Longtime storage will cause low quality of electrolyte capacitance, so must assure that it's electrified for one time within 1 year and electrification time is not shorter than 1 hour and input voltage must be increased to rated value gradually by voltage regulator of 250w, meanwhile the inverter should be cut off from the motor.

Appendix A Modbus communication protocol

A.1 Summary

We provide general RS485 communication interface in our inverters for the user. Through this communication interface upper device (such as HMI, PC, PLC controller and etc.) can perform centralized monitor to the inverter (such as to set inverter parameter, control run of inverter, read work state of the inverter).

This communication protocol is interface criterion file designed for realizing above-mentioned function, please read it earnestly and program according to it so that realize long-distance and network control to the inverter.

A.2 Communication net buildup mode

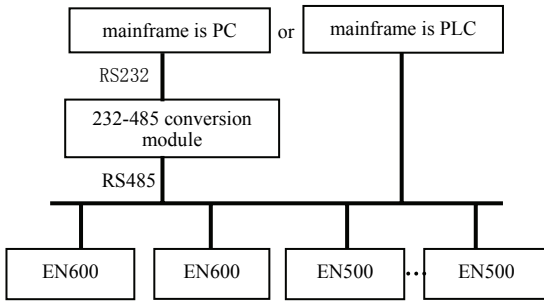

Fig.A-1 net buildup graph

A.3 Communication mode

At present, EN500/EN600 inverter can be used only as Slave device in RS485 net. Can realize communication between inverters through PC, PLC or HMI if it's needed. Specific communication mode is as mentioned below:

- (1) PC or PLC as mainframe, inverter as Slave device, point-to-point communication between mainframe and Slave device.
- (2) Slave device don't response when mainframe send out command by broadcast address.
- (3) User can set local address, baud rate and data format of the inverter through Slave device keypad or serial communication mode.
- (4) EN500/EN600 provides the RS485 interface.
- (5) Default mode: Asynchronous serial, semiduplex transport mode. There are RTU and ASII two mode . Default format and transport rate: 8-N-1, 9600bps.

A.4 Transmission mode

Asynchronous serial, semiduplex transport mode. Default format and transport rate: 8-N-1, 9600bps. The detail setting parameter, please refer to the F05 group function mode.

(Remark: the parameter is valid under the Modbus communication, the other parameter comply with the original service manual)

F05.00	Protocol selection	0:Modbus protocol 1:Reserved 2:Profibus protocol(expansion is valid) 3:CanLink protocol(expansion is valid) 4:CANopen protocol(expansion is valid) 5:free protocol 1(revision all the parameter of EN500 is valid) 6: free protocol 2(only revising part parameter of EN500 is valid) Remark: expansion card is needed when select 2,3,4 communication	1	0	×
F05.01	Baud rate setting	The unit digital: free protocol and Modbus Baud rate selection 0:300BPS 1:600BPS 2:1200BPS 3:2400BPS 4:4800BPS 5:9600BPS 6:19200BPS 7:38400BPS 8:57600BPS	1	005	×
F05.02	Data format	LED the unit digital: free protocol and Modbus protocol Data format 0:1-8-1 format, no checkout, RTU 1:1-8-1 format, Odd Parity, RTU 2:1-8-1 format, Even Parity, RTU 3:1-7-1 format, no checkout, ASCII 4:1-7-1 format, Odd Parity, ASCII 5:1-7-1 format, Even Parity, ASCII		00	×
F05.03	Local address	0~247, 00 is broadcast address	1	1	×

A.5 Data communication structure

A.5.1 Data frame format

Using RTU mode, messages are sent at least 3.5 character time interval pause. The first transmitted field is device address, the character you can transfer is hexadecimal 0x00 ~ 0xFF. Network equipment continuously monitor the bus, including pauses. When the address field is received, all equipment determine whether it is sent to their own. when the last character of the packet transfer is complete, at least a 3.5 character times pause mean the end of the message. A new

message can begin after this pause.

The entire message frame must be transmitted as a continuous flow. If a new message start transmitting in less than 3.5 character times after a message and then receiving device will consider it a continuation of the previous message. This will cause an error, because in the final CRC field value can not be right.

RTU frame format as the table below:

Frame Header	3.5 characters time pause
Slave address	Slave address:0~247
Communication command code	03H:read slave parameter 06H:write slave parameter
Data content DATA	The contents of packet: Parameter address(16bit); Number of parameter or bytes of parameter value; Parameter value(16bit)
Data content DATA	
.....	
.....	
CRC check value low byte	16bit Unsigned check value
CRC check value high byte	
Closing Flag	3.5 characters time pause

Regarding generation method of CRC check value, please refer to Section A.9.

ASCII frame format as the table below:

Frame Header	‘:’(0x3A)
Slave address Hi	Slave address: Combined by 2 ASCII code
Slave address Lo	8 bit slave address 0~247
Command code Hi	Command code: 8 bit command code combined by 2 ASCII code
Command code Lo	03H:read slave parameter 06H:write slave parameter
Data content DATA	The contents of data packet:
Data content DATA	N pieces of 8bit data content combined by 2*N pieces of ASCII code
.....	
.....	
LRC CHK Hi	LRC check value includes 2 pieces of ASCII code
LRC CHK Lo	
Closing Flag Hi	Closing Flag Hi = CR(0x0D)
Closing Flag Lo	Closing Flag Lo = LF(0x0A)

A.5.2 Host read slave parameter

Command code 03H. Host can read one or more parameter(up to ten) by initiating a communication transaction .

E.g., read 2 contiguous inverter parameter values from the address 0000H of inverter whose address is 01, the contents of host command :

ADR	01H
CMD	03H
Parameters initial address high byte	00H
Parameters initial address low byte	00H
Number of parameter high byte	00H
Number of parameter low byte	02H
CRC check value low byte	C4
CRC check value high byte	0B

The contents of slave reply:

ADR	01H
CMD	03H
Parameter value bytes	04H
Address 0000H content high byte	00H
Address 0000H content low byte	00H
Address 0001H content high byte	00H
Address 0001H content low byte	03H
CRC check value low byte	BA
CRC check value high byte	F2

A.5.3 Host write slave parameter

Command code 06H. Host can write an parameter by initiating a communication transaction .

E.g.,The decimal system 5000 (1388H) written to the inverter 0101H address whose slave address is 02, host command including:

ADR	02H
CMD	06H
Parameter address high byte	01H
Parameter address low byte	01H
Parameter value high byte	13H
Parameter value low byte	88H
CRC check value low byte	D4
CRC check value high byte	93

The contents of slave reply:

ADR	02H
CMD	06H
Parameter address high byte	01H
Parameter address low byte	01H
Address 0101H content high byte	13H
Address 0101H content low byte	88H
CRC check value low byte	D4
CRC check value high byte	93

A. 6 Data communication address allocation

A.6.1 Function code F00-F26 group communication address

Inverter function parameter's MODBUS communication address addressing process follows PPnn way: PP means high byte of the address, corresponding to function parameter's group number; nn means low byte of the address, corresponding to function code parameter's group internal code. For example: F3.21 function code's communication address is 0315H, 03H is the hex form of group number 3, 15H is the hex form of group internal code 21.

F00.00~F26.17 communication address is 0000H~1A11H, F26 group fault record parameter start address is 1A00H.

A.6.2 control command and status word communication address

Variable Name	Communication address	Reading-writing attribute	Command data or response value meaning
Run command word	1E 00H	Reading and writing	1: reserved
			2: reserved
			3: forward JOG run
			4: reversal JOG run
			5: run
			6: stop
			7: forward run
			8: reversal run
			9: fault reset
			10: reserved
Serial port value setting	1E 01H	Reading and writing	0~10000(0~max)
Inverter status	1E 02H	Reading only	BIT0: bus voltage set BIT1: the ordinary run command effectively BIT2: JOG command effectively BIT3: Running BIT4: the current running direction is reverse BIT5: the operating instructions is reverse direction BIT6: deceleration braking BIT7: acceleration BIT8: deceleration BIT9: alarm BIT10: fault BIT11: current limit BIT12: fault self recovery BIT13: self tuning BIT14: Free stop State BIT15: speed tracking start

Alarm code	1E 03H	Reading only	0: no alarm 1 ~ 50: the current alarm code
------------	--------	--------------	-----------------------------------------------



Note

Modbus communication address 1E01(frequency given) can be torque setting and pressure setting address

A.6.3 Monitor parameter communication address

Variable name	Communication address	read-write attribute	Command data or response value
C-00	1C00H	Reading	Monitoring parameters 1
C-01	1C01H	Reading	Monitoring parameters 2
C-02	1C02H	Reading	Monitoring parameters 3
C-03	1C03H	Reading	Monitoring parameters 4
C-04	1C04H	Reading	Monitoring parameters 5
C-05	1C05H	Reading	Monitoring parameters 6

A.6.4 Inside hidden parameters

Variable name	Communication address	read-write attribute	means of command data or response value
Reserved	1D00H	/	
Reserved	1D01H	/	
Communication AO1 given value	1D02H	read-write	Range: 0~4000
Communication AO2 given value	1D03H	read-write	Range: 0~4000
Communication EAO1 given value	1D04H	read-write	Range: 0~4000
Communication EAO2 given value	1D05H	read-write	Range: 0~4000
Communication DO given value	1D06H	read-write	Range: 0~4000
Communication EDO given value	1D07H	read-write	Range: 0~4000
The communication output terminal given value	1D08H	read-write	BIT0:Y1 BIT1:Y2 BIT2:Y3 BIT3: Y4 BIT4: RLY BIT5: EY1 BIT6: EY2 BIT7: EY3 BIT8: EY4 BIT9: ERLY1 BIT10: ERLY2
Communication	1D09H	read-write	BIT0: CX1

virtual input terminal given value			... BIT7: CX8
Reserved	1D0AH	/	
Reserved	1D0BH	/	
Reserved	1D0CH	/	
Reserved	1D0DH	/	

A.7 Communication error processing

Inverter receiving data packet detection error, it finds reading&writing parameter address or parameter value invalid, so reply to the host with communication error response packet. Communication error response packet (host command code +80H) as command code, with 1 byte error code.

Format for communication error response packet as follows:

ADR	01H
CMD	83H/86H
Communication error code	01H~06H (for details, please check below table)
Low byte of CRC checksum	Obtain by calculating
High byte of CRC checksum	Obtain by calculating

Meaning for each communication error code value as follows:

Communication error code value	Communication error type	Priority
0x01	CRC checksum error	1
0x02	Command code illegal	2
0x03	Register address visited illegal	3
0x04	Value to register illegal	4
0x05	Not allow to modify parameters	5
0x06	Register number read illegal	6

A.8 Data frames examples

A.8.1 RTU Mode

1. Start #1 inverter running

Data Field	Slave Address	Order code	Register address High byte	Register address Low byte	Data High byte	Data Low byte	CRC low bit	CRC high bit
host command frames	01	06	1E	00	00	05	4F	E1
Slave respond frames	01	06	1E	00	00	05	4F	E1

2. Stop #1 inverter running

Data Field	Slave Inverter Address	Order code	Register address High byte	Register address Low byte	Data High byte	Data Low byte	CRC Low bit	CRC High bit
host command frames	01	06	1E	00	00	06	0F	E0
Slave respond frames	01	06	1E	00	00	06	0F	E0

3. Set #1 inverter given value to 25Hz (the upper limitation frequency is 50Hz)

Data Field	Slave Inverter Address	Order code	Register address High byte	Register address Low byte	Data High byte	Data low byte	CRC low bit	CRC high bit
host command frames	01	06	1E	01	13	88	D3	74
Slave respond frames	01	06	1E	01	13	88	D3	74

4. Read #1 inverter running state

Data Field	Slave Inverter Address	Order code	Register address High byte	Register address Low byte	Data High byte	Data low byte	CRC low bit	CRC high bit
host command frames	01	03	1E	02	00	01	23	E2
Slave respond frames	01	03	(Respond value byte quantity) 02		00	01	79	84

A.8.2 ASCII Mode

Host read Slave, command code: 03

The host frame

The host frame format																		
	Frame begin symbol	Slave address	Slave address	Command code	Command code	Register address	Register address	Register address	Register address	Register number	Register number	Register number	Register number	Register number	Register number	Checksum	checksum	Ending symbol
Send byte	1	2		2		4				4				2		2		

Remark:

➤ **Begin symbol:**

The lower computer judge the frame header of ASCII based on this.

It is:’?’

➤ **Slave address:**

Single inverter ID code, range:0~247.

Thereinto, 0 is broadcast address. Broadcast address can control all the lined Slave simultaneously, and the Slave will not send back any Data to the host. That means the Slave only accept and do not send.

Modbus protocol without host address.

➤ **Command code:**

Reading the command of parameter or data from inverter , the value is:’0’3’.

➤ **Register address:**

The internal memory address of inverter function parameter is of 4 byte, which is ASCII mode transformed from Hexadecimal.

Corresponding relation between specific parameters and memory address can be seen in the later table.

➤ **Register number:**

The number of parameters read by a frame, it is 4 byte. It is ASCII mode transformed from Hexadecimal.

➤ **Checksum:**

From “slave address” to the character before checksum, the LRC checksum of the character string. Function terminal can be seen on the end of the text.

- **Ending code:** enter, line break. is:0x0D,0x0A

Response frame

Response frame format												
	Frame begin symbol	Slave address	Slave address	Slave code	Command code	Command	Data byte	Data byte	Data string value	checksum	checksum	Ending code
Send byte	1	2			2		2		N*2	2		2

remark:

- **Begin code:**
The lower computer judge the frame of ASCII frame. This is ':'.
- **Slave address:**
Single inverter ID code, range:0~247.
Thereinto, address 0 is broadcast address. Broadcast address can control all the lined Slave simultaneously, and the Slave will not send back any Data to the host. That means the Slave only accept and do not send.
Modbus protocol is without host address.
- **Command code:**
The command of reading parameter or data from inverter, the value is:'0'3'.
- **Data byte:**
The number of parameters read by a frame. It is 4 byte, which is ASCII mode transformed from hexadecimal.
- **Data string value:**
The detail return Data, the length of Data string is the register address "Data byte", which is ASCII mode transformed from hexadecimal. Range: 4~40 byte
- **Checksum:**
From "slave address" to the character before checksum, the LRC checksum of the character string.
The function terminal can be seen in the later text.
- **Ending symbol:** enter, line break. Is 0x0D,0x0A
The followings are the example of command frame and return frame, all the Data are ASCII character.

➤ **Inquiry frame:**

: 0 1 0 3 0 0 0 1 0 0 0 1 F A \n\r

(The detail introduction of every byte)

“:”: beginning symbol

0 1: Slave address

0 3:read the command

0 0 0 1:storage address of reading parameter

0 0 0 1:the number of reading the parameter

F A:{ 0 1 0 3 0 0 0 1 0 0 0 1 } for LRC checksum.

0xFA = 0x100 - (0x01 + 0x03 + 0x00 + 0x01 + 0x00 + 0x01)

➤ **Response frame:**

: 0 1 0 3 0 2 0 0 3 3 C 7 \n\r

(The detail introduction of every byte)

“:”: beginning symbol

0 1: Slave address

0 3:read the command

0 2:The byte length of return parameter Data.

0 0 3 3:return parameter, current storage value

C 7:{ 0 1 0 3 0 2 0 0 3 3 } for LRC checksum.

0xC7 = 0x100 - (0x01 + 0x03 + 0x02 + 0x00 + 0x33)

The main frame writes slave address single register, command code: 06

The host frame

The host frame format																
	Frame begin symbol	Slave address	Slave address	Slave address	Command code	Register address	Register address	Register address	Register address	Data	Data	Data	Data	Checksum	checksum	Ending symbol
Send byte	1	2		2		4				4				2		2

Remark:

➤ **Slave address:**

Single inverter ID code, range:0~247.

Thereinto, address 00 is broadcast address.

➤ **Command code:**

Read parameter from inverter or command of Data, the value is:06

➤ **Register address:**

The storage address of inverter function parameter, is double byte.

The high byte is in the front and the low byte is in the back.

The detail relation between parameter and storage address can be seen in the later excel.

➤ **Data:**

The new value of revised parameter.

➤ **Checksum:**

From “slave address” to the character before checksum, the LRC checksum of the character string.

Response frame

Response frame format																
	Frame begin symbol	Slave address	Slave address	Command code	Command code	Register address	Register address	Register address	Register address	Data	Data	Data	Data	Checksum	Checksum	Ending symbol
Send byte	1	2	2	1	1	2	2	2	2	4	4	4	4	2	2	2

Remark:

➤ **Slave address:**

Single inverter ID code, range:0~247.

Thereinto, address 00 is broadcast address.

➤ **Command code:**

Read parameter from inverter or command of Data, the value is:06

➤ **Register address:**

The storage address of inverter function parameter, is double byte.

The high byte is in the front and the low byte is in the back.

The detail relation between parameter and storage address can be seen in the later excel.

➤ **Data:**

The new value of revised parameter.

➤ **Checksum:**

From “slave address” to the character before checksum, the LRC checksum of the character string.

The followings are the example of command frame and return frame, all the Data are ASCII character.

➤ **Inquiry frame:**

:0106010113885C\r\n

(The detail introduction of every byte)

“.”: beginning symbol

0 1: Slave address

0 6:write command

0 1 0 1:storage address of writing parameter

1 3 8 8:the value of writing parameter

5 C:{ **0 1 0 6 0 1 0 1 1 3 8 8**} for LRC checksum.

0x5C = 0x100 - (0x01 + 0x06 + 0x01 + 0x01 + 0x13 + 0x88)

➤ **Response frame:**

: 0 1 0 6 0 1 0 1 1 3 8 8 5 C \n\r

(Detail introduction of every byte)

“.”: beginning symbol

0 1: Slave address

0 6:write command

0 1 0 1:storage address of writing parameter

1 3 8 8:the value of writing parameter

5 C:{ **0 1 0 6 0 1 0 1 1 3 8 8**} for LRC checksum.

0x5C = 0x100 - (0x01 + 0x06 + 0x01 + 0x01 + 0x13 + 0x88)



Note

1. ASCII frame realizes transform by that 8Bit hexadecimal is divided as different 2 character of 4, and then grouped as hexadecimal of one 8Bit when reaching the destination.
2. Frame header, add“.”, frame footer adds“\n\r” the enter line break character.
3. The valid character in the protocol is: ., 0,1,2,3,4,5,6,7,8,9,A,B,C, D,E,F and hexadecimal 0DH, lower case ASCII letter a, b, c, d, e, f is invalid
4. The subject data volume is the 2 times as RTU, checksum adopt LRC check.
5. For the other information, please refer to the official standard protocol when need.

A.9 CRC checkout mode

CRC checkout value calculating function written by C language is as follows:

```
unsigned int cal_crc_value (unsigned char *pval, unsigned char len)
{
    unsigned int crc_value=0xFFFF;
    unsigned int i;

    while(len--)
    {
        crc_value ^= *pval++;
        for(i=0; i<8; i++)
        {
            if(crc_value & 0x0001)
            {
                crc_value >>= 1;
                crc_value ^= 0xA001;
            }
            else
            {
                crc_value >>= 1;
            }
        }
    }
    return(crc_value);
}
```

Appendix B Free-port communication protocol

B.1 Summarization

We provide the customer with general RS485/RS232 communication interface in our EN500/EN600 series frequency inverter. For the users, through the communication interface upper device (such as PC, PLC controller etc.) can perform centralized monitor to the inverter (such as setting inverter parameter, controlling run of inverter, reading work state of the inverter) and also long-distance control keypad can be connected to realize diverse operating requirement of the user.

This communication protocol is interface criterion file designed for realizing above-mentioned function, please read it earnestly and program according to it so that realize long-distance and network control to the inverter.

B.2 Protocol content and description

B.2.1 Communication net buildup mode

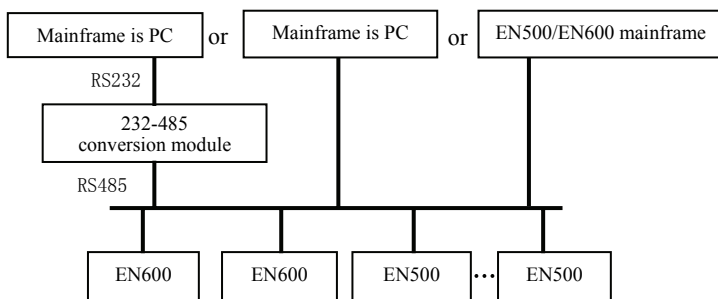

Fig.B-1 net buildup graph

B.2.2 Communication mode

At present, EN500/EN600 inverter can be used as not only auxiliary device but also mainframe device in RS485, if the inverter is used as auxiliary device, master device can be completed by PC, PLC or human interface, and if used as mainframe device, the main- auxiliary control of the inverter can be complement by it. Specific communication mode is as mentioned below:

- (1) PC or PLC as mainframe, inverter as auxiliary device, point-to-point communication between mainframe and auxiliary device.
- (2) Auxiliary device don't response when mainframe send out command by broadcast address.
- (3) User can set local address, baud rate and data format of the inverter through auxiliary device keypad.

- (4) Auxiliary device report current failure information to mainframe in the last response frame.
- (5) EN500/EN600 provides RS485 interface.

B.2.3 Transport mode

Asynchronous serial, semiduplex transport mode. Default format and transport rate: 8-N-1, 9600bps. For specific parameter setting please see description for F05 group function code.

(Remark: The definition for this parameter is only effective under free –port communication mode, and definition for other parameters are the same as original)

F05.00	Protocol selection	0:Modbus protocol 1:reserved 2:Profibus protocol(extension effective) 3:CanLink protocol(extension effective) 4:CANopen protocol(extension effective) 5:freedom protocol 1(can modify all function parameters of EN500/EN600) 6:freedom protocol 2 (can only modify part of function parameter of EN500/EN600) Remark: expansion card is needed if select protocol 2, 3, 4	1	0	×
F05.01	Baud rate configuration	LED first bit: freedom protocol and Modbus baud rate selection 0:300BPS 1:600BPS 2:1200BPS 3:2400BPS 4:4800BPS 5:9600BPS 6:19200BPS 7:38400BPS 8:57600BPS	1	005	×
F05.02	Data format	LED first bit: freedom protocol and Modbus protocol data format 0:1-8-1 format, no checkout, RTU 1:1-8-1 format, even checkout, RTU 2:1-8-1 format, odd checkout, RTU 3:1-7-1 format, no checkout, ASCII 4:1-7-1 format, even checkout, ASCII 5:1-7-1 format, odd checkout, ASCII		00	×
F05.03	Local address	0~247, 00 is master station address	1	1	×

B.2.4 Data command frame format

Main device command frame format																		
Sending order	1	2	3	4	5	6	7	8	9	10	11	12	13	14	15	16	17	18
	frame head	auxiliary device address	auxiliary device address	main device command	main device command	assistant index	assistant index	command index	command index	set data	set data	set data	set data	check out sum	check out sum	check out sum	check out sum	frame end
Definition	head	address		command area		Index area				Setting data area				check out area			end	
Sending byte	1	2		2		4				4				4			1	

Auxiliary device response frame format																		
Sending order	1	2	3	4	5	6	7	8	9	10	11	12	13	14	15	16	17	18
	frame head	auxiliary device address	auxiliary device address	auxiliary device response	auxiliary device response	failure index	failure index	command index	command index	run data	run data	run data	run data	check out sum	check out sum	check out sum	check out sum	frame end
Definition	head	address		response area		Index area				Run data area				Check out area			end	
Sending byte	1	2		2		4				4				4			1	

Fig.B-2 command/response frame format

Remark:

(1) “Setting data area” and “run data area” may not be existent in some command/data frame format, so in protocol command list it’s marked with “nothing”.

(2) In protocol effective character set is: ~, 1, 2, 3, 4, 5, 6, 7, 8, 9, A, B, C, D, E, F and hex data 0DH, ASCII lowercase a, b, c, d, e, f are invalid.

(3) Effective command frame length is 14 or 18 byte.

B.2.5 Explanation and description for format

(1) Frame head

It’s character“~” (namely hex 7E), single byte.

(2) Auxiliary device address

Data meanings: local address of auxiliary device, double byte. ASCII format.

Inverter factory default is 01.

(3) Mainframe command/auxiliary device respond

Data meanings: mainframe send out command and auxiliary device respond to the command. Double byte, ASCII format.

Response code function classification:

Species 1>: command code=“10”, mainframe ask auxiliary device to report current preparation state and control situation.

Table B-1 Command code meanings for response frame response area

Response code ASCII	Meanings		
	Preparation state of auxiliary device	Control from mainframe is allowed	To set frequency is allowed
10	Haven't get ready	No meaning	
11	Get ready	Allow	Allow
12	Get ready	Allow	Allow
13	Get ready	Don't allow	Don't allow
14	Get ready	Don't allow	Don't allow
20	Frame error		

Species 2>: command code=“11”~“15”, 5 kinds of function command which mainframe send to auxiliary device, for detail please see protocol command list.

Table B-2 Response code meanings for response frame command index area

Response code ASCII	Meanings of response code	Description
00	Auxiliary device communication and control is normal ; function code modification is effective; password is correct.	
20	(1) frame checkout error; (2)"command area" data overrun; (3)"index area" data overrun; (4)frame length error/non ASCII byte exist in area except frame head, frame end.	When this response code is reported, data of "command area", "index area" and "running data area" are not reported.
30	(1) control to auxiliary device is ineffective; (2) ineffective function code parameter modification; (3)"setting/running data" area data overrun. (4) password error.	Whether report this response code relate to current set state of auxiliary device. When report data of area", "index area" and "run data area" are reported according to protocol requirement.

(4) Auxiliary index/command index/failure index

Data meanings: include auxiliary index byte and command index byte.

For mainframe, auxiliary index, command index are used for cooperating mainframe command in realizing specific function.

For auxiliary device, auxiliary index, command index are used for reporting failure state code, command index are reported without modification

Data type: hex, 4 byte, ASCII format.

Command index occupy 2 low byte, data range: "00"~"FF".

Auxiliary index occupy 2 high byte, data range: "00"~"FF".

Auxiliary device failure state occupy "auxiliary index" byte, see table B-3.

Table B-3 Free-port1 failure type description

Failure code(decimal)	Description	Failure code(decimal)	Description
1	Overcurrent during accelerating process	19	Current detecting circuit failure
2	Overcurrent during decelerating process	20	External interference failure
3	Overcurrent during constant speed process	21	Internal interference failure
4	Overvoltage during accelerating process	22	PID provision loss
5	Overvoltage during decelerating process	23	PID feedback loss
6	Overvoltage during constant speed process	24	PID error amount exception

7	Overvoltage while halting	25	Startup terminal protection
8	Under voltage during running process	26	RS485 communication failure
9	Inverter overload protection	27	Reserved
10	Motor overload protection	28	Reserved
11	Motor underload protection	29	Reserved
12	Input phase missing	30	E ² PROM read and write wrongly
13	Output phase missing	31	Temperature detection breakage
14	Inverting module protection	32	Self-tuning failure
15	Short circuit to earth during running process	33	Contactors exception
16	Short circuit to earth during electrifying process	34	Interior failure 1
17	Inverter over heating		
18	External device failure		

Free-port 2 failure type description

Failure code(decimal)	Description	Failure code(decimal)	Description
1	Overcurrent during accelerating process	13	Inverting module protection
2	Overcurrent during decelerating process	14	External device failure
3	Overcurrent during constant speed process	15	Current detecting circuit failure
4	Overvoltage during accelerating process	16	RS485 communication failure
5	Overvoltage during decelerating process	17	Reserved
6	Overvoltage during constant speed process	18	Reserved
7	Control power supply overvoltage	19	Under voltage
8	Inverter overload	20	System interference
9	Motor overload	21	Reserved
10	Inverter over heating	22	Reserved

11	Reserved	23	E ² PROM read and write wrongly
12	Reserved		

(5) Checkout sum

Data meanings: frame checkout, 4 byte, ASCII.

Calculation method: accumulative sum of ASCII code value of all byte from “auxiliary device address” to “run data”.

(6) Frame end

Hex 0D, single byte.

B.2.6 Protocol command list

Frame 7E and frame end 0D, address, checkout sum, ASCII character format are omitted in following description.

Table B-4 Free-port 1 protocol command table

Name		Mainframe order Decimal	Auxiliary index Hex	Order index Hex	Run data setting range Hex	Mainframe sending example, such as PC control operation of inverter (C language cluster format, auxiliary device is set to 01)	Run data precision	Description
Look up auxiliary motor state		10	00	00	no	~010A00000192r	1	
Read parameter of auxiliary motor	Main setting frequency	11	00	00	no	~010B00000193r	0.01Hz	
	Auxiliary setting frequency	11	00	01	no	~010B00010194r	0.01Hz	
	Setting frequency	11	00	02	no	~010B00020195r	0.01Hz	
	Output frequency	11	00	03	no	~010B00030196r	0.01Hz	
	Output current	11	00	04	no	~010B00040197r	0.1A	
	Output voltage	11	00	05	no	~010B00050198r	1V	
	DC bus-bar voltage	11	00	06	no	~010B00060199r	0.1V	
	Load motor revolving speed	11	00	07	no	~010B0007019A\	1RPM	
	Load motor linear speed	11	00	08	no	~010B0008019B\	no	
	Inverter temperature	11	00	09	no	~010B0009019C\	1℃	
	Runtime	11	00	0A	no	~010B000A01A4r	0.1min	
	Current accumulative runtime	11	00	0B	no	~010B000B01A5r	1h	
	Current accumulative power-on time	11	00	0C	no	~010B000C01A6r	1h	
Inverter state	11	00	0D	no	~010B000D01A7\	no		
Input terminal state	11	00	0E	no	~010B000E01A8\	no		

Output terminal state	11	00	0F	no	~010B000F01A9r	no	
Expand output terminal state	11	00	10	no	~010B00100194r	no	
Expanding input terminal state	11	00	11	no	~010B00110195r	no	
Communicational virtual input terminal state	11	00	12	no	~010B00120196r	no	
Internal virtual input node state	11	00	13	no	~010B00130197r	no	
Analog input A11	11	00	14	no	~010B00140198r	no	
Analog input A12	11	00	15	no	~010B00150199r	no	
Expanding analog input EAI1	11	00	16	no	~010B0016019A'r	no	
Expanding analog input EAI2	11	00	17	no	~010B0017019B'r	no	
Analog AO1 output	11	00	18	no	~010B0018019C'r	no	
Analog AO2 output	11	00	19	no	~010B0019019D'r	no	
Expanding analog EAO1 output	11	00	1A	no	~010B001A01A5'r	no	
Expanding analog EAO2 output	11	00	1B	no	~010B001B01A6'r	no	
External pulse input frequency	11	00	1C	no	~010B001C01A7'r	1Hz	
Reserved							
Process PID provision	11	00	1E	no	~010B001E01A9'r	0.01V	
Process PID feedback	11	00	1F	no	~010B001F02AA'r	0.01V	
Process PID error	11	00	20	no	~010B00200195'r	0.01V	
Process PID output	11	00	21	no	~010B00210196'r	0.01Hz	
Simple PLC current segments	11	00	22	no	~010B00220197'r	no	
External multi-section speed current segments	11	00	23	no	~010B00230198'r	no	
Provision pressure for constant pressure water	11	00	24	no	~010B00240199'r	0.001Mpa	
Feedback pressure for constant pressure water	11	00	25	no	~010B0025019A'r	0.001Mpa	
Relay state for constant pressure water	11	00	26	no	~010B0026019B'r	no	
Current length	11	00	27	no	~010B0027019C'r	no	
Accumulative length	11	00	28	no	~010B0028019D'r	no	
Current internal count	11	00	29	no	~010B0029019E'r	no	
Current internal time	11	00	2A	no	~010B002A01A6'r	no	
Setting channel for run command	11	00	2B	no	~010B002B01A7'r	no	
Main frequency provision channel	11	00	2C	no	~010B002C01A8'r	no	
Auxiliary frequency provision channel	11	00	2D	no	~010B002D01A9'r	no	
Inverter rated current	11	00	2E	no	~010B002E01AA'r	0.1A	
Inverter rated voltage	11	00	2F	no	~010B002F01AB'r	1V	
Inverter rated power	11	00	30	no	~010B00300196'r	0.1KW	

	Reserved							
	Reserved							
	Frequency after acceleration and deceleration	11	00	33	no	~010B00330199\r	0.01Hz	
	Motor rotor frequency	11	00	34	no	~010B0034019A\r	0.01Hz	
	Current provision torque	11	00	35	no	~010B0035019B\r	0.1%	
	Current output torque	11	00	36	no	~010B0036019C\r	0.1%	
	Current torque current	11	00	37	no	~010B0037019D\r	0.1A	
Current flux current	11	00	38	no	~010B0038019E\r	0.1A		
Run control and adjusting function	Auxiliary device run command	12	00	00	no	~010C00000194\r	no	
	Set current run frequency provision of auxiliary device	12	00	01	0Hz~high limit freq	~010C00010FA0027C\r	0.01Hz	Set freq. =40.00Hz
	Auxiliary device run with run frequency provision	12	00	02	0Hz~high limit freq	~010C00020FA0027D\r	0.01Hz	Auxiliary device run Set freq. =40.00Hz
	Auxiliary device forward run	12	00	03	no	~010C00030197\r	no	
	Auxiliary device reverse run	12	00	04	no	~010C00040198\r	no	
	Auxiliary device forward run with run frequency provision	12	00	05	0Hz~ high limit freq	~010C00050FA00280\r	0.01Hz	Forward run boot-strap Set freq. =40.00Hz
	Auxiliary device reverse run with run frequency provision	12	00	06	0Hz~ high limit freq	~010C00060FA00281\r	0.01Hz	Reverse run boot-strap Set freq. =40.00Hz
	Auxiliary device stop	12	00	07	no	~010C0007019B\r	no	
	Auxiliary device jog run	12	00	08	no	~010C0008019C\r	no	
	Auxiliary device forward jog run	12	00	09	no	~010C0009019D\r	no	
	Auxiliary device reverse jog run	12	00	0A	no	~010C000A01A5\r	no	
	Auxiliary device stop run	12	00	0B	no	~010C000B01A6\r	no	
	Auxiliary device failure restoration	12	00	0C	no	~010C000C01A7\r	no	
Software version query order	Query auxiliary device software version	15	00	00	no	~010F00000197\r	1	

Free-Port 2 protocol command table

Name		Mainframe order decimal	Auxiliary index hex	Order index Hex	Run data setting range hex	Mainframe sending example, such as PC control operation of inverter (C language cluster format , auxiliary device is set to 01)	Run data precision	Description
look up auxiliary motor state		10	00	00	no	~010A00000192\r	1	
Run control and adjusting function	Auxiliary device run command	12	00	00	no	~010C00000194\r	no	
	Set current run freq. of auxiliary device	12	00	01	0Hz~high limit freq	~010C00010FA0027C\r	0.01Hz	
	Auxiliary device run with run frequency provision	12	00	02	0Hz~high limit freq	~010C00020FA0027D\r	0.01Hz	
	Auxiliary device forward run	12	00	03	no	~010C00030197\r	no	
	Auxiliary device reverse run	12	00	04	no	~010C00040198\r	no	
	Auxiliary device forward run with run frequency provision	12	00	05	0Hz~high limit freq	~010C00050FA00280\r	0.01Hz	
	Auxiliary device reverse run with run frequency provision	12	00	06	0Hz~high limit freq	~010C00060FA00281\r	0.01Hz	
	Auxiliary device stop	12	00	07	no	~010C0007019B\r	no	
	Auxiliary device jog run	12	00	08	no	~010C0008019C\r	no	
	Auxiliary device forward jog run	12	00	09	no	~010C0009019D\r	no	
	Auxiliary device reverse jog run	12	00	0A	no	~010C000A01A5\r	no	
	Auxiliary device stop run	12	00	0B	no	~010C000B01A6\r	no	
	Auxiliary device failure restoration	12	00	0C	no	~010C000C01A7\r	no	
Software version query order	Query auxiliary device software version	15	00	00	no	~010F00000197\r	1	

Table B-5 read auxiliary device function code parameter

Function definition	Read auxiliary device function code parameter: all function code parameter except user password and manufacturer password except user password and manufacturer password						
Meanings	Frame head	Address	Order	Order index	Run data	Checkout sum	Frame end
Mainframe order	7EH	ADDR	13	See remark	4	BCC	0DH
Byte quantity	1	2	2	4	0	4	1
Auxiliary device respond	7EH	ADDR	06	See remark	Function code parameter	BCC	0DH
Byte quantity	1	2	2	4	4	4	1
remark	Command index=combination of function code group number and hex code of function code number. For instance: If want to read parameter of F0.05 function code, order index=0005; If want to read parameter of F2.11 function code, order index =020B; If want to read parameter of F2.15 function code, order index =020F; If want to read parameter of F2.13 function code, order index =020D;						
	Corresponding relation between decimal and hex value of function code group No.						
	Function code group No	Decimal	Hex	Function code group No	Decimal	Hex	
	F00	0	00H	F0E	14	0EH	
	F01	1	01H	F0F	15	0FH	
	F02	2	02H	F10	16	10H	
	F03	3	03H	F11	17	11H	
	F04	4	04H	F12	18	12H	
	F05	5	05H	F13	19	13H	
	F06	6	06H	F14	20	14H	
	F07	7	07H	F15	21	15H	
	F08	8	08H	F16	22	16H	
	F09	9	09H	F17	23	17H	
	F0A	10	0AH	F18	24	18H	
	F0B	11	0BH	F19	25	19H	
	F0C	12	0CH	F1A	26	1AH	
	F0D	13	0DH	F1B	27	1BH	
Virtual data	0~FFFF (namely 0~65535)						

Please input correct “user password” before you set user function code parameter.

Table B-6 set auxiliary device function code parameter

Function definition	Set auxiliary device function code parameter: all function code parameter except user password and manufacturer password						
Meanings	Frame head	Address	Order	Order index	Run data	Checkout sum	Frame end
Mainframe order	7EH	ADDR	14	See remark	4	BCC	0DH
Byte quantity	1	2	2	4	4	4	1
Auxiliary device respond	7EH	ADDR	06	See remark	Function code parameter	BCC	0DH
Byte quantity	1	2	2	4	4	4	1
Remark	Command index=combination of function code group number and hex code of function code number. For instance: If want to read parameter of F00.05 function code, order index=0005; If want to read parameter of F02.11 function code, order index =020B; If want to read parameter of F02.15 function code, order index =020F; If want to read parameter of F02.13 function code, order index =020D;						
	Corresponding relation between decimal and hex value of function code group No.						
	Function code group No	Decimal	Hex	Function code group No	Decimal	Hex	
	F00	0	00H	F0E	14	0EH	
	F01	1	01H	F0F	15	0FH	
	F02	2	02H	F10	16	10H	
	F03	3	03H	F11	17	11H	
	F04	4	04H	F12	18	12H	
	F05	5	05H	F13	19	13H	
	F06	6	06H	F14	20	14H	
	F07	7	07H	F15	21	15H	
	F08	8	08H	F16	22	16H	
	F09	9	09H	F17	23	17H	
	F0A	10	0AH	F18	24	18H	
	F0B	11	0BH	F19	25	19H	
F0C	12	0CH	F1A	26	1AH		
F0D	13	0DH	F1B	27	1BH		
Virtual data	0~FFFF(namely 0~65535)						

Appendix C Keyboard

C.1 Keyboard selection:

NO.	Type	Details	Remark
1	EN-LED1	Local LED single-display keyboard	Standard
2	EN-LED2	Local LED double-display keyboard	Optional
3	EN-LCD1	Local LCD Keyboard	Optional
4	EN-LCD2	Remote Control LCD Keyboard	Optional
5	EN-LED3-D	Local LED single-display digital potentiometer keyboard (with the function of parameter copy)	Optional

At present, Our has 4 kinds of optional keyboards for our customers' selection, they are EN-LED2, EN-LCD1, EN-LCD2 and EN-LED3-D. Their outer dimension and installation size are the same as the standard keyboard EN-LED1. For more detailed dimension, please refer to "Keyboard Operation and Outer Size of Keyboard installing box" in Chapter 2.



Note

1. EN-LCD1、EN-LCD2、EN-LED3-D are three kinds of keyboard that with the function of parameter copy
2. Using the function of parameter copy could through operating parameter F00.27

C.2 LED double display keyboard

Local LED double display keyboard type: EN-LED2

C.2.1 Keyboard Layout

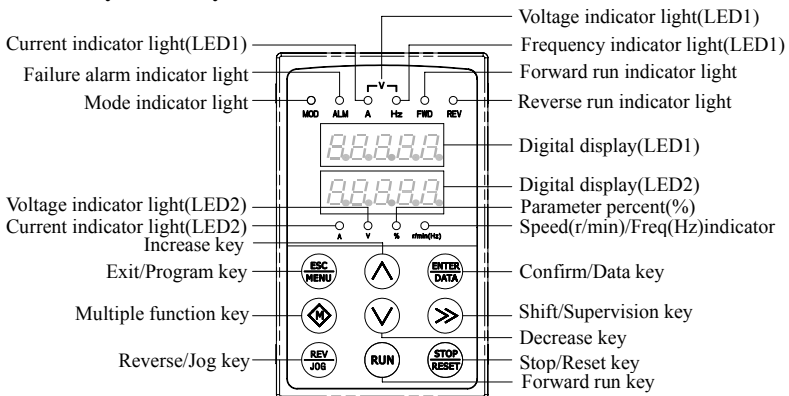

Fig.C-1 EN-LED2 Operating Keyboard Layout

C.2.2 Description for keyboard functions, LED digital tubes and indicator lights

Double-display keyboard consists of two 5-digit digital tube screens, 9 buttons and 10 indicator lights.

If need more details about function definition of the 9 buttons, LED digital tubes and specification of the indicator lights, then please refer to “Keyboard Function Specifications” in Chapter 5.



Note

LED2 digital tube supervision is set by parameter F00.25.

C.3 LCD keyboard

C.3.1 LCD keyboard series:

- (1) Local LCD keyboard type: EN-LCD1
- (2) Remote control LCD keyboard type: EN-LCD2

C.3.2 Keyboard Layout

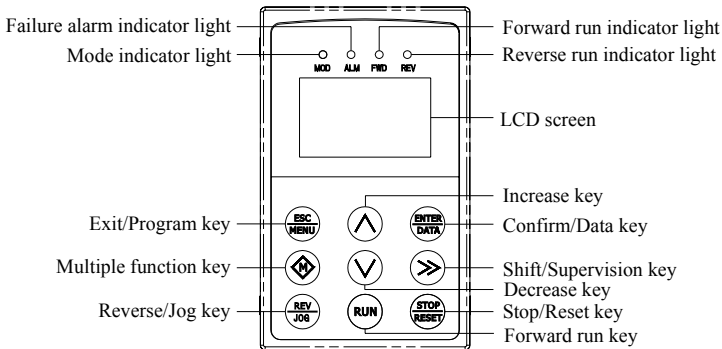

Fig.C-2 Keyboard Layout Sketch (EN-LCD1, EN-LCD2)

C.3.3 Keyboard Function, LCD Display and Spec. of Indicator Lights

LCD keyboard consists of a LCD screen, 9 buttons and 4 indicator lights
 LCD screen: To display Function Setting, Running Supervision, Failure Supervision Code and Parameter.

For more details about function definition of the 9 buttons and specification of the indicator lights, please refer to “Keyboard Function Specifications” in Chapter 5.

C.3.4 Operating Spec. of LCD Display Keyboard

(1) Initialization status of LCD keyboard when power on

When the keyboard is power on, “Key Board” is displayed in the form of animation:

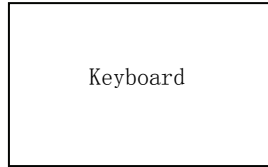

Fig.C-3 Initialization Display when Power On

(2) Operation of switching to firstly menu (Fig. C-4):

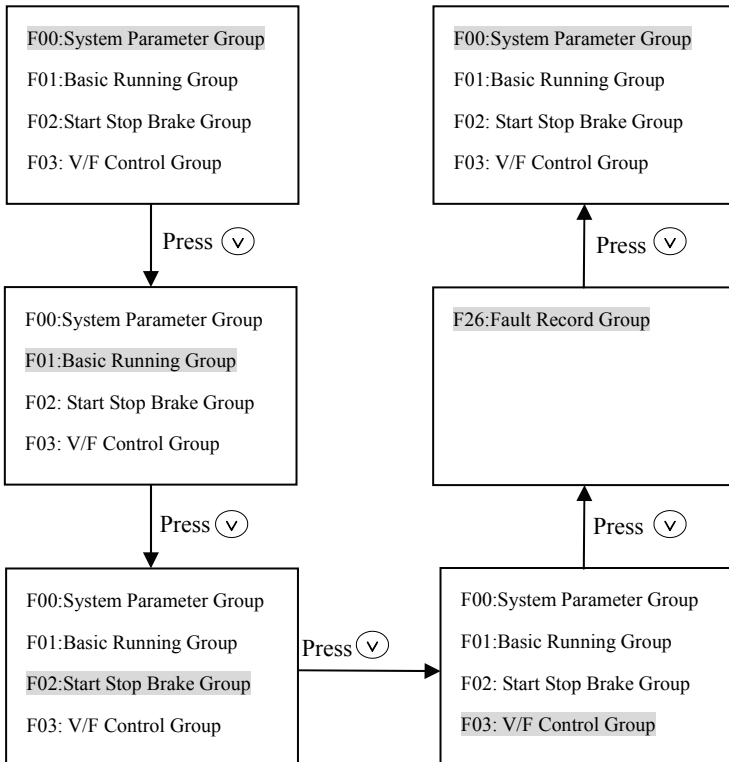

Fig.C-4 Power on initialized display

When set F00.00=2, Senior Menu parameters F00~F27 can be displayed, 28 groups in total. Operation methods are shown as Fig. C-4.

(3) Display and operation of secondary menu:

When you are in the Firstly Menu, choose a parameter group, then press “ENTER/DATA” key and you will enter into the Secondary Menu. Take Parameter F00.00 for example:

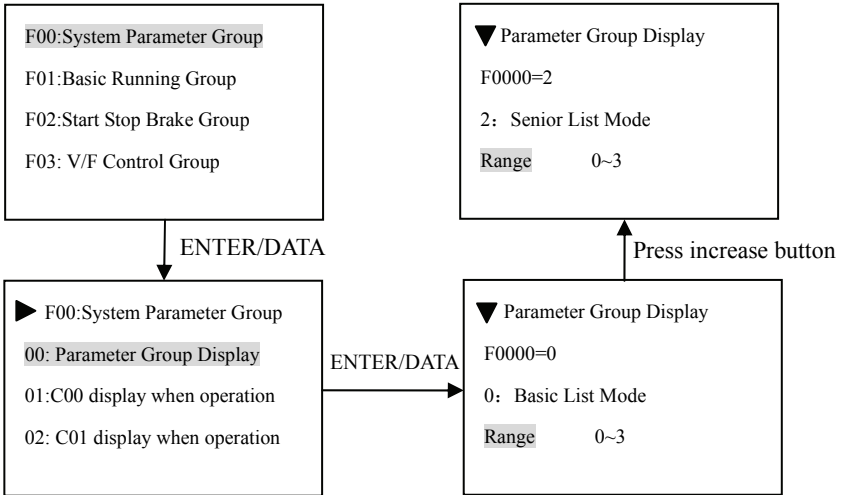

Fig.C-5 Example of Secondary Menu Operation

(4) Function Parameter Operation

Function parameter operation includes the parameter checking, revise and storage of parameters. Before the operating the inverter, parameters should be set correctly. Operation methods are shown as Fig. C-6:

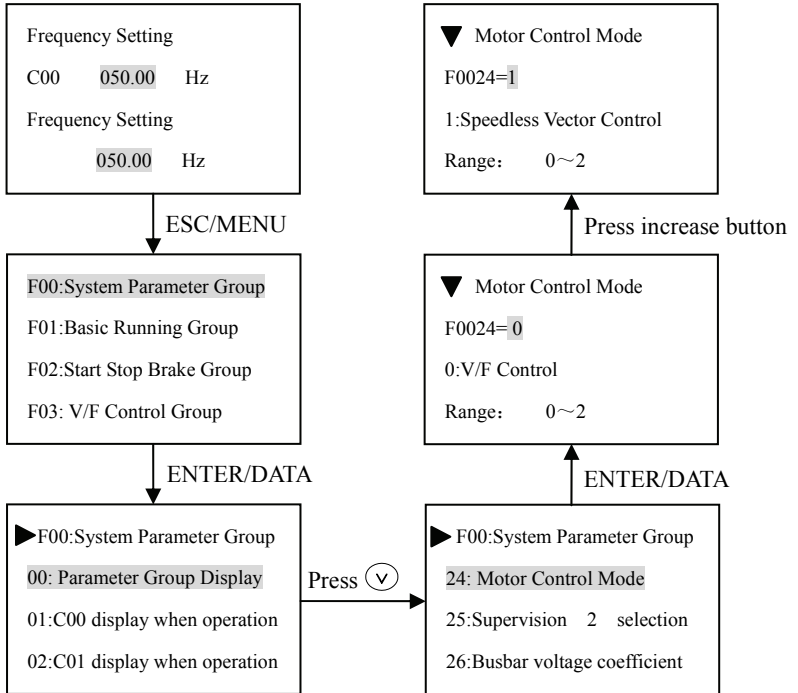

Fig.C-6 Example of function parameter editing

(5) Fault query status

When fault alarm occurs, customers can enter the fault query status:

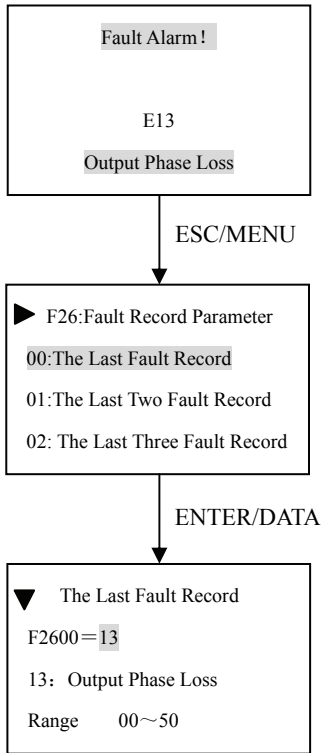

Fig.C-7 Fault query status

C.4 LED single-display digital potentiometer keyboard

The type of local single-display digital potentiometer keyboard: EN-LED3-D。

C.4.1 Keyboard Layout

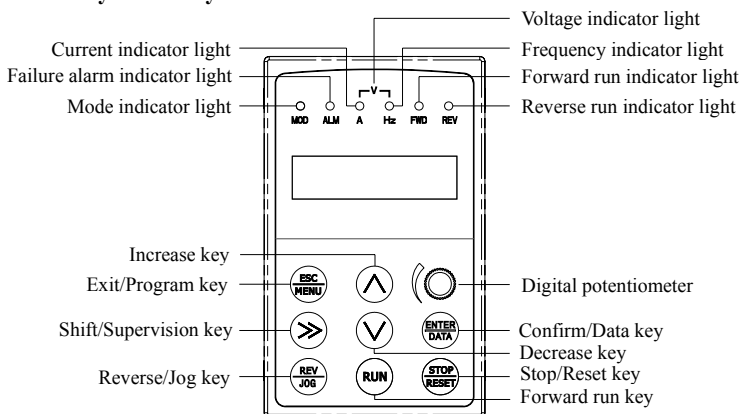

Fig.C-8 EN-LED3-D Operation keyboard layout

C.4.2 Keyboard function、LED Nixie tube and indicator light description

LED single-display digital potentiometer keyboard is composed of a 5-digit nixie tube display、8 keys and a digital potentiometer.

For the function definition of 8 keys in operation keyboard、LED nixie tub and indicator light description, please see also the keyboard function description in chapter 5.

Digital potentiometer function description: it is the same as the function of increase and decrease key, rotate to the left means decrease, rotate to the right means increase.



Note

1. EN-LED3-D operation keyboard is different with the standard configured EN-LED1 in the key site, please pay attention to the key site when using EN-LED3-D
2. EN-LED3-D keyboard is different with other keyboards in unlocking way, unlocking way of EN-LED3-D keyboard is pressing  key for more than 2 seconds.

C.5 Communication Component

The maximum electric distance between keyboard EN-LED1, EN-LED2, EN-LCD1, EN-LED3-D and local inverter is 2m.

RS485 communication mode is adopted between inverter and remote keyboard EN-LCD2, only an ordinary cable is needed to connect each other, and their maximum electric distance can be 1000m. When the communication with each other is main-auxiliary mode, namely take remote keyboard as main device and inverter as auxiliary device. The terminals of the connection cable are made by crystal ends, so it is easy to maintain. Power needs customers' outer leading, the voltage range is from 10V to 24V, the demand current is 150mA, 1mm² of PVC insulate copper wire is suggested to connect.

Following function can be realized by remote keyboard:

- (1) Can control run, stop, jog, failure reset, change setting frequency, modify function parameter and run direction of auxiliary device.
- (2) Can identify the type of auxiliary device. Can monitor the running frequency, setting frequency, output voltage, output current, analog closed loop feedback, analog closed loop setting and exterior counting value of auxiliary device.

Appendix D Communication extension card

D.1 Communication card selection:

At the present, there are four kinds of communication card can be selected for.

Serial No.	Type	Description	Remark
1	EN-PR01	PROFIBUS-DP communication card (use in 15KW and the below)	Optional
2	EN-PR02	PROFIBUS-DP communication card (use in 15KW the above)	Optional
3	EN-CAN1	CANopen communication card	Optional
4	EN-CAN2	CANlink communication card	Optional

D.2 PROFIBUS-DP communication card

D.2.1 PROFIBUS introduction

(1)PROFIBUS (short for Process Field Bus),PROFIBUS is an international and open field bus standard independent with manufacturer. It can be support for many equipment manufacturers, with good compatibility. It's widely used in Manufacturing Automation, automation of process industry, and other buildings, transportation, electric power automation field.

(2)PROFIBUS can realize exchanging the data between all kinds of element of automation, all of this equipment can exchange the information though the same port. But the transmission rate is different .all the automatic equipment can exchange the information though the same port, but with the different rates, so PROFIBUS should offer different types for the speed rates selection. it is made up with PROFIBUS-DP(Distributed peripheral),

PROFIBUS-PA,PROFIBUS-FMS.

(3)PROFIBUS (RS485), the first layer realize the balanced data transmission, wire a bus segment one Bus segment is shielded twisted pair cable, both ends of the segments have a terminating resistor. Transmission mode to half duplex, asynchronous, synchronous gap-free data exchange basis, the physical layer supports fibre, the data frame 11, and the transfer rate: 9.6Kbit / sec-12Mbit / sec. Bus length range from 100 to 1200 meters

(4)Between same-level controller and PC communications (token passing procedure), to ensure adequate opportunity to deal with their communication tasks in a determined time. Complex PLC and PC with a simple division formula I / O communications, you must quickly and with minimal protocol overhead (master - slave program)

D.2.2 The external form of PROFIBUS-DP and terminal definition description

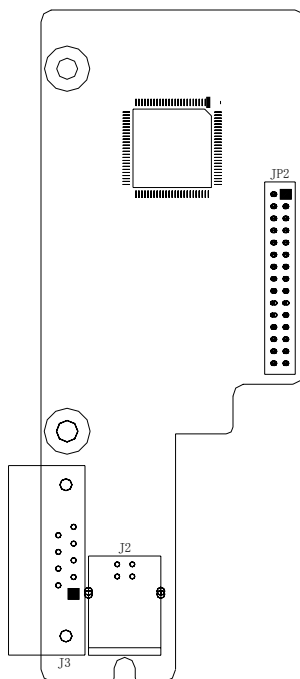
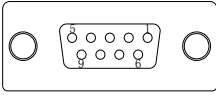

Fig D-1 PROFIBUS-DP outline dimensional drawing

Table D-1 Terminal function description

Terminal date	Name	Description	Remark
J2	USB form adapter plugs	USB connection factory and distribution to DB9 adapter cable	Use it on 15KW frequency inverter or below
J3	DB9 communication port	communication signal connection interface,9-pin DB9 female.	Use it on 15KW frequency inverter or the above
JP2	Board-level docking connector	When you install this plug docking with the main control board CN2	

(1) J3 Plug pin definition :



PIN data	Definition	PIN data	Definition
1	bit bare	6	VCC
2	bit bare	7	bit bare
3	Communication signal A	8	communication signal B
4	bit bare	9	bit bare
5	GND	-	-

(2) J2 Plug pin definition :

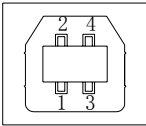

PIN data	Definition	PIN data	Definition
1	Communication signal A	3	GND
2	Communication signal B	4	VCC

(3) J2 switch wiring

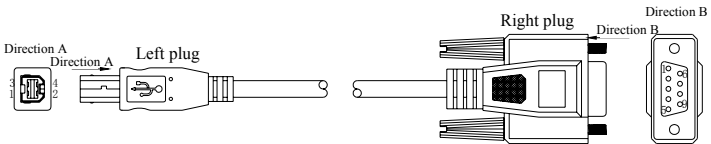

Table D-2 The left end plug and The right end plug PIN data

The left end plug PIN data	The right end plug PIN data	The left end plug PIN data	The right end plug PIN data
-	1	4	6
-	2	-	7
1	3	2	8
-	4	-	9
3	5	-	-

D.3 CANopen communication card

D.3.1 CANopen introduction

CANopen is an architecture in the control area network (Controller Area Network, CAN) on the high-level communication agreements, including communication equipment sub-sub-agreements and agreements, often used in embedded systems, industrial control is a commonly used fieldbus. CANopen implements the network layer and above the agreement OSI model. CANopen standard includes addressing scheme, several small communication sub-agreements

D.3.2 Equipment model

Communication agreement on other modules communication processing and network communication unit needed to start and reset the device has a state machine control. State machine include: Initialization, Pre-operational, Operational, Stopped.

D.3.3 Object Dictionary

Object Dictionary (OD: Object Dictionary) is an ordered group of objects; each object using an index value of 16 is addressed, in order to allow access to the data structure of a single element, while the definition of an eight sub-indexes.

D.3.4 Communication

- (1)Communication objects: Management packets, Service Data Objects (SDO), process data objects (PDO), the pre-definition packet or special function object
- (2)Communication model: master/slave model, client/server model, producer/consumer model

D.3.5 Agreement

- (1) NMT Agreement (network management, network management): Status Agreement definition of the state machine change commands (such as starting or stopping the equipment), to detect remote device bootup and failure scenarios.
- (2) Heartbeat Agreement: nodes in the network to monitor and confirm it is working properly.
- (3) SDO agreement: between devices used to transfer large low-priority data, typically used to configure devices on the CANopen network.
- (4) PDO Agreement: 8 bytes or less used to transmit data, no other agreement preset (which means data has been pre-definition).

D.3.6 CANopen form and terminal definition description

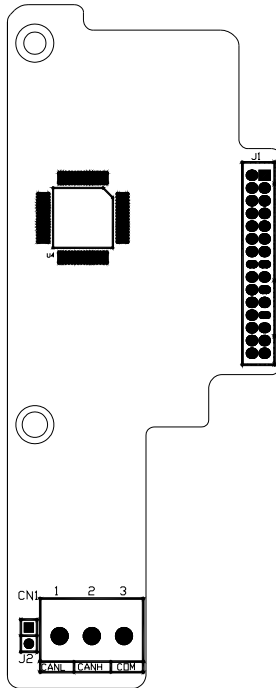

Fig D-2 CANopen outline dimensional drawing

Table D-3 Terminal function description

Terminal number	Name	Description	Remark
CN1	Communication wiring terminal	By the client device connected to the CAN bus communication	
J1	Signal port	When you install this plug docking with the main control board CN2	
J2	Terminal resistor access entry	Connect J2, then terminal resistor connect to bus	

(1)CN1 pin definition

PIN data	Definition	PIN data	Definition
1	signal CANL	3	COM
2	signal CANH	-	-

D.4 CANlink communication card

D.4.1 CANlink introduction

The physical layer CANlink card is CAN bus, only supports CAN2.0B extended frame. Since the control signal CANlink card connected directly to the main board, compared with CANOPEN card, with high transmission efficiency, real-time, stability and other characteristics, the maximum transfer rate of 1Mbps. CAN bus data transmission using a differential signal, with strong anti-interference, transmission distance and other characteristics, the communication rate 5Kbps below, the farthest reach 10Km, at 1Mbps baud rate up to 30m.

CANlink protocol is self-definition protocols, support for modifications and inverter terminal parameters monitoring.

D.4.2 CANlink card figure and terminal definition description

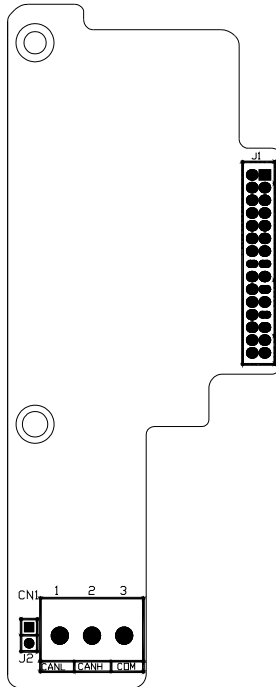

Fig D-3 CANlink Dimensions

Table D-4 Terminal function description

Terminal Number	Name	Description	Remark
CN1	Communication wiring terminal	By the client device connected to the CAN bus communication	
J1	Signal port	When you install this plug docking with the main control board CN2	
J2	Terminal resistor access entry	Connect J2, then terminal resistor connect to bus	

(1) The definition of CN1 pin.

PIN data	Definition	PIN data	Definition
1	Signal CANL	3	COM
2	Signal CANH	-	-

Appendix E Universal encoder expansion card

E.1 The selection of encoder expansion card:

Universal encoder expansion card (PG card), As an option to use, it is the necessary option for closed loop vector control inverter.

No.	Model	Description	Remark
1	EN-PG01	Differentiator input PG card, encoder input signal not isolated (suitable for all series machine)	Optional
2	EN-PG02	Differentiator input PG card, encoder input signal through the optocoupler isolation, stronger anti-interference ability (suitable for all series machine)	Optional

E.2 PG card shape and terminal definitions

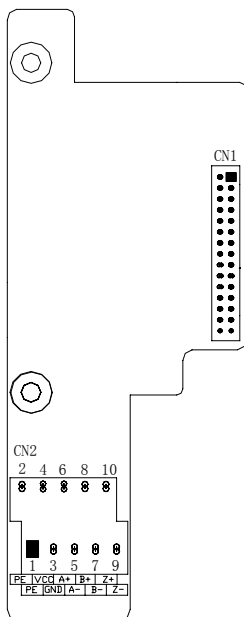

Fig.E-1 EN-PG01, EN-PG02 Outline dimension drawing

Table E-1 Terminal function description

Terminal number	Name	Description	Remark
CN1	Board and board Butt socket	When installing the plug and the main control board CN2 docking	
CN2	The user interface	The encoder uses	

(1) CN2 Terminal definitions

PIN data	Terminal labeling	Description
1	PE	Shielding terminal
2	PE	Shielding terminal
3	GND	Power supply (GND of EN-PG01 and GND of control panel is connect. GND of EN-PG02 and GND of control panel isolation)
4	VCC	Provide 5V/300mA current toward outside
5	A-	Encoder output signal A negative
6	A+	Encoder output signal A positive
7	B-	Encoder output signal B negative
8	B+	Encoder output signal B positive
9	Z-	Encoder output signal Z negative
10	Z+	Encoder output signal Z positive

(2) PG card specification:

The user interface	Terminal table
Spacing	3.81mm
The maximum rate	500kHz
Differentiator input signal amplitude	≤7V

Appendix F Braking unit and braking resistance

F.1 Braking unit and braking resistance

The motor's electric potential energy will charge inverter's capacitance up reversely if speed of the motor descends too quickly or load of the motor wobbles too quickly while the inverter is running, which will increase the voltage upon power modules suddenly and is easy to make the inverter damaged. The inverter will control it according to load size and performance. You only need to connect external braking resistance to realize timely energy discharge when the braking function is needed. To connect external resistance is a kind of energy consumption braking mode, as all the energy is consumed by the braking resistance.

EN600-2S0037, EN600-4T0007G/0015P ~ EN600-4T0150G/0185P has been configured the built-in braking unit for EN600-2S0004 ~ EN600-2S0022, EN600-4T0185G/0220G ~ EN600-4T0550G/0750P, the built-in braking unit is optional.

When braking function needed, please connect external braking resistance according to below table.

Configuration table of braking unit and braking resistor configuration as well as circumscribed braking resistor

Frequency inverter type	Built-in braking unit	Built-in braking resistor	Add braking resistor	Quantity	Power of braking resistor (50% braking rate)	Power of braking resistor (10% braking rate)
EN600-2S0004	Optional	无	$\geq 150\Omega$	1PCS	$\geq 1KW$	$\geq 200W$
EN600-2S0007	Optional	无	$\geq 100\Omega$	1PCS	$\geq 1.5KW$	$\geq 250W$
EN600-2S0015	Optional	无	$\geq 70\Omega$	1PCS	$\geq 2KW$	$\geq 400W$
EN600-2S0022	Optional	无	$\geq 50\Omega$	1PCS	$\geq 3KW$	$\geq 600W$
EN600-2S0037	Built-in	无	$\geq 30\Omega$	1PCS	$\geq 5KW$	$\geq 1KW$
EN600-4T0007G/0015P	Built-in	No	$\geq 300\Omega$	1PCS	$\geq 1KW$	$\geq 250W$
EN600-4T0015G/0022P	Built-in	No	$\geq 300\Omega$	1PCS	$\geq 1KW$	$\geq 250W$
EN600-4T0022G/0037P	Built-in	No	$\geq 300\Omega$	1PCS	$\geq 1KW$	$\geq 250W$
EN600-4T0037G	Built-in	No	$\geq 125\Omega$	1PCS	$\geq 2KW$	$\geq 400W$
EN600-4T0055P	Built-in	No	$\geq 125\Omega$	1PCS	$\geq 2KW$	$\geq 400W$
EN600-4T0055G/0075P	Built-in	No	$\geq 80\Omega$	1PCS	$\geq 3.8KW$	$\geq 750W$
EN600-4T0075G/0110P	Built-in	No	$\geq 80\Omega$	1PCS	$\geq 3.8KW$	$\geq 750W$
EN600-4T0110G/0150P	Built-in	No	$\geq 50\Omega$	1PCS	$\geq 5KW$	$\geq 1KW$
EN600-4T0150G/0185P	Built-in	No	$\geq 40\Omega$	1PCS	$\geq 7.5KW$	$\geq 1.5KW$
EN600-4T0185G/0220P	Optional	No	$\geq 27\Omega$	1PCS	$\geq 9KW$	$\geq 1.8KW$

EN600-4T0220G/0300P	Optional	No	$\geq 22\Omega$	1PCS	$\geq 11KW$	$\geq 2.2KW$
EN600-4T0300G/0370P	Optional	No	$\geq 19\Omega$	1PCS	$\geq 15KW$	$\geq 3KW$
EN600-4T0370G/0450P	Optional	No	$\geq 16.8\Omega$	1PCS	$\geq 18.5KW$	$\geq 3.7KW$
EN600-4T0450G/0550P	Optional	No	$\geq 13\Omega$	1PCS	$\geq 22KW$	$\geq 4.5KW$
EN600-4T0550G/0750P	Optional	No	$\geq 11\Omega$	1PCS	$\geq 28KW$	$\geq 5.5KW$



Address: 5-6F, Bldg.4, Minqi Technology Park,
Lishan Rd., Nanshan Area, Shenzhen 518055, China

E-mail: encvfd@encvfd.com

Website: <http://www.encvfd.com>